

LOW VOLTAGE AC DRIVES

ABB general purpose drives

ACS580, 0.75 to 500 kW



**Easiness.
Reliability.
Scalability.
ACS580 series.**

Table of contents

004	The all-compatible ACS580 series
006	Switch on simplicity without trading off efficiency
008	What does all-compatible mean for your application?
010	Typical applications
011	Complete offering from wall-mounted drives to cabinet installations
012	Common features throughout the whole ACS580 product family
013	Standard ACS580 drives software with versatile features
014	Standard interface and extensions for plug-in connectivity
015	How to select a drive
016	Technical data
017	Dimensions
018	Ratings, types and voltages
020	Control panel options
021	Additional options
022	Connectivity options
023	EMC – electromagnetic compatibility
024	Cooling and fuses
026	du/dt filters
028	ABB automation products
029	Save time, ease troubleshooting and improve drive performance with ABB smartphone apps
030	Services to match your needs
031	Drives service
032	A lifetime of peak performance

The all-compatible ACS580 series

Effortless energy efficiency

The ACS580 is an all-compatible ABB general purpose drive, offered in a range of wall-mounted drives, drive modules and cabinet-built drives. It turns complicated to simple to control processes efficiently.

One product, many applications

ACS580 drives include all the essential components for typical light industry applications, with a scalable offering from 0.75 kW to 500 kW. The drive is ready to control compressors, conveyors, mixers, pumps and fans, as well as many other variable and constant torque applications.

The drive controls a wide range of applications in different industries, and yet it requires very little setting up or commissioning.

Reliability and consistent high quality

ACS580 drives are designed for customers who value high quality and robustness in their applications. The product features, such as coated boards and compact IP55 enclosure, make the ACS580 suitable also for harsh conditions. Additionally, all ACS580 drives are tested at maximum temperature and with nominal loads. The tests include performance and all protective functions.

Easier than ever before

ACS580 drives have all the essential features built-in reducing the commissioning and setup time. The assistant control panel with 16 different languages is standard in ACS580 drives, and users can upgrade to an optional Bluetooth control panel for wireless commissioning and monitoring. Primary settings and control macros help in the quick product setup. The compact design makes handling the units easy.

Instant availability

ACS580 products are available from central stocks around the world for immediate delivery up to 500 kW. The product is also widely available from ABB distributors globally.

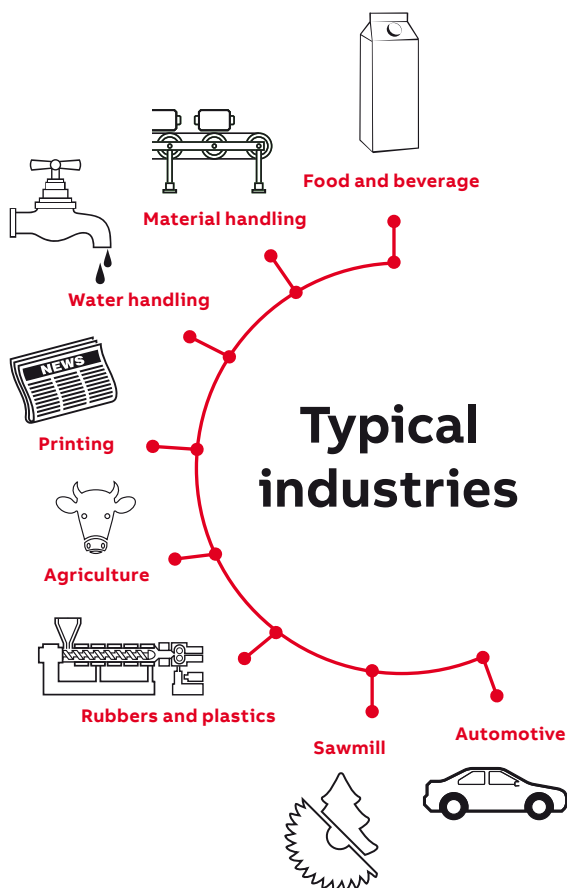



Switch on simplicity without trading off efficiency

The ACS580 general purpose drive is equipped with built-in features that simplify ordering and delivery, and reduce commissioning costs, since everything is provided in a single, compact and ready-to-use package.



Startup and maintenance tool

Drive composer PC tool for startup, configuration, monitoring and process tuning. The PC tool is connected to the drive's control panel via a USB interface.

Simple to select, install and use

Built-in features such as an EMC filter, choke, a Modbus RTU fieldbus interface and safe torque off functionality simplify drive selection, installation and use.



Simplicity at your fingertips as standard

The control panel's straightforward primary settings menu with assistants help you set up the drive quickly and effectively.

Scalable performance

The ACS580 is a perfect match not only for energy-aware applications, but also for applications where sophisticated speed and torque control are needed.



—
ACS580 drives are designed for maximum reliability.



Communication with all major automation networks

Optional fieldbus adapters enable connectivity with all major industrial automation networks.



Reliable, integrated safety

The ATEX-certified thermistor protection module option CPTC-02 provides enhanced process safety and easy, simplified installation.



Adaptive programming

Adaptive programming is ideal for creating simple programs for various applications. It does not require expertise in programming.



Designed for maximum reliability

Design features like coated circuit boards, minimized airflow through the control board section, earth fault protection and design for 50 °C ambient temperature make the ACS580 a safe choice.



Remote monitoring

With a built-in web server and stand-alone datalogger NETA-21 module enables worldwide and secure access to drives.

What does all-compatible mean for your application?

Business all-compatible

The all-compatible drives are not just equipment – they are part of your business strategy. Whether your target is to optimize the productivity of your business or scale it from local to global, all-compatible is there for you. Shared elements throughout the product offering make the transition from one product to another easy. With offices in over 90 countries and a global network of technical partners, we are in a good position to offer technical advice and local support, worldwide.

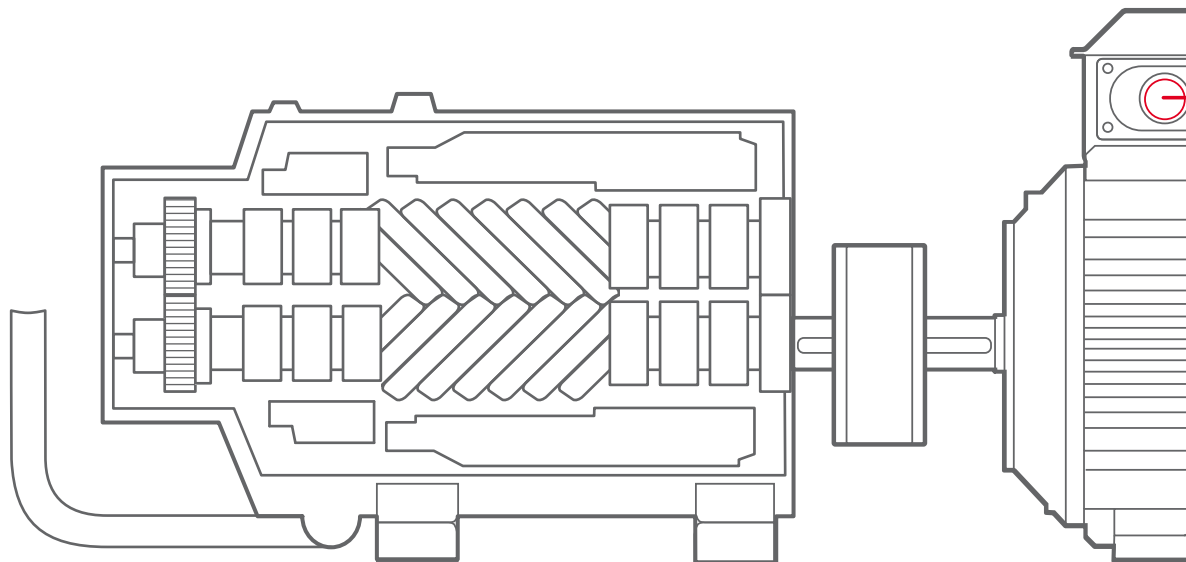

Process all-compatible

The drives are compatible with all kinds of processes. They can control virtually any type of AC motor, provide extensive input/output connectivity and support all major fieldbus protocols. The drives cover a wide voltage and power range. The flexibility and scalability of the drives enable one drive platform to control almost any application or process, making your drive selection easy.

Environment all-compatible

There is increased demand for industries to reduce their impact on the environment. Our drives can help you reduce energy consumption in a wide range of applications. Our drives have an energy optimizer feature that ensures maximum torque per ampere, reducing energy drawn from the supply. The built-in energy efficiency calculators help you to analyze and optimize your processes. We can help you to investigate the energy-saving potential of selected applications with our energy appraisal.

Our wall-mounted ACS580 general purpose drives fulfill the highest IE2 drive (EN 50598-2) energy efficiency class, further reducing environmental impact. In addition, all ACS580 general purpose drives are compatible with high-efficiency IE4.

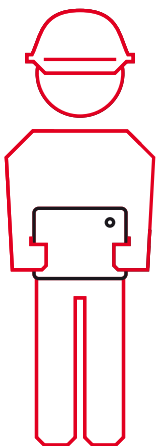
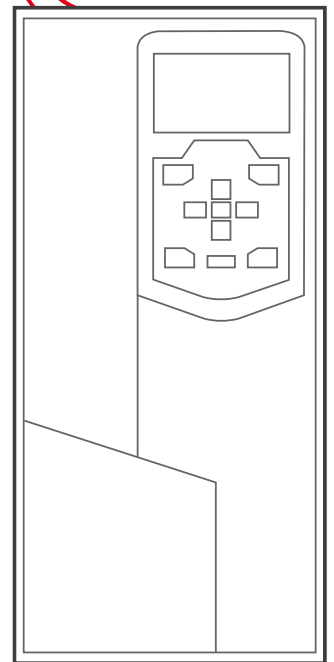
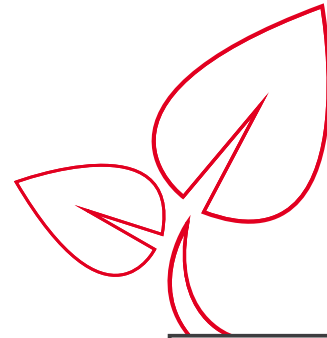
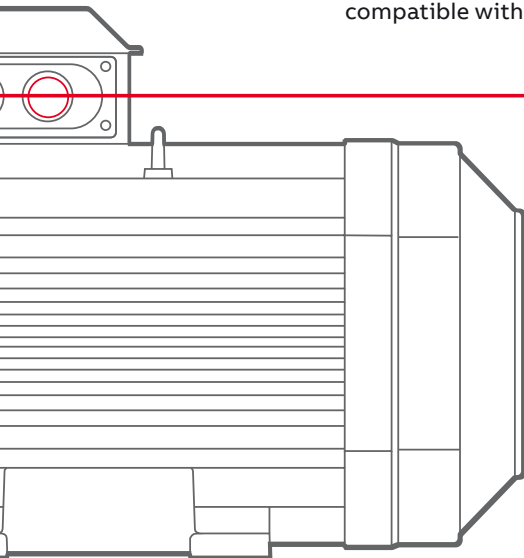

Human all-compatible

All our drives share easy-to-use interfaces, saving you time during drive commissioning and maintenance. When you have learned it once, you can use it with all the drives in our all-compatible drives portfolio.

The control panel supports 16 languages. With the PC tool, you get extensive drive monitoring capabilities and quick access to the drive settings. Integrated and certified safety features provide safety for machine operators. To further improve the user experience, we have developed mobile apps that can be utilized in interacting with the drive. These apps give you an easy graphical interface for management, maintenance and servicing of your drives.

Typical applications

ACS580 drives improve process performance, increase productivity and ensure machine and personnel safety

Industry	Application	Customer benefits
Food and beverage	Blowers, centrifuges, compressors, conveyors, fans, mills, pumps, separators, mixers, dryers, pelletizers	<ul style="list-style-type: none"> - Accurate control of the process increases the speed of food production while saving energy and improving work safety. Precise speed and torque control increases production uptime even when the load varies. - Increased starting torque with boost function allows the same drive series to be used in different applications in the manufacturing plant. - Safe torque off (SIL 3) function ensures machine and personnel safety. - The easy-to-use control panel with 16 different languages and robust design reduces the time needed for maintenance. - The ATEX-certified thermistor protection module meets the safety requirements even in dusty environments.
Material handling	Conveyors	<ul style="list-style-type: none"> - Accurate and precise speed and torque control increase production uptime even when the load varies. - Safe torque off (SIL 3) function ensures machine and personnel safety. - Minimized downtime with robust and reliable design. - Swinging choke technology to mitigate harmonics. - External +24 V supply to keep the communication up when the mains supply is disconnected.
Printing	Compressors, presses, winders	<ul style="list-style-type: none"> - Smooth acceleration to prevent breaking the paper. - The robust design of the drive reduces mechanical stress on process line equipment, lowering maintenance costs and capital expenditure. - Precise speed and torque control of applications increases process uptime by optimizing motor control.
Rubber and plastics	Extruders, injection molding machines, pumps	<ul style="list-style-type: none"> - Smooth acceleration to prevent breaking the web of plastic film. - The scalable all-compatible platform allows easy process and component optimization with different drive types that share the same user interface and tools. - Wide range of supported fieldbus protocols for easy PLC integration.
Textile	Bleaching machines, compressors, conveyors, drum washers, extruders, fans, jet dyeing machines, pumps, stenter machines, stretchers, winders	<ul style="list-style-type: none"> - Precise speed or torque control for high stretching accuracy and better quality of the end product. - Adjustable torque limit to prevent damage to mechanical equipment. - Adjustable accel/decel ramps to improve pump control. - Real-time clock and timed functions for process optimization. - Increased productivity and faster payback times with multiple setups, allowing production of two different products. - Built-in counters for additional energy savings and preventive maintenance.
Sawmill	Chippers, conveyors, feeders, dryers, pickers, drying kilns	<ul style="list-style-type: none"> - IP55/UL type 12 available up to 250 kW for harsh environments. - Cabinet-built drive IP54 up to 500 kW. - Safe torque off (SIL 3) function ensures machine and personnel safety. - External +24 V supply to keep the communications "alive" when the mains supply is turned off. - ATEX-certified thermistor protection module.
Water handling	Compressors, pump stations	<ul style="list-style-type: none"> - Additional energy savings with energy optimizer function. - Adjustable accel/decel ramps to improve pump control. - Minimized downtime with robust and reliable design. - ABB's extensive product and service offering for comprehensive process optimization.
Agriculture	Fans, irrigators, pumps, sorters	<ul style="list-style-type: none"> - IP55/UL 12 available up to 250 kW harsh environments. - Wall-mounted power range up to 250 kW. - Drive modules and cabinet-built drives up to 500 kW.
Automotive	Conveyors, fans, pumps	<ul style="list-style-type: none"> - ATEX-certified thermistor protection module. - Increased productivity and faster payback times with multiple setups. - Enhanced quality of end products with smooth control of the motor and process. - Safe torque off (SIL 3) function ensures machine and personnel safety. - Wide range of fieldbus networks supported, including PROFIBUS and PROFINET IO. - P55/UL 12 available up to 250 kW 400 V and high enclosure rating for harsh environments. - The robust design of the drive reduces mechanical stress on process line equipment, lowering maintenance costs and ensuring high production quality.

Complete offering, from wall-mounted drives to cabinet installations

No matter the frame size or power range, all ACS580 drives bring you ease of use, scalability and quality.

—
01 Wall-mounted
ACS580 IP21 drive

—
02 Wall-mounted
ACS580 IP55 drive

—
03 ACS580 drive
module with IP00

—
04 Cabinet-built ACS580
drive with IP42

Wall-mounted IP21 drives

Wall-mounted IP21 drives are available in a power and voltage range from 0.75 to 250 kW and 3-phase 380-480 V. Side-by-side mounting, flange mounting and horizontal mounting are all available for wall-mounted ACS580 drives.

Wall-mounted IP55 drives

The IP55 drive is designed for applications exposed to dust, moisture, vibrations and other harsh environments. It is similar in size to the compact IP21 drives, which provides significant savings in space, maintenance, engineering, and material costs, as well as in setup and commissioning time.

Drive modules for cabinet installations

ACS580 drive modules are optimal for system integrators, cabinet builders or OEMs who want to optimize the cabinet design in the 250-500 kW range, but do not want to compromise on easy installation, commissioning and maintenance.

Cabinet-built drives

Cabinet-built drives are available with IP21 protection class as standard and IP42/54 as options in frame sizes R6 to R9. IP42 protection class is standard in frame sizes R10-R11. The drives have a new cooling arrangement and a global cabinet design with a high quality standard. The power and voltage range is from 75 kW to 500 kW, 3-phase 380-480 V.



—
01



—
02



—
03



—
04

Common features throughout the whole ACS580 product family



Standard ACS580 features

Choke and EMC

- Swinging choke technology to mitigate harmonics
- Fulfills standard the EN61000-3-12 standard
- EMC C2 filter allows installation in first environment

Scalar and vector control for process control

- Scalar control for effortless process control
- Vector control for accurate and energy-efficient speed and torque control in demanding applications
- Support for induction, permanent magnet and synchronous reluctance motors (SynRM)

Extensive I/O connections

- The ACS580 features extensive I/O connections for flexible configuration in various applications
- Colored terminals for easy configuration

Assistant control panel and primary settings

- The ACS-AP-S assistant control panel speaks 16 different languages
- USB interface for PC and tool connection
- Help button for problem-solving

Integrated safe torque off (STO)

- Safe torque off for implementing safe machinery
- SIL 3, PL e

Brake chopper

- The brake chopper is built-in as standard for ACS580 frames up to R3. Braking control is integrated into ACS580 drives.

Performance

- The ACS580 is suitable not only for variable torque applications but also for basic constant torque applications



Shared features of the ABB all-compatible drives portfolio

Adaptive programming

- ACS580 firmware includes an easy-to-use and visual adaptive programming feature.
- Adaptive programming can be used to add logical functions and conditions for process fine-tuning.

Same PC tools for ABB all-compatible drives

- Free Drive Composer entry available at www.abb.com.
- Same parameter structure makes the all-compatible platform easy to use.

ATEX-certified PTC thermistor support

- The ACS580 can be equipped with an optional CPTC-02 ATEX-certified PTC sensor.
- The safety integrity level for the CPTC-02 module is SIL 2/PL c.

Connectivity

- The ACS580 supports F-series fieldbus adapters used in the ABB all-compatible platform.
- Mobile phone connectivity via the optional Bluetooth assistant control panel.
- Fieldbus settings are made easy with the redesigned simple settings menu.

Standard ACS580 drives software with versatile features

Save commissioning and learning time with the assistant control panel's clear and intuitive user interface and different assistants.

Improve the performance of the motor and process with sophisticated process control in scalar and vector control modes. The drive supports a wide range of motors, including induction and permanent magnet motors.

Analyze and optimize the application with the load profile log, which shows you how the drive is operating.

Reduce motor noise with spreading the switching frequencies over a user-specified range.

Reduce costs with the built-in and standalone process PID. It makes the ACS580 a self-governing unit requiring only an external process measurement. No external logic input from the control room is needed.

Scale up and customize the drive to your application's requirements with flexible parameter pointers or adaptive programming.

Optimize energy efficiency with features that help you to save and manage energy. You can monitor the hourly, daily and cumulative energy consumption via kWh counters.

Analyze and resolve issues with the control panel's diagnostics menu. You can quickly analyze why the drive is performing as it is; running, stopped or running at the present speed.

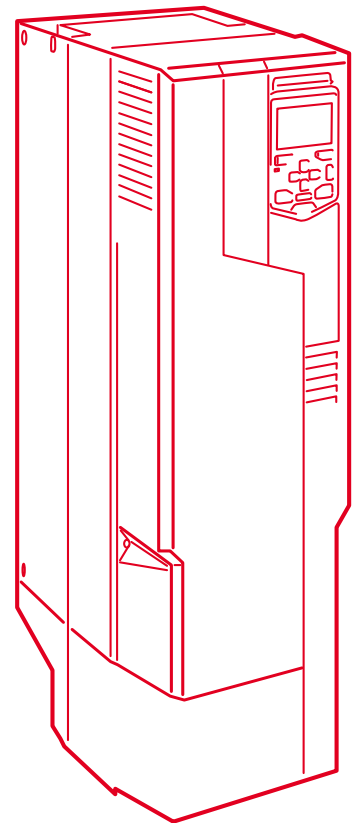

Standard interface and extensions for plug-in connectivity

ACS580 drives offer a wide range of standard interfaces. In addition, the drive has two option slots that can be used for extensions, including fieldbus adapters and input/output extension modules that allow an external +24 V supply with frame sizes R1 to R5. For further information, please see the ACS580 user manual.



Default factory I/O connection diagram

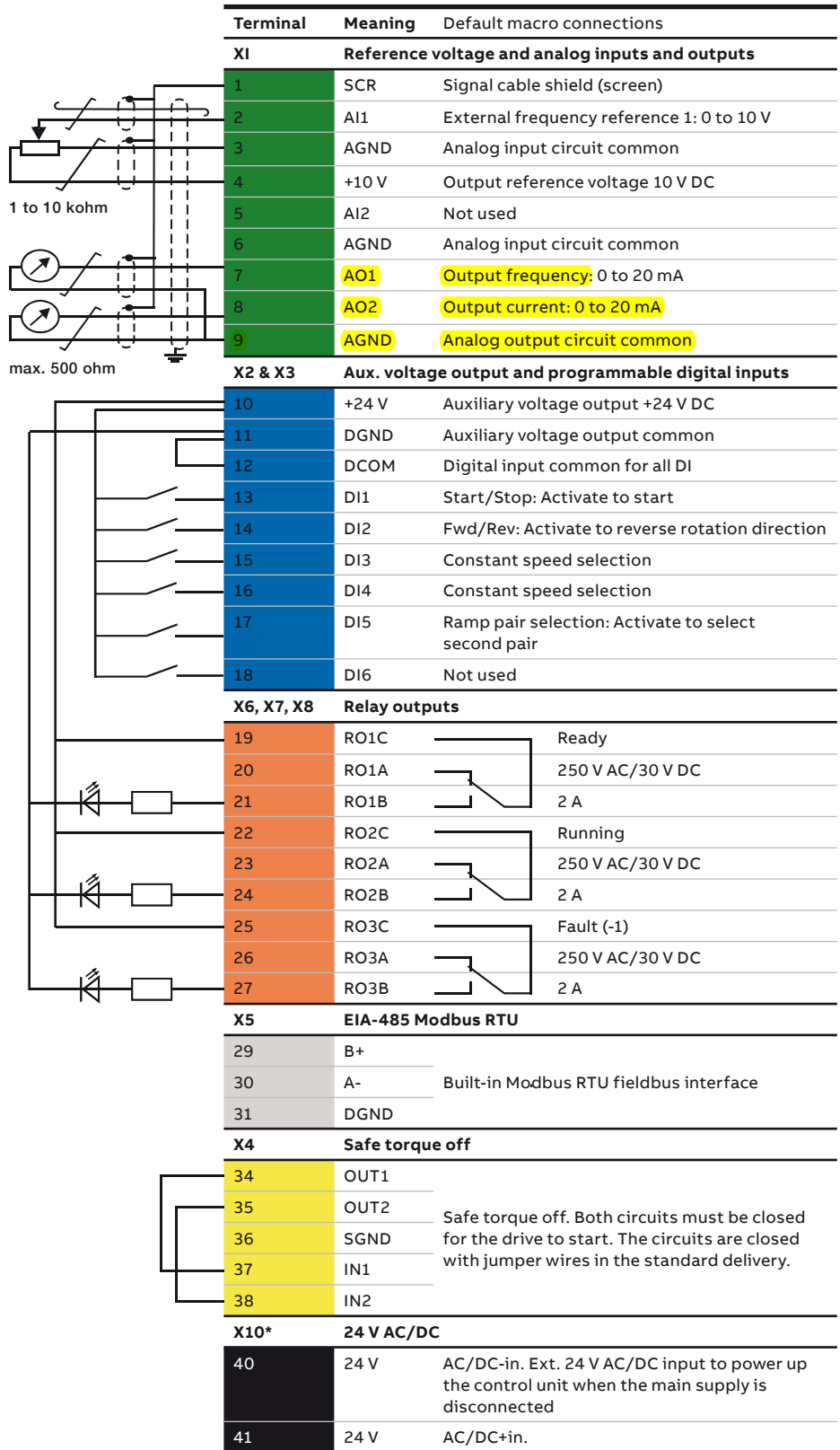

* The terminals 40-41 are integrated in the frame sizes R6-R11. For the frame sizes R1-R5 I/O options (+L) are needed.

How to select a drive

The right drive is extremely easy to select. The following instructions show you how to order the right drive for your application.

Start by identifying your supply voltage. Based on the supply voltage, follow either the right side or the middle section of the rating table. See pages 18 and 19.

1

Choose your motor's power and current rating from the rating table on pages 18 and 19.

2

Select your drive's order code from the rating table based on your motor's nominal power rating.

3

Ratings, types and voltages

Table with columns for Motor power (kW), Motor current (A), Drive power (kW), Drive current (A), and various efficiency and speed ratings. A red box highlights a specific section of the table.

Pages 18 and 19

Table with columns for Motor power (kW), Motor current (A), Drive power (kW), Drive current (A), and various efficiency and speed ratings. A red box highlights a different section of the table.

Pages 18 and 19

Choose your options (on pages 20 and 21) and add the option codes to the drive's order code. Remember to use a "+" mark before each option code.

4

Control panel options

Table listing various control panel options such as 'Advanced control panel', 'Basic control panel', and 'Smart control panel'. A red box highlights a specific section of the table.

Pages 20 and 21

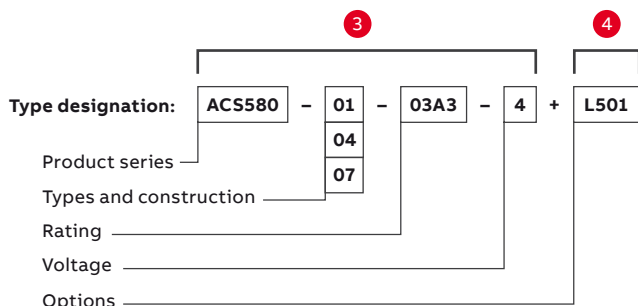

Technical data

Mains connection		Environmental limits	
Voltage and power range	3-phase, U_N 380 to 480 V, +10%/-15% ACS580-01: from 0.75 up to 250 kW ACS580-04: from 250 up to 500 kW ACS580-07: from 75 up to 500 kW	Ambient temperature	
Frequency	from 48 to 63 Hz	Transport	-40 to +70 °C
Power factor	$\cos\varphi = 0.98$	Storage	-40 to +70 °C
Efficiency (at nominal power)	98%	Operation area	ACS580-01: -15 to +50 °C. No frost allowed R1 to R9 from +40 to +50 °C with derating ACS580-04: -15 to +55 °C. No frost allowed R10 to R11 from +40 to +55 °C with derating ACS580-07: 0 to +40 °C. No frost allowed R6 to R11 from +40 to +50 °C with derating
Motor connection		Cooling method	
Voltage	0 to U_N , 3-phase	Air-cooled	Dry clean air
Frequency	0 to 500 Hz	Altitude	
Motor control	Scalar and vector control	0 to 1,000 m	Without derating
Torque control	Torque step rise time: <10 ms with nominal torque Non-linearity: $\pm 5\%$ with nominal torque	1,000 to 4,000 m	With derating of 1%/100 m
Speed control	Static accuracy: 20% of motor nominal slip Dynamic accuracy: 1% seconds with 100% torque step	Relative humidity	5 to 95%, no condensation allowed
Product compliance		Degree of protection	ACS580-01: IP21 as standard. IP55 as option (frames R1 to R9) ACS580-04: IP00 as standard. IP20 as option (frames R10 to R11) ACS580-07: Cabinet-built frames R6 to R9: IP21 as standard. IP42 and IP54 as options Cabinet-built frames R10 to R11: IP42 as standard and IP54 as option
CE Low Voltage Directive 2006/95/EC, EN 61800-5-1: 2007 Machinery Directive 2006/42/EC, EN 61800-5-2: 2007 EMC Directive 2004/108/EC, EN 61800-3: 2004 + A1: 2012 RoHS directive 2011/65/EU ACS580-07 (R10–R11) CE Quality assurance system ISO 9001 and Environmental system ISO 14001 Waste electrical and electronic equipment directive (WEEE) 2002/96/EC RoHS directive 2011/65/EU UL, EAC, RCM, UL, cUL		Functional safety	Safe torque off (STO according EN 61800-5-2) IEC 61508 ed2: SIL 3. IEC 61511: SIL 3. IEC 62061: SIL CL 3. EN ISO 13849-1: PL e
EMC according to EN 61800-3: 2004 + A1: 2012		Contamination levels	No conductive dust allowed
Frames R1 to R9 with built-in C2 category filter as standard Frames R10 and R11 with preconfigured built-in C3 category filter option		Storage	IEC 60721-3-1. Class 1C2 (chemical gases). Class 1S2 (solid particles)*
		Operation	IEC 60721-3-3. Class 3C2 (chemical gases). Class 3S2 (solid particles)*
		Transportation	IEC 60721-3-2. Class 2C2 (chemical gases) Class 2S2 (solid particles)*
		* C = chemically active substances S = mechanically active substances	

Dimensions

ACS580-01 IP21

Frames	Height		Width		Depth		Weight			
	H1* (mm)	in	H2** (mm)	in	mm	in	mm	in	kg	lb
R1	355	14.0	301	11.9	125	4.9	223	8.8	4.6	10.1
R2	449	17.7	394	15.5	125	4.9	229	8.9	7.5	16.6
R3	454	17.9	454	17.9	203	8.0	228	9	13.8	30.4
R4	600	23.6	600	23.6	203	8.0	258	10.2	19.0	41.9
R5	732	28.8	596	29.4	203	8.0	295	11.6	28.5	62.4
R6	727	28.8	549	28.6	252	9.9	369	14.5	45	99.2
R7	880	34.7	601	34.6	284	11.2	370	14.6	54	119.1
R8	965	38.0	677	38	300	11.8	393	15.5	69	152.2
R9	955	37.6	680	37.6	380	15.0	418	16.5	97	213.9

* Front height of the drive with glandbox

** Front height of the drive without glandbox

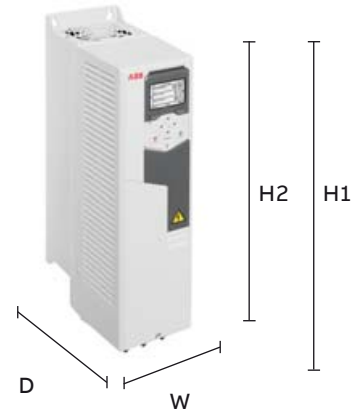

ACS580-01 IP55 (option +B056)

Frames	Height*		Width		Depth		Weight	
	mm	in	mm	in	mm	in	kg	lb
R1	387	15.2	125	4.9	233	9.2	5.1	11.3
R2	481	18.9	125	4.9	239	9.4	6.7	14.8
R3	456	18.0	206	8.1	237	9.3	13.0	28.7
R4	600	23.6	203	8.0	265	10.2	20	44.1
R5	732	28.8	203	8.0	320	12.6	29	64.0
R6	726	28.6	252	9.9	380	15.0	43	94.8
R7	880	34.6	284	11.2	381	15.0	56	123.5
R8	965	38.0	300	11.8	452	17.8	77	169.8
R9	955	37.6	380	15.0	477	18.78	103	227.1

* Front height of the drive with glandbox



ACS580-04 IP00

Frames	Height		Width		Depth		Weight	
	mm	in	mm	in	mm	in	kg	lb
R10	1462	57.55	350	13.78	529	20.81	162	357.15
R11	1662	63.43	350	13.78	529	20.81	200	440.93

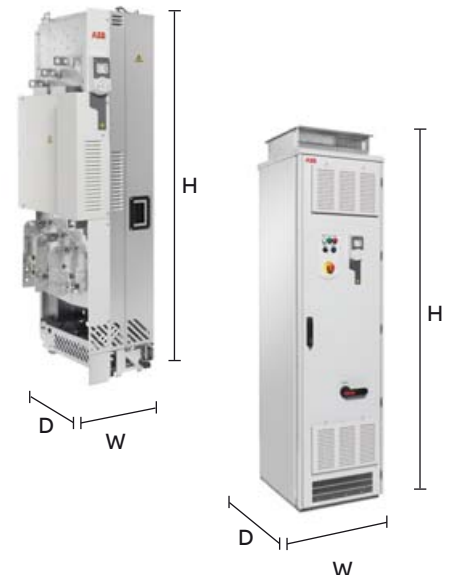

ACS580-07 IP21

Frames	Height		Width		Depth		Weight	
	mm	in	mm	in	mm	in	kg	lb
R6	2145	84.43	430	16.93	673	26.50	210	463
R7	2145	84.43	430	16.93	673	26.50	220	485
R8	2145	84.43	530	20.87	673	26.50	255	562
R9	2145	84.43	530	20.87	673	26.50	275	606
R10	2145	84.43	830	32.68	698	27.48	535	1179
R11	2145	84.43	830	32.68	698	27.48	581	1280

Ratings, types and voltages

Wall-mounted drives, ACS580-01														
3-phase, $U_N = 380, 400, 415$ V										3-phase, $U_N = 440, 460, 480$ V				
Nominal ratings				Max. output current	Light overload use		Heavy-duty use		Max. output current	Light overload use		Heavy-duty use		
		P_N (kW)	I_N (A)	I_{max} (A)	P_{Ld} (kW)	I_{Ld} (A)	P_{Hd} (kW)	I_{Hd} (A)	I_{max} (A)	I_{Ld} (A)	P_{Ld} (hp)	I_{Hd} (A)	P_{Hd} (hp)	
ACS580-01-02A7-4	R1	0.75	2.6	3.2	0.75	2.5	0.55	1.8	2.9	2.1	1	1.6	0.75	
ACS580-01-03A4-4	R1	1.1	3.3	4.7	1.1	3.1	0.75	2.6	3.8	3	1.5	2.1	1	
ACS580-01-04A1-4	R1	1.5	4	5.9	1.5	3.8	1.1	3.3	5.4	3.4	2	3	1.5	
ACS580-01-05A7-4	R1	2.2	5.6	7.2	2.2	5.3	1.5	4	6.1	4.8	3	3.4	2	
ACS580-01-07A3-4	R1	3	7.2	10.1	3	6.8	2.2	5.6	7.2	6	3	4	3	
ACS580-01-09A5-4	R1	4	9.4	13	4	8.9	3	7.2	8.6	7.6	5	4.8	3	
ACS580-01-12A7-4	R1	5.5	12.6	14.1	5.5	12	4	9.4	11.4	11	7.5	7.6	5	
ACS580-01-018A-4	R2	7.5	17	22.7	7.5	16.2	5.5	12.6	19.8	14	10	11	7.5	
ACS580-01-026A-4	R2	11	25	30.6	11	23.8	7.5	17	25.2	21	15	14	10	
ACS580-01-033A-4	R3	15	32	44.3	15	30.4	11	24.6	37.8	27	20	21	15	
ACS580-01-039A-4	R3	18.5	38	56.9	18.5	36.1	15	31.6	48.6	34	25	27	20	
ACS580-01-046A-4	R3	22	45	67.9	22	42.8	18.5	37.7	61.2	40	30	34	25	
ACS580-01-062A-4	R4	30	62	76	30	58	22	44.6	76	52	40	40	30	
ACS580-01-073A-4	R4	37	73	104	37	68.4	30	61	104	65	50	52	40	
ACS580-01-088A-4	R5	45	88	122	45	82.7	37	72	122	77	60	65	50	
ACS580-01-106A-4	R5	55	106	148	55	100	45	87	148	96	75	77	60	
ACS580-01-145A-4	R6	75	145	178	75	138	55	105	178	124	100	96	75	
ACS580-01-169A-4	R7	90	169	247	90	161	75	145	247	156	125	124	100	
ACS580-01-206A-4	R7	110	206	287	110	196	90	169	287	180	150	156	125	
ACS580-01-246A-4	R8	132	246	350	132	234	110	206	350	240	200	180	150	
ACS580-01-293A-4	R8	160	293	418	160	278	132	246*	418	260	200	240	150	
ACS580-01-363A-4	R9	200	363	498	200	345	160	293	542	361	300	302	250	
ACS580-01-430A-4	R9	250	430	617	200	400	200	363**	542	414	350	361	300	

Nominal ratings

I_N Rated current available continuously without overloadability at 40 °C.

P_N Typical motor power in no-overload use.

Maximum output current

I_{max} Maximum output current. Available for 2 seconds at start, then as long as allowed by drive temperature.

Light-overload use

I_{Ld} Continuous current allowing 110% I_{Ld} for 1 minute every 10 minutes at 40 °C.

P_{Ld} Typical motor power in light-overload use.

Heavy-duty use

I_{Hd} Continuous current allowing 150% I_{Hd} for 1 minute every 10 minutes at 40 °C.

* Continuous current allowing 130% I_{Hd} for 1 minute every 10 minutes at 40 °C.

** Continuous current allowing 125% I_{Hd} for 1 minute every 10 minutes at 40 °C.

P_{Hd} Typical motor power in heavy-duty use.

The ratings apply for the frames R1 to R9 up to +40 °C in enclosure class 21.

The ratings apply for the frames R10 to R11 up to +40 °C in enclosure class IP00/IP20.

For derating at higher altitudes, temperatures, switching frequencies or enclosure classes, see the HW manuals, document codes:

3AXD50000018826 and 3AXD50000015497.

Drive modules, ACS580-04

		3-phase, $U_N = 380, 400, 415\text{ V}$							3-phase, $U_N = 440, 460, 480\text{ V}$				
		Nominal ratings		Max. output current	Light overload use		Heavy-duty use		Max. output current	Light overload use		Heavy-duty use	
		P_N (kW)	I_N (A)	I_{max} (A)	P_{Ld} (kW)	I_{Ld} (A)	P_{Hd} (kW)	I_{Hd} (A)	I_{max} (A)	I_{Ld} (A)	P_{Ld} (hp)	I_{Hd} (A)	P_{Hd} (hp)
ACS580-04-505A-4	R10	250	505	560	250	485	200	361	560	483	400	361	300
ACS580-04-585A-4	R10	315	585	730	315	575	250	429	730	573	450	414	350
ACS580-04-650A-4	R10	355	650	730	355	634	250	477	730	623	500	477	400
ACS580-04-725A-4	R11	400	725	1020	400	715	315	566	850	705	600	566	450
ACS580-04-820A-4	R11	450	820	1020	450	810	355	625	1020	807	700	625	500
ACS580-04-880A-4	R11	500	880	1100	500	865	400	725*	1020	807	700	625	500

Cabinet-built drives, ACS580-07

		3-phase, $U_N = 380, 400, 415\text{ V}$							3-phase, $U_N = 440, 460, 480\text{ V}$				
		Nominal ratings		Max. output current	Light overload use		Heavy-duty use		Max. output current	Light overload use		Heavy-duty use	
		P_N (kW)	I_N (A)	I_{max} (A)	P_{Ld} (kW)	I_{Ld} (A)	P_{Hd} (kW)	I_{Hd} (A)	I_{max} (A)	I_{Ld} (A)	P_{Ld} (hp)	I_{Hd} (A)	P_{Hd} (hp)
ACS580-07-145A-4	R6	75	145	178	75	138	55	105	178	124	100	96	75
ACS580-07-169A-4	R7	90	169	247	90	161	75	145	247	156	125	124	100
ACS580-07-206A-4	R7	110	206	287	110	196	90	169	287	180	150	156	125
ACS580-07-246A-4	R8	132	246	350	132	234	110	206	350	240	200	180	150
ACS580-07-293A-4	R8	160	293	418	160	278	132	246**	418	260	200	240	150
ACS580-07-363A-4	R9	200	363	498	200	345	160	293	542	361	300	302	250
ACS580-07-430A-4	R9	250	430	617	200	400	200	363***	542	414	350	361	300
ACS580-07-495A-4	R10	250	495	560	250	485	200	361	560	483	400	361	300
ACS580-07-575A-4	R10	315	575	730	315	575	250	429	730	573	450	414	350
ACS580-07-640A-4	R10	355	640	730	355	634	250	477	730	623	500	477	400
ACS580-07-715A-4	R11	400	715	1020	400	715	315	566	850	705	600	566	450
ACS580-07-810A-4	R11	450	810	1020	450	810	355	625	1020	807	700	625	500
ACS580-07-870A-4	R11	500	870	1100	500	865	400	725*	1020	807	700	625	500

Nominal ratings

I_N	Rated current available continuously without overloadability at 40 °C.
P_N	Typical motor power in no-overload use.

Maximum output current

I_{max}	Maximum output current. Available for 2 seconds at start, then as long as allowed by drive temperature.
-----------	---

Light-overload use

I_{Ld}	Continuous current allowing 110% I_{Ld} for 1 minute every 10 minutes at 40 °C.
P_{Ld}	Typical motor power in light-overload use.

Heavy-duty use

I_{Hd}	Continuous current allowing 150% I_{Ld} for 1 minute every 10 minutes at 40 °C. * Continuous current allowing 140% I_{Hd} for 1 minute every 10 minutes at 40 °C ** Continuous current allowing 130% I_{Hd} for 1 minute every 10 minutes at 40 °C. *** Continuous current allowing 125% I_{Hd} for 1 minute every 10 minutes at 40 °C.
P_{Hd}	Typical motor power in heavy-duty use.

The ratings apply for the frames R6 to R9 up to +40 °C in enclosed IP class 21.

The ratings apply for the frames R10 to R11 up to +40 °C in enclosed IP00/IP20.

For derating at higher altitudes, temperatures or switching frequencies, see the HW manuals, document codes: 3AXD50000018826, 3AXD50000015497, 3AXD50000045815 and 3AXD50000032622

Control panel options

—
01 Assistant control panel is included as standard.

—
02 Optional Bluetooth panel. USB connection as standard.

—
03 By using the CDPI-01 panel adapter, the assistant control panel is able to manage up to 32 drives.

Assistant control panel

Set up the drive using the assistant control panel delivered as standard with all ACS580 drives. There is no need to know any drive parameters, as the control panel helps to set up the essential settings quickly and get the drive into action.

- Drive setup with the primary settings menu including embedded assistants
- Process monitoring with one glance at the control panel's editable home view showing you the status of the drive and process
- Drive maintenance with the help function providing context-sensitive guidance and troubleshooting instructions
- Drive diagnostics under the diagnostics menu informing the user of the root cause.

Bluetooth panel

The optional Bluetooth panel enables connection with the Drivetune mobile app. The app is available for free on the Google Play and the Apple App store.

Some of the Drivetune features are: commissioning, troubleshooting, monitoring and controlling the drive. Drivetune also has full parameter access.



Control panel options

Assistant control panel ACS-AP-S is included as standard in the delivery. ACS-AP-S (+J400) can be replaced by +J options below.

Option code	Description	Type designation
+J400	Assistant control panel (+J400 option automatically included)	ACS-AP-S
+J425	Industrial Assistant control panel*	ACS-AP-I
+J429	Control panel with Bluetooth interface*	ACS-AP-W
+J404	Basic control panel	ACS-BP-S
+J424	Blank control panel cover (no control panel delivered)	CDUM-01
3AXD5000004419	Panel bus adapter	CDPI-01
3AUA0000108878	Control panel mounting platform (flush mounted, requires also panel bus adapter on the drive)	DPMP-01
3AXD50000009374	Control panel mounting platform (surface mounted, requires also panel bus adapter on the drive)	DPMP-02
3AXD50000016230	Control panel mounting platform option, only for ACS580-04 modules	DPMP-03
3AXD50000010763	Door mounting kit for the panel (for one drive, contains both DPMP-02 and CDPI-01)	DPMP-EXT

* Also compatible with ACS880 drives

Additional options

04 Cold configuration adapter CCA-01

05 Remote monitoring tool NETA-21

06 Drive composer PC tool

Safe configuration for unpowered drives

The CCA-01 cold configuration adapter provides a serial communication interface for unpowered ACS580 drives. With the adapter, safety isolation of both serial communication and control board power supply is possible. The power supply is taken from a PC USB port.



Remote monitoring access worldwide

The NETA-21 remote monitoring tool gives easy access to the drive via the Internet or local Ethernet network. NETA-21 comes with a built-in web server. Compatible with standard web browsers, it ensures easy access to a web-based user interface. Through the web interface, the user can configure drive parameters, and monitor drive log data, load levels, runtime, energy consumption, I/O data and bearing temperatures of the motor connected to the drive.

PC tools

The Drive composer PC tool offers fast and harmonized setup, commissioning and monitoring for all-compatible drives. The free version of the tool provides startup and maintenance capabilities and gathers all drive information, such as parameter loggers, faults, backups and lists, into a support diagnostics file. Drive composer pro provides additional features such as custom parameter windows, graphical control diagrams of the drive's configuration, and improved monitoring and diagnostics.

Ordering code	Description	Type designation
3AXD50000019865	Cold configurator adapter, packed kit	CCA-01

Remote monitoring option

Ordering code	Description	Type designation
3AUA0000094517	2 x panel bus interface 2 x 32 = max. 64 drives 2 x Ethernet interface SD memory card USB port for WLAN/3G	NETA-21

Connectivity options

—
07 ACS580 is
compatible with many
fieldbus protocols

—
08 Input/output
extension modules

Fieldbus adapter modules

The ACS580 general purpose drives are compatible with a wide range of fieldbus protocols. The drive comes with Modbus RTU fieldbus interface as standard. Fieldbus communication reduces wiring costs when compared to traditional hardwired input/output connections.



—
07

Fieldbus adapters

Option code	Fieldbus protocol	Adapter
+K451	DeviceNet™	FDNA-01
+K454	PROFIBUS DP, DPV0/DPV1	FPBA-01
+K457	CANopen®	FCAN-01
+K458	Modbus RTU	FSCA-01
+K462	ControlNet	FCNA-01
+K469	EtherCAT®	FECA-01
+K470	POWERLINK	FEPL-02
+K473	EtherNet/IP™, Modbus TCP, PROFINET IO	FENA-11
+K475	Two port EtherNet/IP™, Modbus TCP, PROFINET IO	FENA-21

Input/output extension modules

Standard input and output can be extended by using optional analog and digital input/output extension modules. The modules are easily installed in the extension slots located on the drive.



—
08

I/O options

Option code	Description	Type designation
+L501	External 24 V AC and DC 2 x RO and 1 x DO	CMOD-01
+L523	External 24 V and isolated PTC interface	CMOD-02
+L512	115/230 V digital input 6 x DI and 2 x RO	CHDI-01
+L537	ATEX certified PTC interface and external 24V	CPTC-02

EMC – electromagnetic compatibility

Every ACS580 drive is equipped with a built-in filter to reduce high-frequency emissions. EMC product standard (EN 61800-3) category C2 is fulfilled in wall-mounted drives and in cabinet-built drives up to frame size R9. Category C3 is fulfilled in drive modules and cabinet-built drives (frames R10 and R11) with no external filters.

EMC standards

The EMC product standard (EN 61800-3) covers the specific EMC requirements stated for drives (tested with motor and motor cable) within the EU. EMC standards such as EN 55011 or EN 61000-6-3/4 are applicable to industrial and domestic equipment and systems, including the components inside the drive. Drive units complying with the requirements of EN 61800-3 are compliant with comparable categories in

EN 55011 and EN 61000-6-3/4 but not necessarily vice versa. EN 55011 and EN 61000-6-3/4 do not specify cable length or require a motor to be connected as a load. The emission limits are comparable to EMC standards according to the table below.

Domestic environments versus public low voltage networks

The first environment includes domestic premises. It also includes establishments directly connected without an intermediate transformer to a low voltage power supply network that supplies buildings used for domestic purposes. The second environment includes all establishments directly connected to public low voltage power supply networks.

Comparison of EMC standards

EMC according to EN 61800-3 product standard	EN 61800-3 product standard	EN 55011. product family standard for industrial, scientific and medical (ISM) equipment	EN 61000-6-4, generic emission standard for industrial environments	EN 61000-6-3, generic emission standard for residential, commercial and light-industrial environment
1 st environment, unrestricted distribution	Category C1	Group 1. Class B	Not applicable	Applicable
1 st environment, restricted distribution	Category C2	Group 1. Class A	Applicable	Not applicable
2 nd environment, unrestricted distribution	Category C3	Group 2. Class A	Not applicable	Not applicable
2 nd environment, restricted distribution	Category C4	Not applicable	Not applicable	Not applicable

EMC compliance and maximum cable length of ACS580-01/07 units*

Type	Voltage	Frame sizes	1 st environment, restricted distribution, C2, grounded network (TN)	2 nd environment, unrestricted distribution, C3, grounded network (TN)	2 nd environment, unrestricted distribution, C3, ungrounded network (IT)
ACS580-01	380 - 480 V	R1 - R5	Standard device, cable length 100 m	Standard device, cable length 100 m	-
ACS580-01/07	380 - 480 V	R6 - R9	Standard device, cable length 150 m	Standard device, cable length 150 m	-

* Motor cable operational functionality up to 300 m. See ACS580 hardware manuals 3AXD50000018826, 3AXD50000015497, 3AXD50000045815 and 3AXD50000032622 for frame specific information.

Cooling and fuses

Cooling

ACS580 drives are fitted with variable-speed cooling air fans. The cooling air must be free from corrosive materials and not exceed the maximum ambient temperature of 40 °C for frames R1 to R9 (50 °C with derating). The speed-controlled fans cool the drive only when needed, which reduces overall noise level and energy consumption.

Fuse connections

Standard fuses can be used with ABB general purpose drives. For input fuses, see the table below.

Wall-mounted drives, ACS580-01

Cooling air flow and recommended input protection fuses for 380 to 415 V units

Type designation	Frame size	Cooling air flow 380 to 415 V units					Recommended input protection fuses for 380 to 415 V units***				
		Heat dissipation*		Air flow		Max. noise level**	IEC fuses		UL fuses		
		W	BTU/Hr	m3/h	ft3/min		A	Fuse type	A	Fuse type	
ACS580-01-02A7-4	R1	45	155	34	20	56	4	gG	6	UL Class T	
ACS580-01-03A4-4	R1	55	187	34	20	56	6	gG	6	UL Class T	
ACS580-01-04A1-4	R1	66	224	34	20	56	6	gG	6	UL Class T	
ACS580-01-05A7-4	R1	84	288	34	20	56	10	gG	10	UL Class T	
ACS580-01-07A3-4	R1	106	362	50	29	55	10	gG	10	UL Class T	
ACS580-01-09A5-4	R1	133	454	50	29	55	16	gG	15	UL Class T	
ACS580-01-12A7-4	R1	174	593	50	29	55	16	gG	15	UL Class T	
ACS580-01-018A-4	R2	228	777	128	75	66	25	gG	20	UL Class T	
ACS580-01-026A-4	R2	322	1100	128	75	66	32	gG	30	UL Class T	
ACS580-01-033A-4	R3	430	1469	116	68	71	40	gG	35	UL Class T	
ACS580-01-039A-4	R3	525	1791	116	68	71	50	gG	45	UL Class T	
ACS580-01-046A-4	R3	619	2114	116	68	71	63	gG	50	UL Class T	
ACS580-01-062A-4	R4	1153	3938	280	165	69	80	gG	80	UL Class T	
ACS580-01-073A-4	R4	1153	3938	280	165	69	100	gG	90	UL Class T	
ACS580-01-088A-4	R5	1156	3948	280	165	62	100	gG	110	UL Class T	
ACS580-01-106A-4	R5	1331	4546	435	256	67	125	gG	150	UL Class T	
ACS580-01-145A-4	R6	1476	5041	435	256	67	160	gG	200	UL Class T	
ACS580-01-169A-4	R7	1976	6748	450	265	67	250	gG	225	UL Class T	
ACS580-01-206A-4	R7	2346	8012	550	324	67	315	gG	300	UL Class T	
ACS580-01-246A-4	R8	3336	11393	550	324	65	355	gG	350	UL Class T	
ACS580-01-293A-4	R8	3936	13442	1150	677	65	425	gG	400	UL Class T	
ACS580-01-363A-4	R9	4836	16516	1150	677	68	500	gG	500	UL Class T	
ACS580-01-430A-4	R9	6036	20614	1150	677	68	700	gG	600	UL Class T	

* Heat dissipation value is a reference for cabinet thermal design.

** The maximum noise level at full fan speed. When the drive is not operating at full load and at maximum ambient temperature the noise level is lower.

*** For detailed fuse sizes and types, please see the ACS580 HW manuals. document codes: 3AXD50000018826 and 3AXD50000015497.

Drive modules, ACS580-04

Cooling air flow and recommended input protection fuses for 380 to 415 V units

Type designation	Frame size	Cooling air flow 380 to 415 V units					Recommended input protection fuses for 380 to 415 V units***			
		Heat dissipation*		Air flow		Max. noise level**	IEC fuses		UL fuses	
		W	BTU/Hr	m3/h	ft3/min	dBA	A	Fuse type	A	Fuse type
ACS580-04-505A-4	R10	5600	19132	1200	707	72	***	***	***	***
ACS580-04-585A-4	R10	6400	21888	1200	707	72	***	***	***	***
ACS580-04-650A-4	R10	8100	27738	1200	707	72	***	***	***	***
ACS580-04-725A-4	R11	8700	29931	1200	707	72	***	***	***	***
ACS580-04-820A-4	R11	9800	33680	1200	707	72	***	***	***	***
ACS580-04-880A-4	R11	10500	36126	1420	848	72	***	***	***	***

* Heat dissipation value is a reference for cabinet thermal design.

** The maximum noise level at full fan speed. When the drive is not operating at full load and at maximum ambient temperature the noise level is lower.

*** For detailed fuse sizes and types, please see the ACS580 HW manuals, document codes: 3AXD50000018826 and 3AXD50000015497.

Cabinet-built drives, ACS580-07

Cooling air flow and recommended input protection fuses for 380 to 415 V units

Type designation	Frame size	Cooling air flow 380 to 415 V units					Recommended input protection fuses for 380 to 415 V units***			
		Heat dissipation*		Air flow		Max. noise level**	IEC fuses		UL fuses	
		W	BTU/Hr	m3/h	ft3/min	dBA	A	Fuse type	A	Fuse type
ACS580-07-0145A-4	R6	1827	1801	685	982	67	250	170M3816D	250	DFJ-250
ACS580-07-0169A-4	R7	2335	2317	700	1004	67	250	170M3816D	300	DFJ-300
ACS580-07-0206A-4	R7	2738	2716	700	1004	67	315	170M3817D	300	DFJ-300
ACS580-07-0246A-4	R8	3719	3719	800	1147	65	400	170M5408	400	170M5408
ACS580-07-0293A-4	R8	4352	4352	800	1147	65	500	170M5410	500	170M5410
ACS580-07-0363A-4	R9	5321	5314	1400	2007	68	630	170M6410	630	170M6410
ACS580-07-0430A-4	R9	6589	6579	1400	2007	68	700	170M6411	700	170M6411
ACS580-07-495A-4	R10	5602	19132	2950	1837	72	800	170M6412	***	***
ACS580-07-575A-4	R10	6409	21888	2950	1837	72	900	170M6413	***	***
ACS580-07-640A-4	R10	8122	27738	2950	1837	72	1000	170M6414	***	***
ACS580-07-715A-4	R11	8764	29931	2950	1837	72	1250	170M6416	***	***
ACS580-07-810A-4	R11	9862	33680	2950	1837	72	1250	170M6416	***	***
ACS580-07-870A-4	R11	10578	36126	3170	1978	72	1400	170M6417	***	***

* Heat dissipation value is a reference for cabinet thermal design.

** The maximum noise level at full fan speed. When the drive is not operating at full load and at maximum ambient temperature the noise level is lower.

*** For detailed fuse sizes and types, please see the ACS580 HW manuals, document codes: 3AXD50000018826, 3AXD50000015497, 3AXD50000045815 and 3AXD50000032622.

du/dt filters

du/dt filtering suppresses inverter output voltage spikes and rapid voltage changes that stress motor insulation. Additionally, du/dt filtering reduces capacitive leakage currents and high-frequency emissions from the motor cable as well as high-frequency losses and bearing currents in

the motor. The need for du/dt filtering depends on the motor insulation. For information on the construction of the motor insulation, consult the manufacturer. More information on the du/dt filters can be found in the ACS580 hardware manual.

External du/dt filter for ACS580-01 and ACS580-04		du/dt filter type * 3 filters included, dimensions apply to one filter.																
		Unprotected (IP00)				Protected to IP22			Protected to IP54									
		NOCH0016-60	NOCH0030-60	NOCH0070-60	NOCH0120-60*	FOCH0260-70	FOCH0320-50	FOCH0610-70	FOCH0875-70	NOCH0016-62	NOCH0030-62	NOCH0070-62	NOCH0120-62	NOCH0016-65	NOCH0030-65	NOCH0070-65	NOCH0120-65	BOCH-0880A-7
ACS580																		
400 V																		
ACS580-01-02A7-4	x									x				x				
ACS580-01-03A4-4	x									x				x				
ACS580-01-04A1-4	x									x				x				
ACS580-01-05A7-4	x									x				x				
ACS580-01-07A3-4	x									x				x				
ACS580-01-09A5-4	x									x				x				
ACS580-01-12A7-4	x									x				x				
ACS580-01-018A-4	x	x								x				x				
ACS580-01-026A-4	x	x								x				x				
ACS580-01-033A-4	x		x								x				x			
ACS580-01-039A-4	x		x								x				x			
ACS580-01-046A-4	x		x								x				x			
ACS580-01-062A-4	x		x								x				x			
ACS580-01-073A-4				x								x					x	
ACS580-01-088A-4				x								x					x	
ACS580-01-106A-4				x								x					x	
ACS580-01-145A-4					x													
ACS580-01-169A-4					x													
ACS580-01-206A-4					x													
ACS580-01-246A-4					x													
ACS580-01-293A-4					x													
ACS580-01-363A-4						x												
ACS580-01-430A-4						x												
ACS580-04-505A-4							x											
ACS580-04-585A-4							x											
ACS580-04-650A-4							x											
ACS580-04-725A-4								x										
ACS580-04-820A-4								x										
ACS580-04-880A-4								x										

External du/dt filters for ACS580-07				du/dt filter type * 3 filters included, dimensions apply to one filter.		
				Protected to IP54		
				BOCH-0880A-7	COF-01	COF-02
ACS580						
400 V						
ACS580-07-0145A-4					x	
ACS580-07-0169A-4					x	
ACS580-07-0206A-4					x	
ACS580-07-0246A-4						x
ACS580-07-0293A-4						x
ACS580-07-0363A-4						x
ACS580-07-0430A-4						x
ACS580-07-0495A-4	x					
ACS580-07-0575A-4	x					
ACS580-07-0640A-4	x					
ACS580-07-0715A-4	x					
ACS580-07-0810A-4	x					

Dimensions and weights of the du/dt filters				
du/dt filter	Height (mm)	Width (mm)	Depth (mm)	Weight (kg)
NOCH0016-60	195	140	115	2.4
NOCH0016-62/65	323	199	154	6
NOCH0030-60	215	165	130	4.7
NOCH0030-62/65	348	249	172	9
NOCH0070-60	261	180	150	9.5
NOCH0070-62/65	433	279	202	15.5
NOCH0120-60 ³⁾	200	154	106	7
NOCH0120-62/65	765	308	256	45
FOCH0260-70	382	340	254	47
FOCH0320-50	662	319	293	65
FOCH0610-70	662	319	293	65
FOCH0875-70	662	319	293	65
BOCH-0880A-7	400	248	456	18
COF-01	570	296	360	23
COF-02	570	360	301	23



ABB automation products



AC500

ABB's powerful flagship PLC offering provides wide range of performance levels and scalability within a single simple concept where most competitors require multiple product ranges to deliver similar functionality.



AC500-S

A PLC based modular automation solution that makes it easier than before to mix and match standard and safety I/O modules to expertly meet your safety requirements in all functional safety applications. "Extreme conditions" version is also offered.



Programmability

Automation Builder integrates the engineering and maintenance for PLC, drives, motion, HMI and robotics. It complies with the IEC 61131-3 standard offering all five IEC programming languages for PLC and drive configuration. Automation Builder supports a number of languages and comes with new libraries, FTP functions, SMTP, SNTP, smart diagnostics and debugging capabilities.



AC motors

ABB's low voltage AC motors are designed to save energy, reduce operating costs and enable demanding motor applications to perform reliably and without unscheduled downtime. General performance motors combine convenience and easy handling seamlessly with ABB's engineering expertise. Process performance motors provide the most comprehensive, versatile set of motors for the process industries and heavy-duty applications.



AC500-eCo

Meets the cost-effective demands of the small PLC market while offering total inter-operability with the core AC500 range. Web server, FTP server and Modbus-TCP for all Ethernet versions. A Pulse Train output module is available for multi-axis positioning.

AC500-XC

"Extreme conditions" modules with extended operating temperature, immunity to vibration and hazardous gases, for use at high altitudes, in humid conditions, etc. It replaces expensive cabinets with its built-in protection.



Control panels

Our control panels offer a wide range of touchscreen graphical displays from 3.5" up to 15". They are provided with user-friendly configuration software that enables tailor made customized HMI solutions. Rich sets of graphical symbols and the relevant drivers for ABB automation products are provided. Control panels for visualization of AC500 web server PLC applications are available.



All-compatible drives portfolio

The all-compatible drives share the same architecture; software platform, tools, user interfaces and options. Yet, there is an optimal drive from the smallest water pump to the biggest cement kiln, and everything in the between. When you have learned to use one drive it is easy use the other drives in the portfolio.



Jokab safety products

ABB Jokab Safety offers an extensive range of innovative products and solutions for machine safety systems. It is represented in standardization organizations for machine safety and works daily with the practical application of safety requirements in combination with production requirements.



Save time, ease troubleshooting and improve drive performance with ABB smartphone apps

Better connectivity and user experience with Drivetune

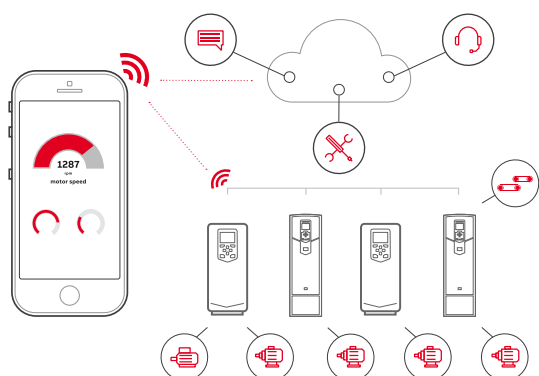

Easy and fast access to product information and support

Manage your drives and the process lines and machines they control



Easy access to cloud-based drive and process information from anywhere via an online connection



Start up, commission and tune your drive and application



Simplified user guidance with instant access to drive status and configuration



Performance optimization via drive troubleshooting features and fast support

Services and support on the go with Drivebase

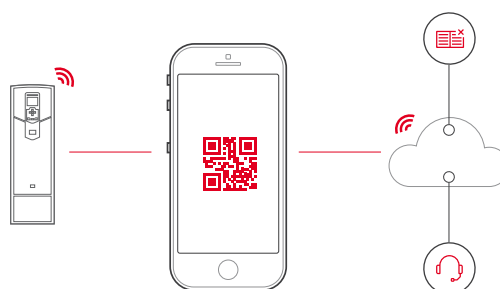

Search for support documents and contacts

Maintain and service all your installed drives on one or multiple sites



Get 6 months extra warranty for free by registering your drive with the Drivebase app



Access your product and service information in the cloud from anywhere



Access your drive's diagnostics data



Push notifications for critical product and service updates

Access information anywhere

Download the apps using the QR codes below or directly from the app stores



Drivetune for commissioning and managing drives



Drivebase for ensured reliability and reduced downtime on production sites

Services to match your needs

Your service needs depend on your operation, life cycle of your equipment and business priorities. We have identified our customers' four most common needs and defined service options to satisfy them. What is your choice to keep your drives at peak performance?

Operational efficiency



Is uptime your priority?

Keep your drives running with precisely planned and executed maintenance.

Example services include:

- Life Cycle Assessment
- Installation and Commissioning
- Spare Parts
- Preventive Maintenance
- Reconditioning
- ABB Drive Care agreement
- Drive Exchange

Rapid response



Is rapid response a key consideration?

If your drives require immediate action, our global network is at your service.

Example services include:

- Technical Support
- On-site Repair
- Remote Support
- Response time agreements
- Training

Drives service

Your choice, your future

The future of your drives depends on the service you choose.

Whatever you choose, it should be a well-informed decision. No guesswork. We have the expertise and experience to help you find and implement the right service for your drive equipment. You can start by asking yourself these two critical questions:

- Why should my drive be serviced?
- What would my optimal service options be?

From here, you have our guidance and full support along the course you take, throughout the entire lifetime of your drives.

Your choice, your business efficiency

ABB Drive Care agreement lets you focus on your core business. A selection of predefined service options matching your needs provides optimal, more reliable performance, extended drive lifetime and improved cost control. So you can reduce the risk of unplanned downtime and find it easier to budget for maintenance.

We can help you more by knowing where you are!

Register your drive at www.abb.com/drivereg for extended warranty options and other benefits.

Life cycle management



Need to extend your assets' lifetime?

Maximize your drive's lifetime with our services.

Example services include:

- Life Cycle Assessment
- Upgrades, Retrofits and Modernization
- Replacement, Disposal and Recycling

Performance improvement



Is performance most critical to your operation?

Get optimal performance out of your machinery and systems.

Example services include:

- Advanced services
- Engineering and Consulting
- Inspection and Diagnostics
- Upgrades, Retrofits and Modernization
- Workshop Repair
- Tailored services

A lifetime of peak performance

You're in control of every life cycle phase of your drives. At the heart of drive services is a four-phase product life cycle management model. This model defines the services recommended and available throughout drives lifespan.

Now it's easy for you to see the exact service and maintenance available for your drives.

ABB drives life cycle phases explained:

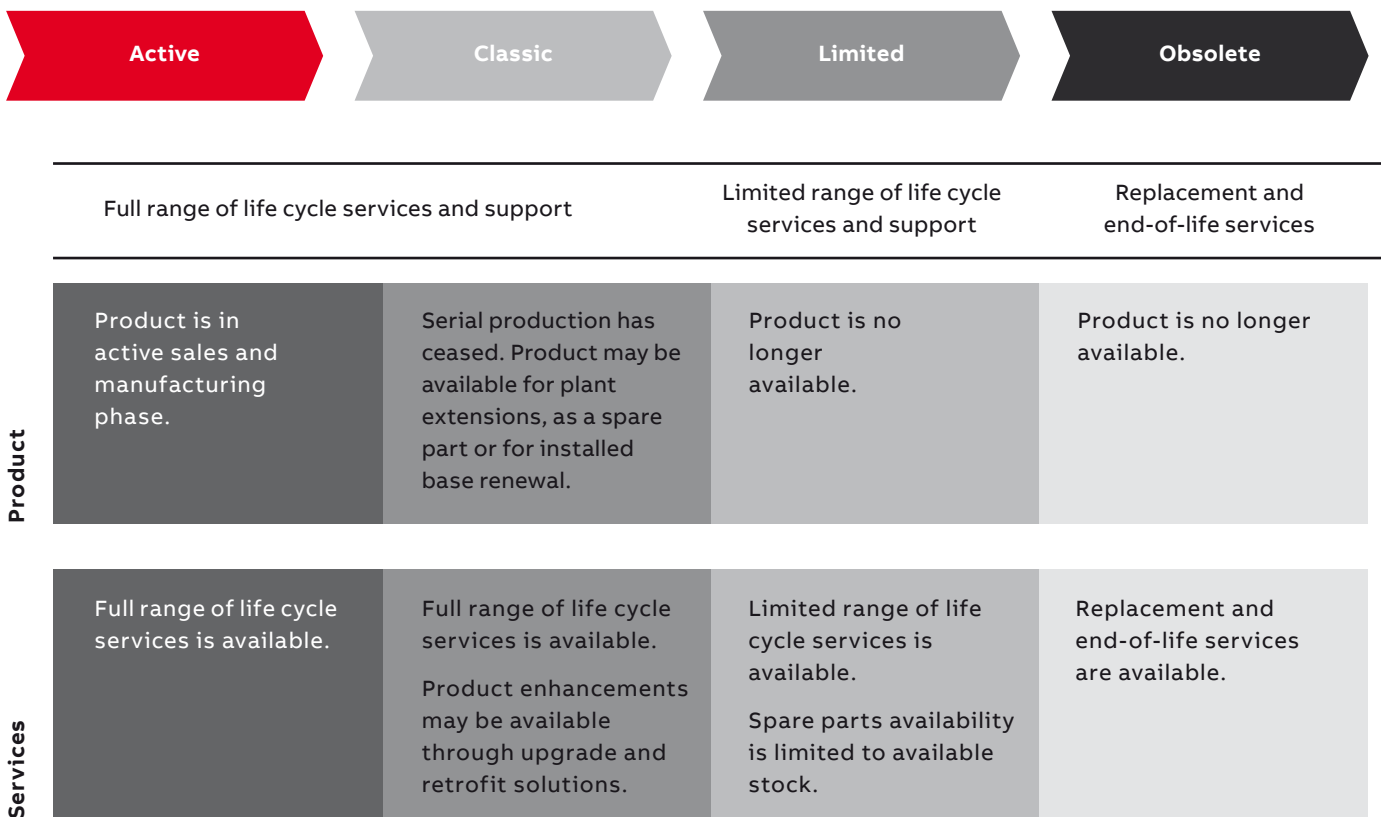

Keeping you informed

We notify you every step of the way using life cycle status statements and announcements.

Your benefit is clear information about your drives' status and precise services available. It helps you plan the preferred service actions ahead of time and make sure that continuous support is always available.

Step 1

Life Cycle Status Announcement

Provides early information about the upcoming life cycle phase change and how it affects the availability of services.

Step 2

Life Cycle Status Statement

Provides information about the drive's current life cycle status, availability of product and services, life cycle plan and recommended actions.



ABB

Place a barcode inside the viewfinder rectangle to scan it.

Cancel

Stop

Loc/Rem

Start



—
For more information, please contact
your local ABB representative or visit

www.abb.com/ACS580
www.abb.com/drives
www.abb.com/drivespartners
www.abb.com/motors&generators

Online manuals
for the ACS580 drives



Video playlist:
ACS580 how-to videos

