



YASKAWA

# YASKAWA AC Drive Compact Vector Control Drive V1000

200 V CLASS, THREE-PHASE INPUT: 0.1 to 18.5 kW  
200 V CLASS, SINGLE-PHASE INPUT: 0.1 to 3.7 kW  
400 V CLASS, THREE-PHASE INPUT: 0.2 to 18.5 kW



So advanced !

So easy !

So small !

Certified for  
ISO9001 and  
ISO14001



JQA-0422



JQA-EM0498



# Bringing you the world's smallest variable speed drive to stand at the top of its class: V1000

Yaskawa has built a reputation for high performance, functionality, quality, and reliability. To make it even easier to optimize your applications, we present the new V1000.

A single drive with so many uses, benefiting your application the more you use it.

## So advanced!

\*: Results from market research on vector drives performed by Yaskawa.

Quick and easy installation, ready to run your application in no time. You'll be amazed how simple it is to use.

# So easy!



# Smallest in the world!

Top performance for its class. Loaded with functions and features in an unbelievably small package!



RoHS compliant

C O N T E N T S

Features	4
Advantages for Each Application	8
Software Functions	10
Operation Instructions	12
Product System	14
Model Selection	15
Standard Specifications	16
Standard Connection Diagram	18
Dimensions	20
Peripheral Devices and Options	22
Application Notes	24
Service Network	29



PUMP



FAN



HVAC

FLUID MACHINE ▶ See page 8.

APPLICATIONS

COMPACT CONVEYOR ▶ See page 9.



CONVEYOR



PACKAGING



AUTO SHUTTER

Even more eye-opening versatility.

V1000

## Features

Yaskawa offers solutions customized for your application in an incredibly compact, technologically advanced, environmentally responsible package capable of driving a synchronous motor.

# So advanced!

## Sensorless Control of PM Motors Capability

### Two drives in one

V1000 runs not only induction motors, but synchronous motors like IPMM and SPMM motors as well. Get a single drive for all your application needs, and save on spare parts.

Note: See product specifications for information on motor precision.  
The variable torque ratio of synchronous motors is 1 to 10.

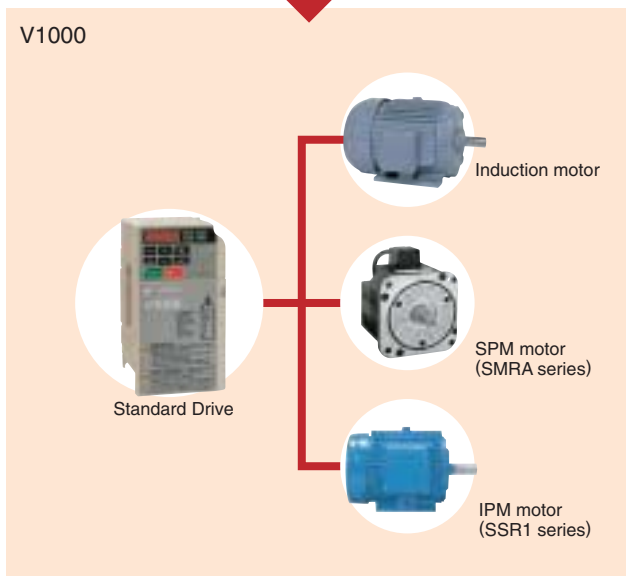
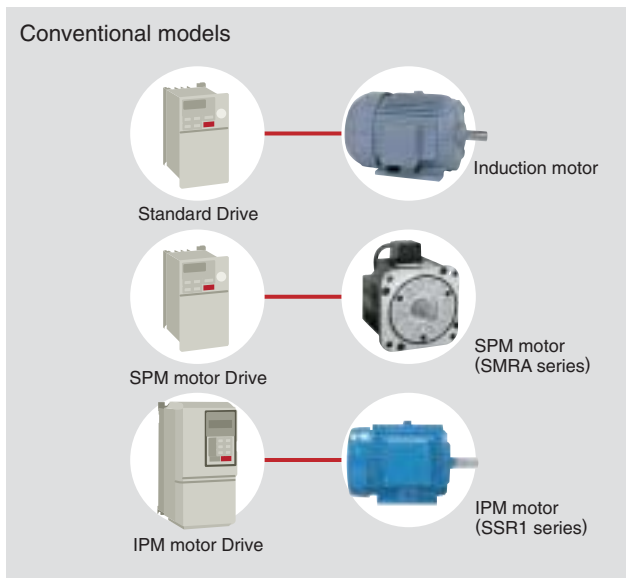

## Top of Its Class

### Impressive Torque Characteristics

V1000 is the first in its class fully equipped with current vector control. Current Vector control providing a powerful starting torque of 200%\* at 0.5 Hz and precise torque limit operations. The motor Auto-Tuning function saves valuable start up time and assures high performance operation at the highest efficiency.

\*: Using a Yaskawa induction motor under 3.7 kW set for Heavy Duty torque performance.

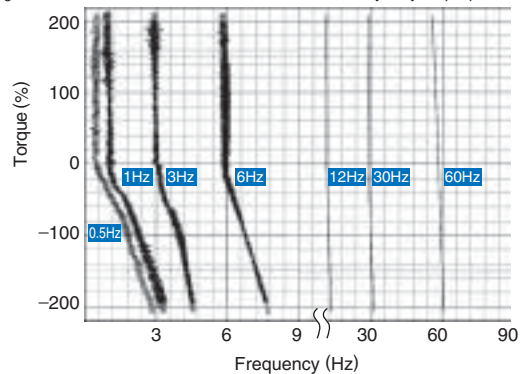

### Increased braking power during deceleration.

Faster deceleration time with overexcitation braking.

\*: Example shown is for a 400 V 3.7 kW drive without braking resistor. Circumstances depends on the motor and load.

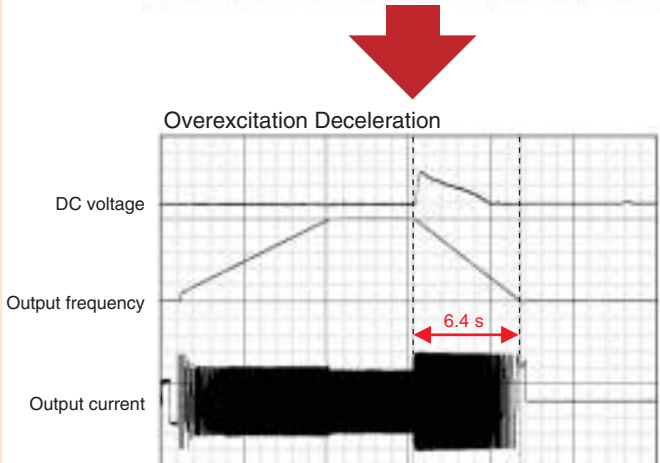
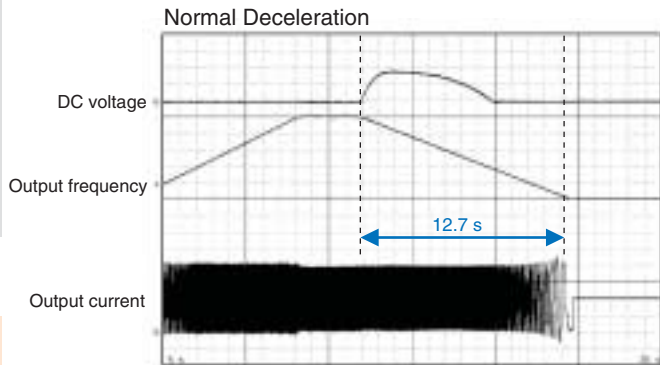

**50% faster!**

simplest, smallest drive of its class.

### No more trouble from power loss.

V1000 is fully equipped with speed search and KEB Ride-Thru functions for your application needs, whether running an induction motor or permanent magnet motor.

#### ●Speed Search Method

Easily restart the motor without cumbersome speed sensors. Perfect for fan, blowers, and other rotating, fluid-type applications.

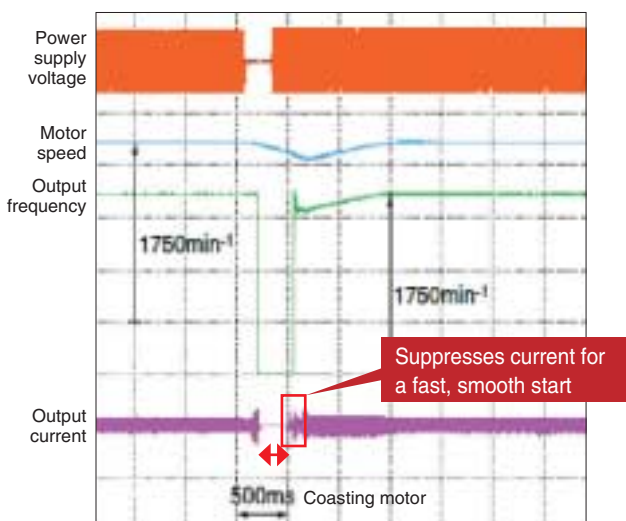

Speed Search performs smooth restart by finding the coasting motors speed.

#### ●KEB Ride-Thru

Drive continues operation by using motor regen. Perfect for HVAC

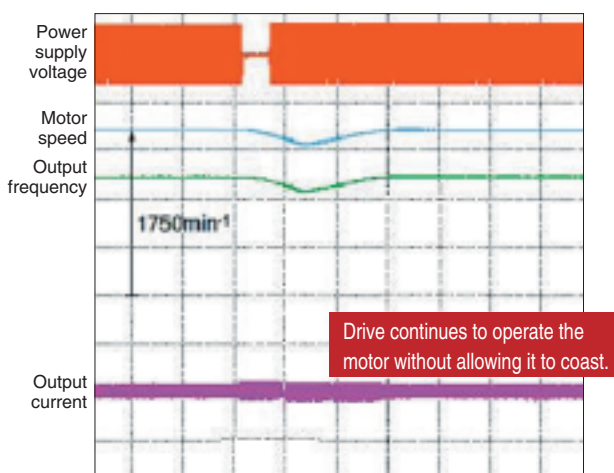

Note: Requires a sensor to detect when power loss occurs. Load conditions may still trip a fault and cause the motor to coast.

### Customize the Drive

#### Build your Drive!

Optional visual programming software lets you instantly customize V1000 to your application. Let the drive do external device or PLC functions! Easy Drag and Drop functions starting from simple timers up to complex application blocks let you create your very own drive.

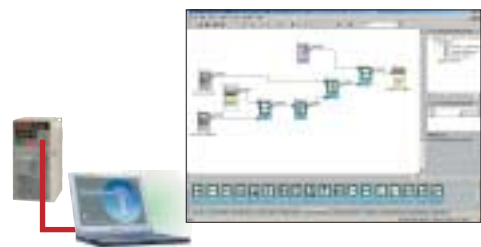

### So much variation possible

#### Global Networking

The built in high speed RS-422/485 Memobus and a variety of option cards connect V1000 to all popular fieldbus networks. The optional 24 VDC power supply keeps the drive controller alive under all conditions, providing network communications and monitoring functions even during a main power loss.

Open Field Network	CC-Link
	DeviceNet*
	PROFIBUS-DP
	CANopen*
	LONWORKS*

\* : For release soon.  
DeviceNet is a trademark of ODVA.  
LONWORKS is a trademark of Echelon.

#### Specialized Types

Single-unit filter, finless design, and dust-proof models also available.



\*: For release soon.

### Environmentally Friendly

#### Protecting Against Harsh Environments

Various products are available to protect your drive against humidity, dust, oil mist, and vibration. Contact Yaskawa for more information.

#### RoHS Compliance

All V1000 models are fully compliant with the RoHS initiative.

## Features

From setup to maintenance, V1000 makes life easy.

# So easy!

Parameters set automatically—hassle free programming!

### Start up instantly with application presets!

V1000 automatically sets the parameters needed for various applications. Presets for water supply pumps, conveyor systems, exhaust fans, and other applications program the drive instantly for optimized performance—saving enormous hassle setting up for a test run.



Setting	Application Preset
01	Water Supply Pump
02	Conveyor
03	Exhaust Fan
04	HVAC Fan
05	Air Compressor
06	Crane (Hoist)
07	Crane (Travel)

Parameters are programmed automatically:	
b1-01	Frequency Reference Selection 1
b1-02	Run Command Selection 1
C1-01	Acceleration Time 1
C1-02	Deceleration Time 1
⋮	⋮

## Breeze-Easy Setup

### Install Multiple Drive Immediately with the USB Copy Unit

Get several drives up and running easily using the USB copy unit. The same copy unit is fully PC compatible.

### Hassle free setting and maintenance straight from a PC

Drive Wizard lets you manage the unique settings for all your drives right on your PC.

With DriveWizard's preset operation sequences, built-in oscilloscope function, fine tuning the drive and maintenance checks have never been easier.



#### ● Sequence Operation

V1000 automatically follows your preset operation pattern.



#### ● Oscilloscope Function

Displays operation status and drive performance in real time.



## Safety Standard Compliance

V1000 is the first drive in its class to come standard with safety input features compliant with EN954-1, safety category 3, IEC/EN61508 SIL2.

By being able to perform an EN60204-1, stop category 0 conform safe stop, V1000 reduces the number of peripheral devices needed to satisfy the safety regulations.

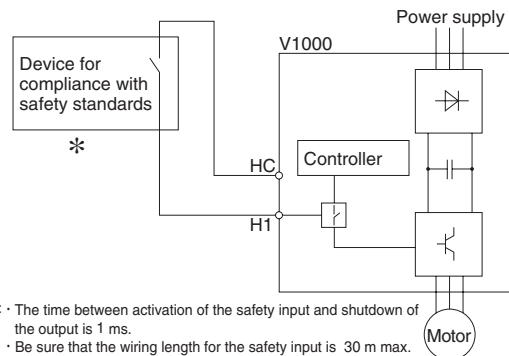

\*: · The time between activation of the safety input and shutdown of the output is 1 ms.  
· Be sure that the wiring length for the safety input is 30 m max.

Application Example: Safety Compliance

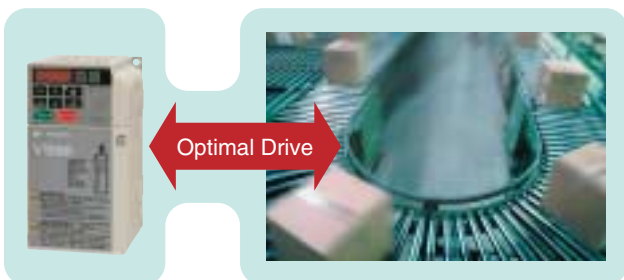
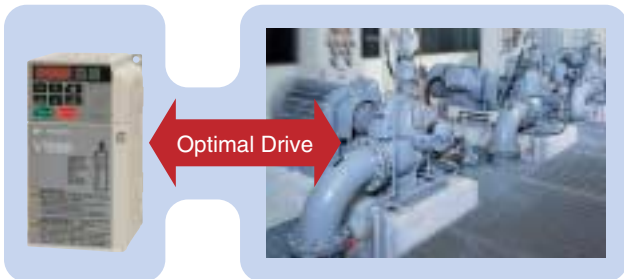

## Hassle-Free Maintenance

### Less Downtime

The first-ever pluggable terminal board with a Parameter Back-Up function lets you replace a drive instantly in the event of failure. No need to re-program the replacement drive—an amazingly convenient time saver!

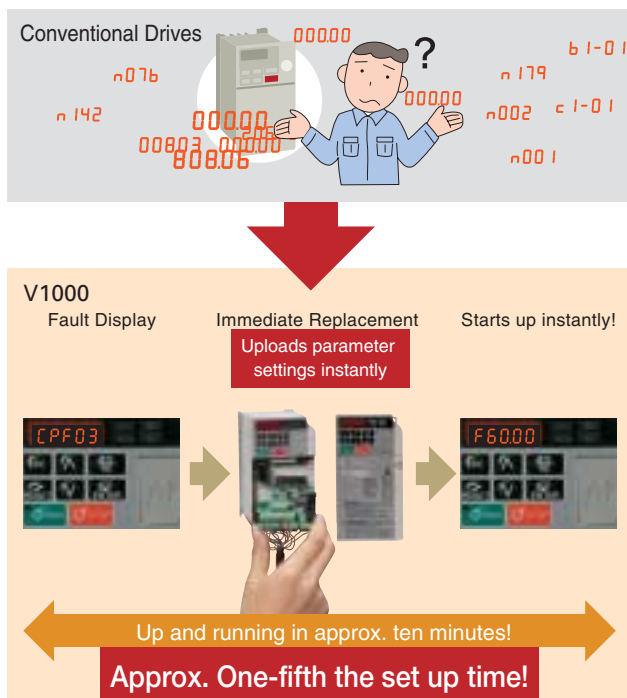

### Exceptional Performance Life

Cooling fan and capacitors have an expected performance life of ten years. In addition, Maintenance Monitors keep track of part wear.

Assumes operation conditions of 40°C, 80% rated load, and 24 hour continuous performance.

### Simple Wiring

Screwless terminals\* (optional) does away with time consuming wiring and periodic maintenance to check wire connections, which in turn makes the drive more reliable.

\*:Available soon

### Wide Array of Monitors

Monitor functions like output frequency, output current, I/O status or watt hour counter give a clear picture about the drive operation status and helps to keep track of the energy consumption.

### Verify Menu

The Verify Menu lists all setting that have been changed from their original default values. This includes parameters changed by Auto-Tuning, Application Presets, and those edited by the technician. This list makes it easy to reference changes to drive setup.

## The world's smallest!

### The perfect space-saving design

### Smallest in its Class

Yaskawa has applied the most advanced thermal simulation technology and top reliability to create the world's smallest compact drive. V1000 reduces the space required by Approx. 70% when compared to our earlier models.

● Compare the size difference of a 200 V 5.5 kW drive with V1000 rated for Normal Duty operation:

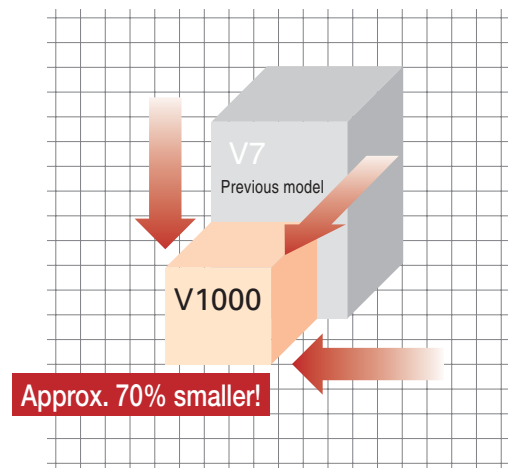

### Side-by-Side

V1000 allows for a truly compact installation, requiring minimal space between units even in a tight enclosure.

● Example: Side-by-Side installation of 200 V 0.75 kW units

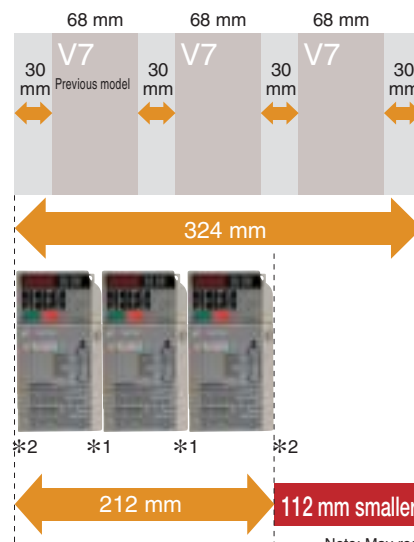

Note: May require torque derating.  
\*1: Drives should be spaced 2 mm apart.  
\*2: Leave a 3 mm gap from the wall.

## Advantages for Each Application

V1000 gets the most out of the application.

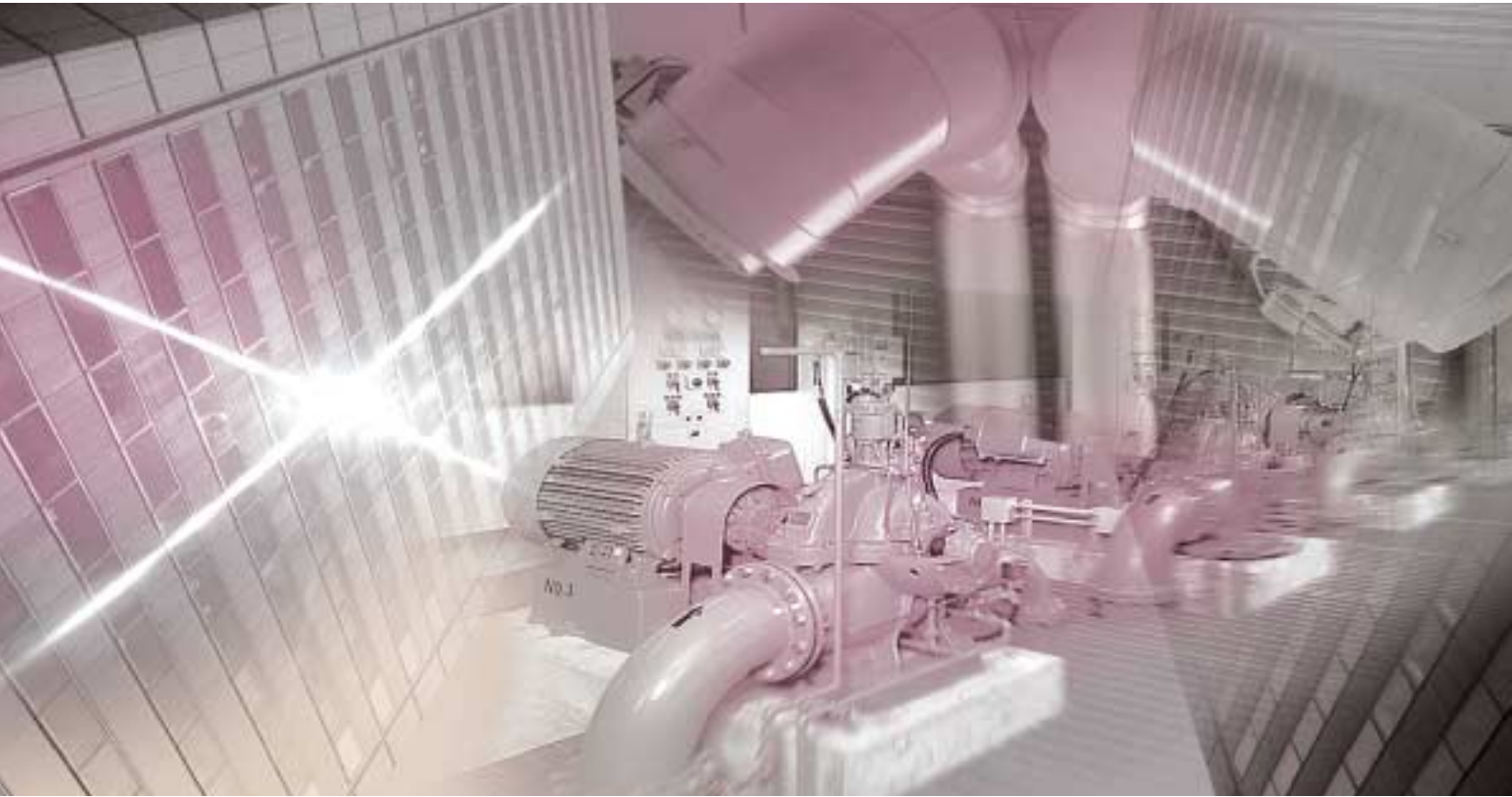

## Fluid Applications

### Advantages

- 1 Selecting “Fan” or “Pump” presets automatically programs V1000 for optimal performance.
- 2 Its compact design saves installation space. Use a permanent magnet motor to shrink the installation even further while conserving impressive amounts of energy.
 

Comparing Overall Efficiency

Motor capacity (kW)	V1000+SMRA motor (%)	JIS high-performance motor drive (%)	Yaskawa induction motor and drive (%)
0.4	~85	~78	~75
0.75	~86	~79	~76
1.5	~87	~80	~77
2.2	~88	~81	~78
3.7	~89	~82	~79

6% higher (at 3.7 kW), 8% higher (at 0.4 kW)

Comparing installation areas

Motor capacity (kW)	Yaskawa induction motor (cm³)	Yaskawa SMRA motor (cm³)
3.7	15,953	4,698

70% down (at 3.7 kW)
- 3 Pulse output provided to keep track of kilowatt hours-no power meter needed. (Cannot legally be used as proof of power consumption.)
- 4 Unique Speed Search functions keep the application running smoothly during momentary power loss.
- 5 An optional 24 V power supply\* lets you monitor drive performance from a PLC even when the power goes out.
- 6 Replace drives immediately and easily thanks to a pluggable terminal board with a built-in Parameter Back-Up function.

### Functions

<b>NEW</b> Application Presets	<b>NEW</b> Watt Hour Pulse Monitor	Undertorque Detection
<b>NEW</b> Overexcitation Braking	Energy Saving Control	Momentary Power Loss Ride-Thru
Speed Search	<b>NEW</b> Drive WorksEZ	Stall Prevention
Multi-Step Speed	<b>NEW</b> PTC Input	<b>NEW</b> Overvoltage Suppression
<b>NEW</b> LOCAL/REMOTE Switch	PID Control	Reference Loss Operation
<b>NEW</b> IM/PM Control	Overtorque Detection	Fault Restart

**NEW** Functions New software functions for V1000.

### Applications



Fan



Pump



HVAC





## Small Size Conveyors

### Advantages

- 1 Selecting the “Conveyor” preset automatically programs V1000 for optimal performance.
- 2 Safety input functions standard. Easily complies with various safety regulations.
- 3 Overexcitation braking provides more powerful braking capabilities.
- 4 Easily customize the drive through visual programming with DriveWorksEZ.
- 5 With a variety of communication protocols options available, V1000 can be networked instantly. A separate 24 V power supply\* is also available, allowing the technician to monitor drive performance from a PLC even when the power goes out.
- 6 IP66 and NEMA 4 Type 1 models\* are available. Provides water-proof and dust-proof protection and separate installation.

\*: Available soon

### Functions

NEW Application Presets	NEW LOCAL/REMOTE Switch	Pulse Train Output
NEW Overexcitation Braking	NEW IM/PM Control	NEW Torque Limit
S-Curve Characteristics	NEW Online Tuning	NEW Current Vector
Multi-Step Speed	NEW Drive WorksEZ	Stall Prevention
Up/Down	Pulse Train Input	Fault Restart

NEW  
New Functions
New software functions for V1000.

### Applications





# Software Functions

## Loaded with software functions just right for your application.

Note: Only major functions are listed.



Upgrade from the V7 to the V1000 with new software.

**NEW**  
Application Presets

**No need to struggle with difficult parameters and complex calculations.** Parameters are set instantly simply by selecting the appropriate Application Preset.

### Functions at Start and Stop

**NEW**  
Optimal Deceleration

**Optimal deceleration without needing to set the deceleration time.** Drive slows the application smoothly controlling regenerative energy.

**NEW**  
Overexcitation Braking

**Perfect for applications with high load inertia that rarely need to be stopped.** Stop quickly—50% faster without the use of a braking resistor. \*Stopping times may vary based on motor characteristics.

DC Injection Braking at Start

**Halt a coasting motor and start it back up again.** When the direction of a coasting motor is unknown, the drive automatically performs DC Injection to bring the motor to a halt and then start it back up again.

Speed Search

**Start a coasting motor.** Automatically brings a coasting motor back to the target frequency without the need for extra speed sensors.

Dwell Function

**Accelerate and decelerate smoothly with large inertia loads.** Drive prevents speed loss by holding the output frequency at a constant level during acceleration and deceleration.

Accel/Decel Time Switch

**Switch easily between accel/decel times.** Switch acceleration and deceleration rates when running to motors from the same drive, or change accel/decel times when operating at high speed.

S-Curve Time

**Prevent sudden shock when starting and stopping the application.** Drive lets the user fine-tune the S-curve characteristics, allowing for smooth acceleration and deceleration.

### Reference Functions

Frequency Reference Upper/Lower Limits

**Limit motor speed.** Set speed limits and do away with the need for extra peripheral devices and extraneous hardware.

Multi-Step Speed

**Easily program a speed sequence with multiple steps.** Set up to 17 separate speeds to create a speed sequence for the application. The drive can easily be connected to a PLC and allow for a simple positioning with limit switches.

Frequency Jump

**Skip over troublesome resonant frequencies.** Drive can be programmed to avoid machine resonance problems by avoiding constant speed operation at certain speed.

Frequency Reference Hold

**Improved operability.** Momentarily holds the operating frequency while accelerating or decelerating as the load is lowered or raised.

Up/Down

**Improved operability.** Raise or lower the frequency reference using a remote switch.

**NEW**  
LOCAL/REMOTE

**Switch between remote operating locations.** Easily switch between controlling the drive directly with the keypad or from a control panel at some remote location.

### Functions during Operation

**NEW**  
IM/PM Control

**Run both IM and PM motors with a single drive.** The most advanced motor drive technology can run both IM and PM motors, allowing for even greater energy savings and a more compact setup.

**NEW**  
Watt-Hour Pulse Monitor

**No extra watt hour meter needed.** A pulse output lets the user monitor power consumption. (Cannot legally be used as proof of power consumption)

Energy Saving

**Automatically runs at top efficiency.** The drive supplies voltage to the motor relative to the speed and load so that the application is for operating at the most efficient level.

**NEW**  
Online Tuning

**Always optimal vector control performance** Online Tuning eliminates the influence of rising motor temperatures and avoids the hassle of fine tuning.

**NEW**  
Current Vector

**Achieve high levels of performance.** The drive comes with current vector control capabilities for high performance applications.

NEW

**Drive WorksEZ****Customize the perfect drive to fit your needs.**

Upper controller circuitry and drive I/O terminals can be programmed so that extra hardware is no longer needed. Drag-and-drop visual programming makes customization a breeze.

NEW

**Timer Function****No need for extra hardware.**

Control timing by opening and closing the output signal relative to the input signal.

NEW

**PTC Input****Thermal protection provided by a PTC located in the motor windings.**

Protect the motor from over heat by directly connecting the PTC to the drive.

**PID Control****Automatic PID control.**

The internal PID controller fine-adjusts the output frequency for precise control of pressure, flow or other process parameters.

NEW

**Motor 2 Switch****One drive runs two motors.**

Use a single drive to operate two different motors. (Only one PM motor may be used)

**Pulse Train Input****Improved operability.**

Use the Pulse Train Input to control not only the frequency reference, but also PID feedback and PID input.

**Pulse Train Output****Improved monitor functions.**

Pulse output lets the user observe everything from the frequency reference and output frequency to motor speed, softstart output frequency, PID feedback, and PID input.

**Frequency Detection****Use frequency detection for brake control.**

The drive can output a signal when the output frequency exceeds a specified level.

**Overtorque Detection****Keep the application running while protecting the machine.**

Overtorque detection senses motor torque to notify the user immediately when a filter clogs or the machine is blocked by mechanical problems.

**Undertorque Detection****Better reliability: Keep the application running while protecting the load.**

Fault detection senses any drop in motor torque due to broken belts or worn transmission.

NEW

**Torque Limit****Better reliability: Keep the application running while protecting the load.**

V1000 helps protect your application by restricting the amount of torque the motor can create.

**Protective Functions****Momentary Power Loss****Keep running even during a momentary loss in power.**

V1000 automatically restarts the motor and keeps the application going in the event of a power loss.

NEW

**KEB Braking****Decelerate to stop when the power goes out.**

V1000 uses regenerative energy from the motor to bring the application to a stop, rather than simply letting it coast.

**Stall Prevention****Better reliability: Keep the application running while protecting the load.**

Keeps the machine running by preventing motor stalling caused by too high load or rapid speed changes.

NEW

**Overtorque Suppression****Avoid overvoltage trip.**

Effective for punching presses and crank shafts where repetitive motion creates large amounts of regenerative energy. The drive increases or decreases the frequency in correspondence with regen levels to prevent overvoltage from occurring.

**Continuous Operation at Reference Loss****Better reliability for continuous operation.**

The drive can keep running at the most recent frequency reference it was given in the event that the upper controller should fail. An absolute must for HVAC systems.

**Fault Restart****No stop by automatic fault**

V1000 has full self-diagnostic features and can restart the application in case of a fault providing continued operation.



# Operation Instructions

Outstanding operability! Separate settings for each application enables quick set-up.



## Operator Names and Functions

- Data display (5-digit)**  
Displays frequency, parameter number, and other data.
- LO/RE light**  
Lights to indicate that the operator is set for LOCAL.
- ESC key**  
Lets the user back up to the previous display screen.
- Right arrow key**  
Scrolls the cursor to the right.
- RESET key**  
Resets a fault.
- RUN light**  
Lights when the Run command is present.
- RUN key**  
Issues a Run command.
- Glossary**  
Used as a quick guide for the abbreviations used on the display screen. Details listed on the next page.

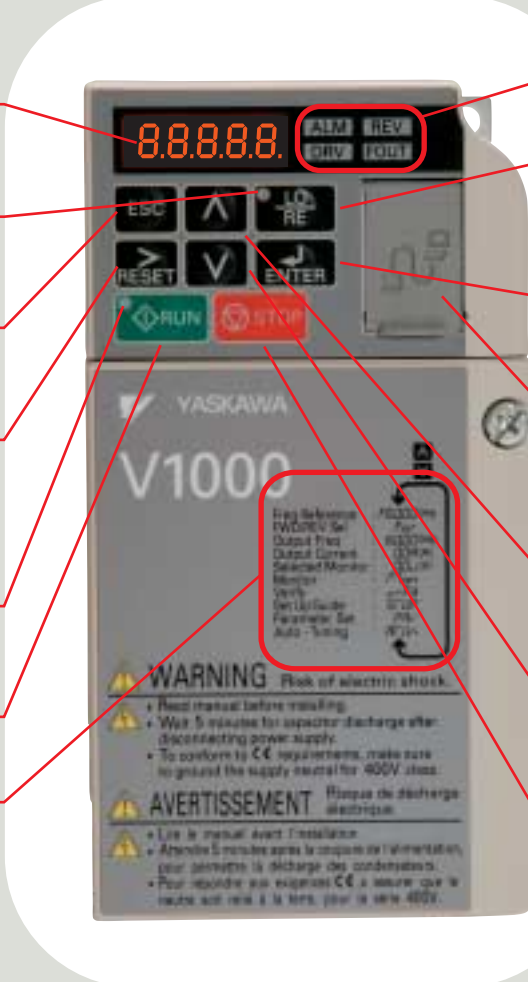

- LED panel**  
More information listed below.
- LO/RE key**  
Determines where the Run command and frequency reference come from: the keypad (LOCAL) or the control terminals (REMOTE).
- ENTER key**  
Press to enter values, edit parameters, and set the control mode. Press this key to proceed to the next screen when scrolling through various menu displays.
- Com port**  
For connecting to a PC (DriveWizard or DriveWorkSEZ), a USB copy unit or a LCD operator.
- Up arrow key**  
Scrolls up through the display screen, and increases a selected value.
- Down arrow key**  
Scrolls down through the display screen, and decreases a selected value.
- STOP key**  
Issues a Stop command.



### LED Display Guide

LED	ON	Flashing	OFF
<b>ALM</b>	A fault has occurred.	Alarm is occurring. Operator error occurred (OPE). Auto-Tuning fault occurred.	Normal operation
<b>REV</b>	Motor is rotating in reverse.	---	Motor is rotating forward.
<b>DRV</b>	In the "Drive Mode" Executing Auto-Tuning	DriveWorksEZ is connected.	Programming Mode
<b>FOUT</b>	Output frequency	---	---
<b>RE</b>	Run command assigned to the operator (LOCAL)	---	Control assigned to remote location
<b>RUN</b>	During run	During deceleration Run command is present but the frequency reference is zero.	Drive is stopped.

### How the RUN light works:

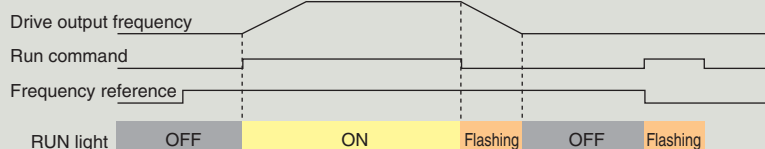

## Operation Example

### Using the LED Operator to Run the Drive

Steps	Key	Result/Display
1 Turn the power on.		F 0.00
2 Set the drive for LOCAL. The frequency reference is displayed.		LO should light. F 0.00
3 Displays the direction (forward).		For
4 Displays the output frequency.		0.00
5 Displays the output current.		0.00A
6 Displays the output voltage.		0.00V
7 Displays the beginning of the Monitor Menu.		flashing r7on
8 Displays the top of the Verify Menu.		flashing urFY
9 Displays the top of the Setup Mode.		flashing srUP
10 Displays the top of the parameter settings menu.		PAR
11 Displays the top of the Auto-Tuning Mode.		ATUn
Returns back to the frequency reference display.		

Value will flash when it is possible to change the setting.  
Press to go back to the previous display screen.

**Drive Mode:** Run and Stop commands, displays operation status such as the frequency reference, output frequency, output current, output voltage, etc.

#### How to Monitor the Frequency Reference

Steps	Key	Result/Display
Use the arrow keys to select the digits to set.		F00.00
		F00.00
		F06.00
		F06.00
Press enter to save the new value.		*End* appears while the drive saves the new data. DRV DRV lights up.

**Monitor Mode:** Displays operation status and information on faults.

Steps	Key	Result/Display
Selecting a Monitor for Display Displays U1-01, the frequency reference monitor. Re-select the monitor display menu.		U1-01
		6.00
		U1-01
		U1-02
		U1-26
Back up to the top of the Monitor Menu.	Press once.	r7on

**Verify Menu:** Lists all parameters that have been changed from their original default settings, either by the user or from Auto-Tuning.

Steps	Key	Result/Display
Lists parameters that have been changed in order. Pressing Enter displays the parameter value. <small>Parameters that have been changed from their default values are listed in order.</small>		C1-01
		00030
		C1-01
		C1-02
		C6-02
Returns to the top of the Verify Menu.	Press once.	urFY

### Setup Mode

The list of Applications Presets can be accessed in the Setup Mode. Each Application Preset automatically programs drive parameters to their optimal settings specific to the application selected. All parameters affected by the Application Preset are then listed as Preferred Parameters for quick access. Selecting a Water Supply Pump (A1-06=1)

Steps	Key	Result/Display
Application Selection		APPL
Select, "Water Supply Pump".		00
		00
		01
		APPL
All parameters relating to the preset values for a water supply pump applications are then listed as Preferred Parameters.	Scroll to the Preferred Parameter using the up arrow key and see which parameters have been selected.	*End* appears while the drive saves the new data.

#### Water Supply Pump Application Presets

No.	Parameter Name	Optimum Setting
A1-02	Control Method Selection	0: V/f control
b1-04	Reverse Operation Selection	1: Reverse disabled
C1-01	Acceleration Time 1	1.0 (sec)
C1-02	Deceleration Time 1	1.0 (sec)
C6-01	Duty Cycle	1: Normal Duty (ND)
E1-03	V/f Pattern Selection	0F (H)
E1-07	Mid Output Frequency (FB)	30.0 (Hz)
E1-08	Mid Output Frequency Voltage (VC)	50.0 (V)
L2-01	Momentary Power Loss Operation Selection	1: Enabled
L3-04	Stall Prevention Selection during Deceleration	1: Enabled

#### Preferred Parameters

No.	Parameter Name	No.	Parameter Name
b1-01	Frequency Reference Selection 1	E1-08	Mid Output Frequency Voltage (VC)
b1-02	Run Command Selection 1	E2-01	Motor Rated Current
b1-04	Reverse Operation Selection	H1-05	Multi-Function Digital Input Terminal S5 Function Selection
C1-01	Acceleration Time 1	H1-06	Multi-Function Digital Input Terminal S6 Function Selection
C2-02	Deceleration Time 1	H1-07	Multi-Function Digital Input Terminal S7 Function Selection
E1-03	V/f Pattern Selection	L5-01	Number of Auto Restart Attempts
E1-07	Mid Output Frequency (FB)	-	-

# Product System

Number in parenthesis indicates the rated output current when running the largest motor allowed.

Model	Three-Phase 200 V		Single-Phase 200 V		Three-Phase 400 V	
	Normal Duty	Heavy Duty	Normal Duty	Heavy Duty	Normal Duty	Heavy Duty
0001	0.2 kW (1.2 A)	0.1 kW (0.8 A)	0.2 kW (1.2 A)	0.1 kW (0.8 A)	0.4 kW (1.2 A)	0.2 kW (1.2 A)
0002	0.4 kW (1.9 A)	0.2 kW (1.6 A)	0.4 kW (1.9 A)	0.2 kW (1.6 A)	0.75 kW (2.1 A)	0.4 kW (1.8 A)
0003			0.75 kW (3.3 A)	0.4 kW (3 A)		
0004	0.75 kW (3.5 A)	0.4 kW (3 A)			1.5 kW (4.1 A)	0.75 kW (3.4 A)
0005					2.2 kW (5.4 A)	1.5 kW (4.8 A)
0006	1.1 kW (6 A)	0.75 kW (5 A)	1.1 kW (6 A)	0.75 kW (5 A)		
0007					3.0 kW (6.9 A)	2.2 kW (5.5 A)
0008	1.5 kW (8 A)	1.1 kW (6.9 A)				
0009					3.7 kW (8.8 A)	3.0 kW (7.2 A)
0010	2.2 kW (9.6 A)	1.5 kW (8 A)	2.2 kW (9.6 A)	1.5 kW (8 A)		
0011					5.5 kW (11.1 A)	3.7 kW (9.2 A)
0012	3.0 kW (12 A)	2.2 kW (11 A)	3.0 kW (12 A)	2.2 kW (11 A)		
0018	3.7 kW (17.5 A)	3.0 kW (14 A)		3.7 kW (17.5 A)	7.5 kW (17.5 A)	5.5 kW (14.8 A)
0020	5.5 kW (19.6 A)	3.7 kW (17.5 A)				
0023					11 kW (23 A)	7.5 kW (18 A)
0030	7.5 kW (30 A)	5.5 kW (25 A)				
0031					15 kW (31 A)	11 kW (24 A)
0038					18.5 kW (38 A)	15 kW (31 A)
0040	11 kW (40 A)	7.5 kW (33 A)				
0056	15 kW (56 A)	11 kW (47 A)				
0069	18.5 kW (69 A)	15 kW (60 A)				

## Understanding the Model Number

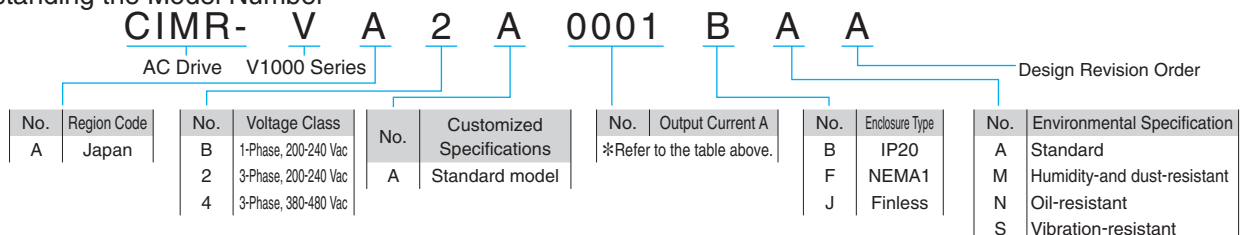

Note: Contact Yaskawa for more information on environmental tolerance specifications.

## Optimizing Control for Each Application

V1000 offers two separate performance ratings: Normal Duty and Heavy Duty.  
A single parameter lets the user determine which rating is best suits the application.

Difference between load ratings:

	Normal Duty Rating	Heavy Duty Rating
Parameter settings	C6-01 = 1 (default)	C6-01=0
Major applications	Fans, pumps...	Conveyors, cart transport...
Overload tolerance	120% for 60 s	150% for 60 s
Carrier frequency	Low carrier frequency (default)	High carrier frequency*

\*: Varies by model

## Model Selection by Motor Capacity

Normal Duty Rating:

Max. Applicable Motor Capacity kW	Power Supply	200 V		400 V
		Three-Phase	Single-Phase	Three-Phase
		V1000		
Model	CIMR-VA2A□□□□	CIMR-VABA□□□□	CIMR-VA4A□□□□	
0.2		0001	0001	0001
0.4		0002	0002	0001
0.75		0004	0003	0002
1.5		0008	0010	0004
2.2		0010	0010	0005
3.7		0018	—	0009
5.5		0020	—	0011
7.5		0030	—	0018
11		0040	—	0023
15		0056	—	0031
18.5		0069	—	0038

Heavy Duty Rating and model reference for VS-606V7

Max. Applicable Motor Capacity kW	Power Supply	200 V				400 V	
		Three-Phase		Single-Phase		Three-Phase	
		V1000	VS-606V7	V1000	VS-606V7	V1000	VS-606V7
Model	CIMR-VA2A□□□□	CIMR-V7AA2□□□	CIMR-VABA□□□□	CIMR-V7AAB□□□	CIMR-VA4A□□□□	CIMR-V7AA4□□□	
0.1		0001	0P1	0001	0P1	—	—
0.2		0002	0P2	0002	0P2	0001	0P2
0.4		0004	0P4	0003	0P4	0002	0P4
0.75		0006	0P7	0006	0P7	0004	0P7
1.5		0010	1P5	0010	1P5	0005	1P5
2.2		0012	2P2	0012	2P2	0007	2P2
3.7		0020	3P7	0018	3P7	0011	3P7
5.5		0030	5P5	—	—	0018	5P5
7.5		0040	7P5	—	—	0023	7P5
11		0056	—	—	—	0031	—
15		0069	—	—	—	0038	—

# Standard Specifications

## 200 V Class (Three-phase/Single-phase)

Value inside parenthesis is for a single-phase drive.

Model	Three-Phase CIMR-VA2A: [ ]	0001	0002	0004	0006	0008	0010	0012	0018	0020	0030	0040	0056	0069			
	Single-Phase*2 CIMR-VABA: [ ]	0001	0002	0003	0006	-	0010	0012	-	0018*1	-	-	-	-			
Max. Applicable Motor Capacity*3	kW	Normal Duty	0.2	0.4	0.75	1.1	1.5	2.2	3.0	3.7	5.5	7.5	11.0	15.0	18.5		
		Heavy Duty	0.1	0.2	0.4	0.75	1.1	1.5	2.2	3.0	3.7	5.5	7.5	11.0	15.0		
Input	Rated Input Current*4	A	Three-phase	Normal Duty	1.1	1.9	3.9	7.3	8.8	10.8	13.9	18.5	24.0	34.7	50.9	69.4	85.6
			Heavy Duty	0.7	1.5	2.9	5.8	7.0	7.5	11.0	15.6	18.9	26.0	35.4	51.9	70.8	
		Single-phase	Normal Duty	2.0	3.6	7.3	13.8	-	20.2	24.0	-	-	-	-	-	-	
			Heavy Duty	1.4	2.8	5.5	11.0	-	14.1	20.6	-	35.0	-	-	-	-	
Rated Output Capacity*5	kVA	Normal Duty	0.5	0.7	1.3	2.3	3.0	3.7	4.6	6.7	7.5	11.4	15.2	21.3	26.3		
		Heavy Duty	0.3	0.6	1.1	1.9	2.6	3.0	4.2	5.3	6.7	9.5	12.6	17.9	22.9		
Rated Output Current	A	Normal Duty*6	1.2	1.9	3.5 (3.3)	6.0	8.0	9.6	12.0	17.5	19.6	30.0	40.0	56.0	69.0		
		Heavy Duty	0.8*7	1.6*7	3.0*7	5.0*7	6.9*8	8.0*8	11.0*8	14.0*8	17.5*8	25.0*8	33.0*8	47.0*8	60.0*8		
Overload Tolerance		Normal Duty Rating: 120% of rated output current for 60 s. Heavy Duty Rating: 150% of rated output current for 60 s. (Derating may be required for repetitive loads)															
Carrier Frequency		2 kHz (user-set, up to 15 kHz possible)															
Max. Output Voltage		Three-Phase Power Supply: Three-Phase 200 to 240 V (relative to input voltage) Single-Phase Power Supply: Three-Phase 200 to 240 V (relative to input voltage)															
Max. Output Frequency		400 Hz															
Rated Voltage/Rated Frequency		Three-Phase Power Supply: Three-Phase 200 to 240 V 50/60 Hz Single-Phase Power Supply: Single-Phase 200 to 240 V 50/60 Hz															
Allowable Voltage Fluctuation		-15 to 10%															
Allowable Frequency Fluctuation		±5%															
Power	Power Supply	kVA	Three-phase	Normal Duty	0.5	0.9	1.8	3.3	4.0	4.9	6.4	8.5	11.0	17.0	24.0	31.0	37.0
			Heavy Duty	0.3	0.7	1.3	2.7	3.2	3.4	5.0	7.1	8.6	11.0	17.0	24.0	31.0	
		Single-phase	Normal Duty	0.5	1.0	1.9	3.6	-	5.3	6.3	-	-	-	-	-	-	
			Heavy Duty	0.4	0.7	1.5	2.9	-	3.7	5.4	-	9.2	-	-	-	-	

\*1: Heavy Duty (3.7 kW) only.

\*2: Drives with a single-phase power supply input have Three-phase output. Single-phase motors cannot be used.

\*3: Based on motor data of Yaskawa 4-pole, 60 Hz standard motors. Motor rated current should not exceed drive rated output current.

\*4: Value shown is for when operating at the rated output current. This value may fluctuate based on the power supply side impedance, as well as the input current, power supply transformer, input side reactor, and wiring conditions.

\*5: Rated output capacity is calculated with a rated output voltage of 220 V.

\*6: This value assumes a carrier frequency of 2 kHz. Increasing the carrier frequency requires a reduction in current.

\*7: This value assumes a carrier frequency of 10 kHz. Increasing the carrier frequency requires a reduction in current.

\*8: This value assumes a carrier frequency of 8 kHz. Increasing the carrier frequency requires a reduction in current.

## 400 V Class (Three-phase)

Model	CIMR-VA4A: [ ]	0001	0002	0004	0005	0007	0009	0011	0018	0023	0031	0038		
Max. Applicable Motor Capacity*1	kW	Normal Duty	0.4	0.75	1.5	2.2	3.0	3.7	5.5	7.5	11.0	15.0	18.5	
		Heavy Duty	0.2	0.4	0.75	1.5	2.2	3.0	3.7	5.5	7.5	11.0	15.0	
Input	Rated Input Current*2	A	Normal Duty	1.2	2.1	4.3	5.9	8.1	9.4	14.0	20.0	24.0	38.0	44.0
			Heavy Duty	1.2	1.8	3.2	4.4	6.0	8.2	10.4	15.0	20.0	29.0	39.0
Rated Output Capacity*3	kVA	Normal Duty*4	0.9	1.6	3.1	4.1	5.3	6.7	8.5	13.3	17.5	23.6	29.0	
		Normal Duty*5	0.9	1.4	2.6	3.7	4.2	5.5	7.0	11.3	13.7	18.3	23.6	
Rated Output Current	A	Heavy Duty*4	1.2	2.1	4.1	5.4	6.9	8.8	11.1	17.5	23.0	31.0	38.0	
		Heavy Duty*5	1.2	1.8	3.4	4.8	5.5	7.2	9.2	14.8	18.0	24.0	31.0	
Overload Tolerance		Normal Duty Rating: 120% of rated output current for 60 s. Heavy Duty Rating: 150% of rated output current for 60 s. (Derating may be required for repetitive loads)												
Carrier Frequency		2 kHz (user-set, up to 15 kHz possible)												
Max. Output Voltage		Three-phase 380 to 480 V (relative to input voltage)												
Max. Output Frequency		400 Hz (user-set)												
Rated Voltage/Rated Frequency		Three-phase 380 to 480 V 50/60 Hz												
Allowable Voltage Fluctuation		-15 to 10%												
Allowable Frequency Fluctuation		±5%												
Power	Power Supply	kVA	Normal Duty	1.1	1.9	3.9	5.4	7.4	8.6	13.0	18.0	22.0	35.0	40.0
			Heavy Duty	1.1	1.6	2.9	4.0	5.5	7.5	9.5	14.0	18.0	27.0	36.0

\*1: Based on motor data of Yaskawa 4-pole, 60 Hz standard motors. Motor rated current should not exceed the drive rated output current.

\*2: Value shown is for when operating at the rated output current. This value may fluctuate based on the power supply side impedance, as well as the input current, power supply transformer, input side reactor, and wiring conditions.

\*3: Value displayed is for when operating at the rated output current. Rated output capacity is calculated with a rated output voltage of 440 V.

\*4: This value assumes a carrier frequency of 2 kHz. Increasing the carrier frequency requires a reduction in current.

\*5: This value assumes a carrier frequency of 8 kHz. Increasing the carrier frequency requires a reduction in current.



## Common Specifications

Rotational Auto-Tuning must be performed to achieve the performance described with Open Loop Vector Control.

ITEM		SPECIFICATIONS
Control Characteristics	Control Method	Open Loop Vector Control (Current Vector), V/f Control, PM Open Loop Vector Control (for SPM and IPM motors)
	Frequency Control Range	0.01 to 400 Hz
	Frequency Accuracy (Temperature Fluctuation)	Digital Input : within $\pm 0.01\%$ of the max. output frequency ( $-10$ to $+50^{\circ}\text{C}$ )
		Analog Input: within $\pm 0.1\%$ of the max. output frequency ( $25^{\circ}\text{C} \pm 10^{\circ}\text{C}$ )
	Frequency Setting Resolution	Digital Input : 0.01 Hz
		Analog Input: 1/1000 of max. frequency
	Output Frequency Resolution	$1/2^{20}$ of maximum output frequency (parameter E1-04 setting)
	Frequency Setting Resolution	Main frequency Reference: 0 to +10 Vdc (20 k $\Omega$ ), 4 to 20 mA (250 $\Omega$ ), 0 to 20 mA (250 $\Omega$ ) Main speed reference : Pulse Train Input max. 32 kHz
	Starting Torque	200% / 0.5 Hz (assumes Heavy Duty rating IM of 3.7 kW or less using Open Loop Vector Control), 50% / 6 Hz (assumes Open Loop Vector Control for PM motors)
	Speed Control Range	1:100 (Open Loop Vector Control), 1:20 to 40 (V/f Control), 1:10 (PM Open Loop Vector Control)
	Speed Control Accuracy	$\pm 0.2\%$ in Open Loop Vector Control ( $25^{\circ}\text{C} \pm 10^{\circ}\text{C}$ ) *1
	Speed Response	5 Hz in Open Loop Vector ( $25^{\circ}\text{C} \pm 10^{\circ}\text{C}$ )
	Torque Limit	Open Loop Vector Control allows separate settings in four quadrants
	Accel/Decel Time	0.0 to 6000.0 sec (4 selectable combinations of independent acceleration and deceleration settings)
Protection Function	Braking Torque	① Short-time decel torque*2: over 150% for 0.1/0.2 kW motors, over 100% for 0.4/ 0.75 kW motors, over 50% for 1.5 kW motors, and over 20% for 2.2 kW and above motors (overexcitation braking/High-Slip Braking: approx. 40%). ② Continuous regen. torque: approx. 20% (approx. 125% with dynamic braking resistor option*3: 10% ED, 10 s, internal braking transistor)
	V/f Characteristics	User-selected programs, V/f preset patterns possible
	Main Control Functions	Momentary Power Loss Ride-Thru, Speed Search, Overtorque Detection, Torque Limit, 17-Step Speed (max), Accel/Decel Time Switch, S-Curve Accel/Decel, 3-Wire Sequence, Auto-Tuning (Rotational, Stationary Tuning for Resistance between Lines), Dwell, cooling fan on/off switch, Slip Compensation, Torque Compensation, Frequency Jump, upper/lower limits for frequency reference, DC Injection braking at start and stop, High Slip Braking, PID Control (with sleep function), Energy Saving Control, Memobus Comm. (RS-485/422 max, 115.2 kbps), Fault Restart, Application Presets, DriveWorksEZ (customized function), removable terminal block with Parameter Backup Function...
Protection Function	Motor Protection	Motor overheat protection based on output current
	Momentary Overcurrent Protection	Drive stops when output current exceeds 200% of Heavy Duty Rating
	Overload Protection	Drive stops after 60 s at 150% of rated output current (Heavy Duty Rating)*4
	Overvoltage Protection	200 V class: Stops when DC bus exceeds Approx. 410 V
		400 V class: Stops when DC bus exceeds Approx. 820 V
	Undervoltage Protection	Stops when DC bus voltage falls below the following levels: Three-phase 200 V class: Approx. 190 V, Single-phase 200 V class: Approx. 160 V, Three-phase 400 V class: Approx. 380 V, Three-phase 380 V class: Approx. 350 V
	Momentary Power Loss Ride-Thru	Stops after Approx. 15 ms (default). Parameter settings allow the drive to continue running if power loss lasts for up to Approx. 2 s *5
	Heatsink Overheat Protection	Protection by thermistor
	Braking Resistance Overheat Protection	Overheat sensor for braking resistor (optional ERF-type, 3% ED)
	Stall Prevention	Separate settings allowed during acceleration, and during run. Enable/disable only during deceleration.
Operating Environment	Ground Fault Protection	Protection by electronic circuit *6
	Charge LED	Charge LED remains lit until DC bus has fallen below Approx. 50 V
	Area of Use	Indoors
	Ambient Temperature	$-10$ to $+50^{\circ}\text{C}$ (open chassis), $-10$ to $+40^{\circ}\text{C}$ (NEMA 1 Type 1)
	Humidity	95 RH% or less (no condensation)
	Storage Temperature	$-20$ to $+60^{\circ}\text{C}$ (short-term temperature during transportation)
	Altitude	Up to 1000 meters
	Shock	10 to less than 20 Hz (9.8 m/s <sup>2</sup> ) max., 20 to 50 Hz (5.9 m/s <sup>2</sup> ) max
	Safety Standard	UL508C, EN954-1 Cat. 3, IEC/EN61508 SIL2
	Protection Design	IP20 open-chassis, NEMA 1 enclosure

\*1: Speed control accuracy may vary slightly depending on installation conditions or motor used.

\*2: Momentary average deceleration torque refers to the deceleration torque from 60Hz down to 0 Hz. This may vary depending on the motor.

\*3: Parameter L3-04 should be disabled when a braking resistor or Dynamic Braking Resistor Unit is connected.

\*4: Overload protection may be triggered at lower levels if output frequency is below 6 Hz.

\*5: Varies by drive capacity. Drives smaller than 7.5 kW (CIMR-VA2A0004/CIMR-VA4A0023) require a separate Momentary Power Loss Ride-Thru device to continue operating during a momentary power loss of two seconds.

\*6: Protection may not be provided under the following conditions as the motor windings are grounded internally during run:

- Low resistance to ground from the motor cable or terminal block.
- Drive already has a short-circuit when the power is turned on.



# Standard Connection Diagram

## Standard Connection Diagram

Example of 200 V Class

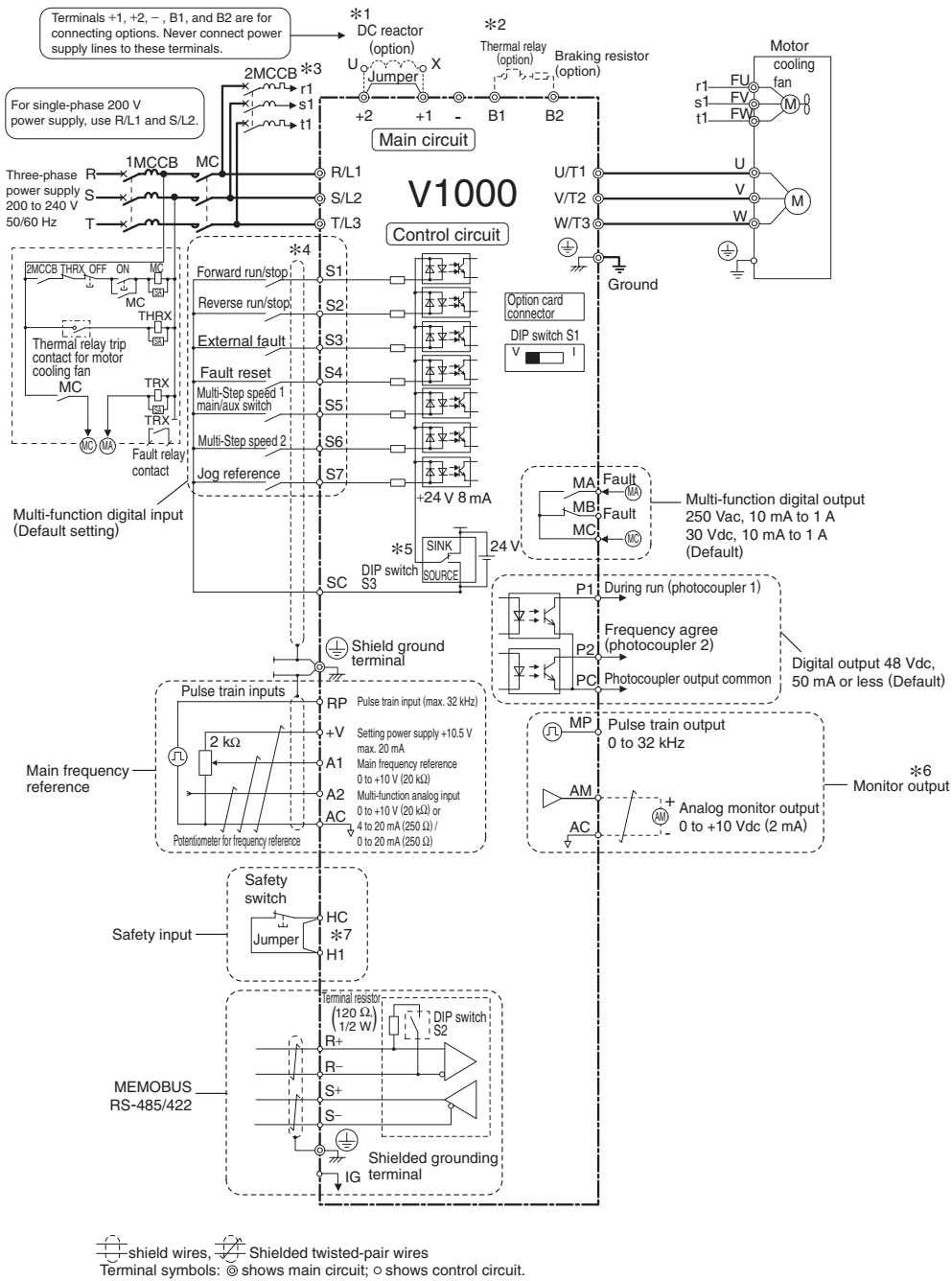

- \*1: Remove the jumper between terminals +1 and +2 when installing an optional DC reactor.
  - \*2: The MC on the input side of the main circuit should open when the thermal relay is triggered.
  - \*3: Self-cooled motors do not require separate cooling fan motor wiring.
  - \*4: Connected using sequence (0 V com/sink mode) input signal (S1 to S7) from NPN transistor (default).
  - \*5: In the sinking mode the internal 24 Vdc power supply must be used. Source mode requires an external power supply.
  - \*6: Monitor outputs work with devices such as analog frequency meters, ammeters, voltmeters and watt meters. All are to be used as feedback
  - \*7: When using an external switch to stop the drive as a safety precaution, make sure the jumper creating the short circuit has been removed. The time between activation of the safety input and shutdown of the output is 1 ms. Be sure that the wiring length for the safety input is 30 m max.
- Note: Input terminal functions may change when Application Presets are used.

### Control Circuit and Terminal Layout

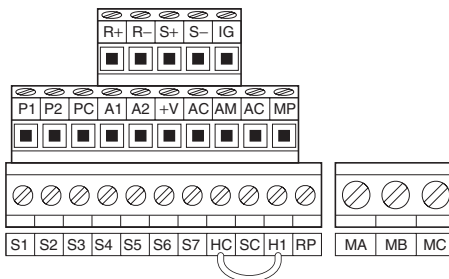

## Terminal Functions

### Main Circuit Terminal

Terminal	Terminal Name	Function (Signal Level)
R/L1	Main circuit power supply input	Connects line power to the drive. Drives with single phase 200 V input power use terminals R/L1 and S/L2 only (T/L3 must not be used).
S/L2		
T/L3		
U/T1	Drive output	Connects to the motor.
V/T2		
W/T3		
B1	Braking resistor	Available for connecting a Braking resistor or an optional Dynamic braking resistor unit.
B2		
+1	DC reactor connection	These terminals are shorted for shipment. Remove the jumper creating the short to install a DC choke.
+2		
+1		
—	DC power supply input	For connecting a DC power supply. Note: DC power supply input terminals (+1, -) are not UL/cUL and CE certified.
—		
⊕ Two terminals	Ground	Grounding terminal Grounding resistance for 200 V class: 100 Ω or less Grounding resistance for 400 V class: 10 Ω or less

Note: Contact your Yaskawa representative if the input terminals for the DC power supply are required to meet UL/cUL and CE standards.

### Control Circuit Input Terminals

Terminal	No.	Terminal Name (Function)	Function (Signal Level) Default Setting
Multi-function digital inputs	S1	Multi-function input 1	Closed: Forward run (default) Open: Stop Photocoupler 24 Vdc, 8 mA Note: Drive preset to sinking mode. When using source mode, set DIP switch S3 to allow for a 24 Vdc (±10%) external power supply.
	S2	Multi-function input 2	
	S3	Multi-function input 3	
	S4	Multi-function input 4	
	S5	Multi-function input 5	
	S6	Multi-function input 6	
	S7	Multi-function input 7	
	SC	Multi-function input common (Control common)	
Main frequency reference input	RP	Multi-function pulse train input	Input frequency: 0.5 to 32 kHz (Duty cycle: 30 to 70%) (High level voltage: 3.5 to 13.2 V) (Low level voltage: 0.0 to 0.8 V) (input impedance: 3 kΩ)
	+V	Analog input power supply	+10.5 V (max. allowable current 20 mA)
	A1	Main frequency reference	Input voltage 0 to +10 VDC (20 kΩ) resolution: 1/1000
	A2	Multi-function analog input	Input voltage or input current 0 to +10 VDC (20 kΩ) resolution: 1/1000 4 to 20 mA or 0 to 20 mA (250 Ω) resolution: 1/500
	AC	Frequency reference common	0 V
Hardwire baseblock	HC	Power supply for hardwire baseblock command	+24 VDC (max. 10 mA allowed)
	H1	Safety Input	Open: Hardwire baseblock Closed: Normal operation · Remove the jumper when an external safety switch is installed to stop the drive. · The time between activation of the safety input and shutdown of the output is 1 ms. · Be sure that the wiring length for the safety input is 30 m max.
Multi-function digital output	MA	N.O. output	Digital output 30 VDC, 10 mA to 1 A 250 VAC, 10 mA to 1 A
	MB	N.C. output	
	MC	Digital output common	
Multi-function photocoupler output	P1	Photocoupler output 1	Photocoupler output * 48 VDC, 50 mA (or less)
	P2	Photocoupler output 2	
	PC	Photocoupler output common	
Monitor output	MP	Pulse train output	32 kHz (max.)
	AM	Analog monitor output	0 to 10 VDC (2 mA or less) Resolution: 1/1000
	AC	Monitor common	0 V

\*: Connect a flywheel diode as shown in Figure on the right when driving a reactive load such as a relay coil. Make sure the diode rating is greater than the circuit voltage.

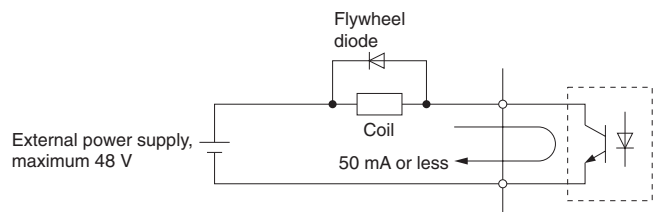

### Serial Communication Terminals

Type	No.	Terminal Name	Function (Signal Level)
MEMOBUS communication	R+	Communications input (+)	MEMOBUS communication: · Use a RS-485 or RS-422 cable to connect the drive. · RS-485/422 MEMOBUS communication protocol 115.2 kbps (max.)
	R-	Communications input (-)	
	S+	Communications output (+)	
	S-	Communications output (-)	
	IG	Shielded ground	0 V



# Dimensions

## Enclosures

### Open-Chassis (IP20)

Models shown in figures 1 through 4 come standard with a IP20 open-chassis design. Use the NEMA 1 kit available for an enclosure panel installation. For more details, contact Yaskawa directly.

### Enclosure Panel (NEMA 1 Type 1)

Model numbers displaying an asterisk come standard with a NEMA Type 1 enclosure. Simply open the top and bottom covers for an open-chassis design compliant with IP00.

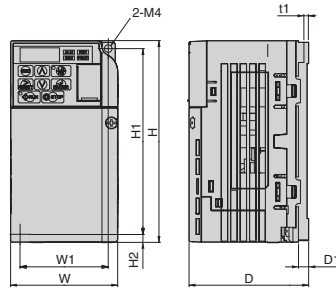

Figure 1

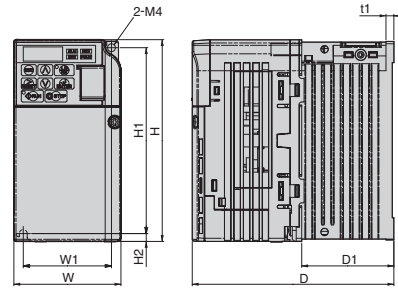

Figure 2

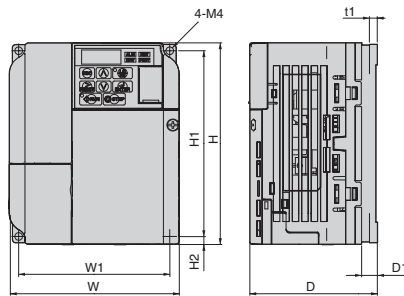

Figure 3

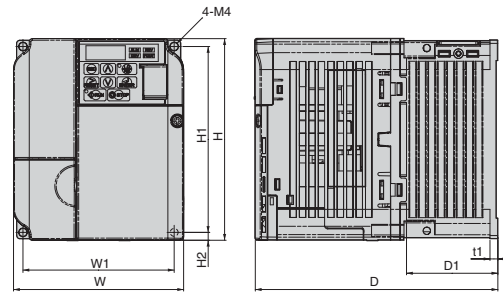

Figure 4

Voltage Class	Model CIMR- VA	Figure	Dimensions (mm)									Weight kg	Cooling
			W	H	D	W1	H1	H2	D1	t1	Mtg. Holes		
200 V Class Three-phase	2A0001	1	68	128	76	56	118	5	6.5	3	M4	0.6	Self-cooled
	2A0002		68	128	76	56	118	5	6.5	3	M4	0.6	
	2A0004	2	68	128	108	56	118	5	38.5	5	M4	0.9	Self-cooled
	2A0006		68	128	128	56	118	5	58.5	5	M4	1.1	
	2A0008	4	108	128	129	96	118	5	58	5	M4	1.7	Fan cooled
	2A0010		108	128	129	96	118	5	58	5	M4	1.7	
	2A0012		108	128	137.5	96	118	5	58	5	M4	1.7	
	2A0018		140	128	143	128	118	5	65	5	M4	2.4	
	2A0020	*	140	128	143	128	118	5	65	5	M4	2.4	Fan cooled
	2A0030		140	254	140	122	248	13	55	5	M5	3.8	
	2A0040		140	254	140	122	248	13	55	5	M5	3.8	
	2A0056		180	290	163	160	284	13	75	5	M5	5.5	
2A0069			220	350	187	192	336	30	78	5	M6	9.2	
200 V Class Single-phase	BA0001	1	68	128	76	56	118	5	6.5	3	M4	0.6	Self-cooled
	BA0002		68	128	76	56	118	5	6.5	3	M4	0.6	
	BA0003	2	68	128	118	56	118	5	38.5	5	M4	1.0	Self-cooled
	BA0006		108	128	137.5	96	118	5	58	5	M4	1.7	
	BA0010		108	128	154	96	118	5	58	5	M4	1.8	
	BA0012		140	128	163	128	118	5	65	5	M4	2.4	
BA0018	170	128	180	158	118	5	65	5	M4	3.0	Fan cooled		
400 V Class Three-phase	4A0001	3	108	128	81	96	118	5	10	5	M4	1.0	Self-cooled
	4A0002		108	128	99	96	118	5	28	5	M4	1.2	
	4A0004		108	128	137.5	96	118	5	58	5	M4	1.7	
	4A0005	4	108	128	154	96	118	5	58	5	M4	1.7	Fan cooled
	4A0007		108	128	154	96	118	5	58	5	M4	1.7	
	4A0009		108	128	154	96	118	5	58	5	M4	1.7	
	4A0011		140	128	143	128	118	5	65	5	M4	2.4	
	4A0018	*	140	254	140	122	248	13	55	5	M5	3.8	Fan cooled
	4A0023		140	254	140	122	248	13	55	5	M5	3.8	
	4A0031		180	290	143	160	284	13	55	5	M5	5.2	
4A0038			180	290	163	160	284	13	75	5	M5	5.5	

## Drive Watts Loss Data

### Normal Duty Ratings

Voltage Class	Model Number CIMR-VA2A: [ ]		0001	0002	0004	0006	0008	0010	0012	0018	0020	0030	0040	0056	0069		
200 V Class Three-Phase	Rated Output Current		A	1.2	1.9	3.5	6.0	8.0	9.6	12.0	17.5	19.6	30.0	40.0	56.0	69.0	
	Heat Loss	Heatsink		W	5.0	7.6	15.8	27.5	44.6	51.7	61.3	89.8	98.7	246.4	266.7	357.9	461.7
		Internal		W	8.0	9.5	13.6	17.2	24.0	25.8	30.4	44.1	46.3	88.9	112.8	151.8	184.5
		Total Heat Loss		W	13.0	17.1	29.4	44.7	68.6	77.5	91.7	133.9	145.0	335.3	379.5	509.7	646.2
Voltage Class	Model Number CIMR-VABA: [ ]		0001	0002	0003	0006	—	0010	0012	—	—	—	—	—	—		
200 V Class Single-Phase	Rated Output Current		A	1.2	1.9	3.3	6.0	—	9.6	12.0	—	—	—	—	—	—	
	Heat Loss	Heatsink		W	5.0	7.6	14.6	30.1	—	51.7	61.3	—	—	—	—	—	
		Internal		W	8.5	9.7	14.4	19.4	—	29.8	37.1	—	—	—	—	—	
		Total Heat Loss		W	13.5	17.3	29.0	49.5	—	81.5	98.4	—	—	—	—	—	
Voltage Class	Model Number CIMR-VA4A: [ ]		0001	0002	0004	0005	—	0007	0009	—	0011	0018	0023	0031	0038		
400 V Class Three-Phase	Rated Output Current		A	1.2	2.1	4.1	5.4	—	6.9	8.8	—	11.1	17.5	23.0	31.0	38.0	
	Heat Loss	Heatsink		W	10.0	18.5	30.5	44.5	—	58.5	63.7	—	81.7	181.2	213.4	287.5	319.2
		Internal		W	9.6	13.9	16.8	21.8	—	28.5	31.4	—	46.0	80.1	107.7	146.1	155.8
		Total Heat Loss		W	19.6	32.4	47.3	66.3	—	87.0	95.1	—	127.7	261.3	321.1	433.6	475.0

The heat loss data are based on a carrier frequency of 2 kHz (Default).

### Heavy Duty Ratings

Voltage Class	Model Number CIMR-VA2A: [ ]		0001*1	0002*1	0004*1	0006*1	0008*1	0010*2	0012*2	0018*2	0020*2	0030*2	0040*2	0056*2	0069*2		
200 V Class Three-Phase	Rated Output Current		A	0.8	1.6	3.0	5.0	6.9	8.0	11.0	14.0	17.5	25.0	33.0	47.0	60.0	
	Heat Loss	Heatsink		W	4.3	7.9	16.1	27.4	48.7	54.8	70.7	92.6	110.5	231.5	239.5	347.6	437.7
		Internal		W	7.3	8.8	11.5	15.9	22.2	23.8	30.0	38.8	43.3	72.2	81.8	117.6	151.4
		Total Heat Loss		W	11.6	16.7	27.6	43.3	70.9	78.6	100.7	131.4	153.8	303.7	321.3	465.2	589.1
Voltage Class	Model Number CIMR-VABA: [ ]		0001*1	0002*1	0003*1	0006*1	—	0010*2	0012*2	—	0018*2	—	—	—	—		
200 V Class Single-Phase	Rated Output Current		A	0.8	1.6	3.0	5.0	—	8.0	11.0	—	17.5	—	—	—	—	
	Heat Loss	Heatsink		W	4.3	7.9	16.1	33.7	—	54.8	70.7	—	110.5	—	—	—	
		Internal		W	7.4	8.9	11.5	16.8	—	25.9	34.1	—	51.4	—	—	—	
		Total Heat Loss		W	11.7	16.8	27.6	50.5	—	80.7	104.8	—	161.9	—	—	—	
Voltage Class	Model Number CIMR-VA4A: [ ]		0001*2	0002*2	0004*2	0005*2	—	0007*2	0009*2	—	0011*2	0018*2	0023*2	0031*2	0038*2		
400 V Class Three-Phase	Rated Output Current		A	1.2	1.8	3.4	4.8	—	5.5	7.2	—	9.2	14.8	18.0	24.0	31.0	
	Heat Loss	Heatsink		W	19.2	28.9	42.3	70.7	—	81.0	84.6	—	107.2	166.0	207.1	266.9	319.1
		Internal		W	11.4	14.9	17.9	26.2	—	30.7	32.9	—	41.5	62.7	78.1	105.9	126.6
		Total Heat Loss		W	30.6	43.8	60.2	96.9	—	111.7	117.5	—	148.7	228.7	285.2	372.8	445.7

\*1: The heat loss data are based on a carrier frequency of 10 kHz (Default).

\*2: The heat loss data are based on a carrier frequency of 8 kHz (Default).



# Peripheral Devices and Options

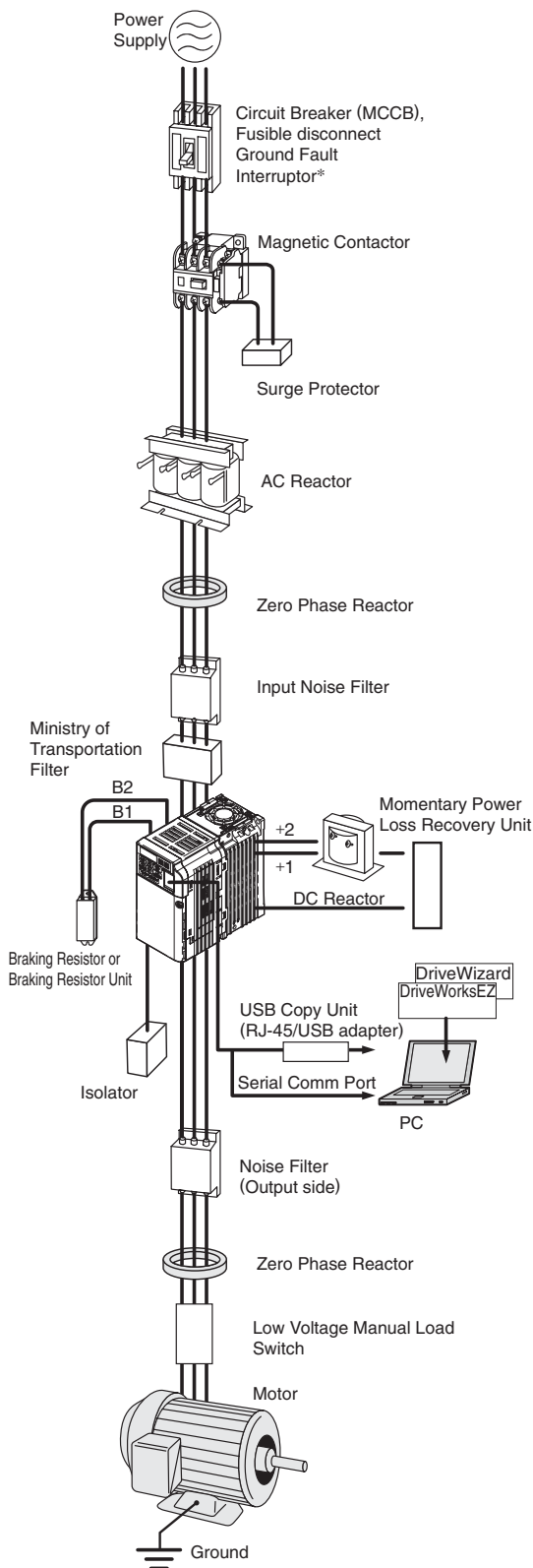

\*: Ground fault interruptor often apply to non-ground distribution system.

Name	Purpose	Model [maker]
Circuit Breaker	Line Breaker	Recommended: NF series by Mitsubishi Electric
Ground Fault Interruptor (GFI)	If using an GFI designed to counteract harmonic distortion in drives, make sure to use the interruptor with rated sensing current 30 mA or more per one drive. For GFI is not designed to counteract harmonic distortion, the GFI should be able to handle at least 200 mA or more. Be sure to also lower the carrier frequency or take other measures to protect components affected by harmonic distortion.	Recommended: NV series by Mitsubishi Electric EG, SG series by Fuji Electric
Magnetic Contactor	Interrupts the power supply to the drive.	Recommended: SC series by Fuji Electric
Surge Protector	Absorbs the voltage surge from switching of electro-magnetic contactors and control relays.	DCR2 series RFN series
DC Reactor	Used for harmonic current suppression and total power factor improvement.	UZDA series
AC Reactor	Should be used if the power supply is capacity is larger than 600 kVA.	UZBA series
Zero Phase Reactor	Reduces noise from the line that enters into the drive input power system. Place as close to the drive as is as possible. Can be used on both the input and output sides.	F6045GB by Hitachi Metals, Ltd.
Input Noise Filter	Reduce the noise emitted by the drive into the power supply system. Should be installed as close as possible to the drive.	LNFD series LNFB series
Output Noise Filter	Reduces noise originating from the output side wiring of the drive. Install the filter as close as possible to the drive.	LF series by NEC TOKIN Corporation
Isolator	Isolates the drive I/O signal, and is effective to reducing inductive noise.	DGP2 series
Braking Resistor	Used to shorten the deceleration time by dissipating regenerative energy through a resistor. (3% ED)	ERF-150WJ series
Dynamic Braking Resistor	Used to shorten the deceleration time by dissipating regenerative energy through a resistor. A thermal overload relay is built in. (10% ED)	LKEB series
24 VDC Power Supply Unit	Provides power supply for the control circuit and option boards.	Available soon
USB Copy Unit (RJ-45/USB compatible plug)	<ul style="list-style-type: none"> <li>• Adapter for connecting the drive to the USB port of a PC.</li> <li>• Can copy parameter settings to be later transferred to another drive.</li> </ul>	JVOP-181
Support Tools (DriveWizard) Cable	Connects the drive and a PC when using DriveWizard.	WV103
LCD Operator	<ul style="list-style-type: none"> <li>• LCD operator keypad used to control the drive.</li> <li>• Includes a Copy function for saving drive settings.</li> </ul>	Available soon
LCD Operator Extension Cable	Cable for connecting the LCD operator.	
Communication Interface Unit	CC-Link	SI-C3/V
	DeviceNet	Available soon
	PROFIBUS-DP	SI-P3/V
	CANopen	Available soon
	LONWORKS	Available soon

Name	Purpose	Model [maker]
Momentary Power Loss Recovery Unit	Ensures continued drive operation for a power loss of up to 2 s.	P0010 Type (200V class) P0020 Type (400V class)
Frequency Meter, Current Meter	Allows the user to set and monitor the frequency, current, and voltage using an external device.	DCF-6A
Frequency Potentiometer (2 k $\Omega$ )		RH000739
Frequency meter adjusting potentiometer (20 k $\Omega$ )		RH000850
Frequency Dial		CM-3S
Output Voltage Meter		SDF-12
NEMA 1 Kit	Turns an IP20 open-chassis design into a NEMA 1 compliant enclosure panel.	—
Heatsink External Mounting	Mechanical kit to install the drive with the heatsink out of the cabinet. Note: Current derating must be considered when this installation method is used.	Available soon
DIN Rail Attachment	Allows mounting the drive on DIN rail.	—
Screwless Terminal Board	Control terminal board with screw less terminals.	Available soon
Low Voltage Manual Load Switch	Prevents shock from the voltage created on the terminals board from a coasting synchronous motor.	Recommended: AICUT, LB series by AICHI ELECTRIC WORKS CO.,Ltd.

Note: Contact the manufacturer in question for availability and specifications of non-Yaskawa products.



## Application Notes

### Selection

#### ■ Installing a Reactor

An AC or DC reactor should be installed in the following conditions:

- to suppress harmonic currents.
- to suppress peak currents when power factor correction capacitors in the power supply network are switched.
- when the power supply capacity is above 600 kVA.
- when the drive is connected to the same power supply system with thyristor converters like DC drives.

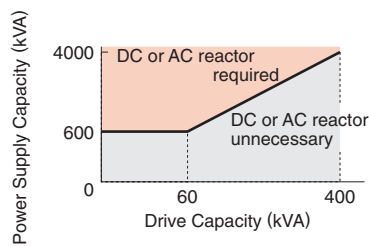

#### ■ Drive Capacity

When running a specialized motor or more than one motor in parallel from a single drive, the capacity of the drive should be larger than 1.1 times of the total motor rated current.

#### ■ Starting Torque

The overload rating for the drive determines the starting and accelerating characteristics of the motor. Expect lower torque than when running from line power. To get more starting torque, use a larger drive or increase both the motor and drive capacity.

#### ■ Emergency Stop

When the drive faults out, a protective circuit is activated and drive output is shut off. This, however, does not stop the motor immediately. Some type of mechanical brake may be needed if it is necessary to halt the motor faster than the Fast Stop function is able.

#### ■ Options

Terminals B1, B2, F, +1, +2, – are provided for connecting optional features for the drive designed by Yaskawa. Do not connect other equipment designed by other manufacturers.

### Repetitive Starting/Stopping

Cranes (Hoists), elevators, punching presses, and other such applications with frequent starts and stops often exceed 150% of their rated current values. Heat stress generated from repetitive high current can shorten the lifespan of the IGBTs. The expected lifespan for the IGBTs is about 8 million start and stop cycles with a 4 kHz carrier frequency and a 150% peak current.

Yaskawa recommends lowering the carrier frequency, particularly when audible noise is not a concern. The user can also choose to reduce the load, increase the acceleration and deceleration times, or switch to a larger drive. This will help keep peak current levels under 150%. Be sure to check the peak current levels when starting and stopping repeatedly during the initial test run, and make adjustments accordingly.

For crane-type applications taking the inching function in which the motor is quickly started and stopped, Yaskawa recommends the following to ensure motor torque levels and lower the drive:

- Select a large enough drive so that peak current levels remain below 150%.
- The drive should be one frame size larger than the motor.

### Installation

#### ■ Enclosure Panels

Keep the drive in a clean environment by either selecting an area free of airborne dust, lint, and oil mist, or install the drive in an enclosure panel. Be sure to leave the required space between the drives to provide for cooling, and that proper measures are taken so that the ambient temperature remains within allowable limits. Keep on flammable materials. If the drive must be used in an area where it is subjected to oil mist and excessive vibration, protective designs are available. Contact Yaskawa for details.

#### ■ Installation Direction

The drive should be installed upright as specified in the manual.

### Settings

- If using PM Open Loop Vector Control designed for permanent magnet motors, make sure that the proper motor code has been set to parameter E5-01 before performing a trial run.

#### ■ Upper Limits

Because the drive is capable of running the motor at up to 400 Hz, be sure to set the upper limit for the frequency to control the maximum speed. The default setting for the maximum output frequency is 60 Hz.

#### ■ DC Injection Braking

Motor overheat can result if there is too much current used during DC Injection Braking, or if the time for DC Injection Braking is too long.

#### ■ Acceleration/Deceleration Times

Acceleration and deceleration times are affected by how much torque the motor generates, the load torque,



and the inertia moment ( $GD^2/4$ ). Set a longer accel/decel time when the stall prevention operates during acceleration or deceleration. The accel/decel times are lengthened by the amount of time the Stall Prevention function is operating. For faster acceleration or deceleration, increase the capacities of the motor and drive.

## General Handling

### ■ Wiring Check

Never connect the power supply lines to output terminals U/T1, V/T2, or W/T3. Doing so will destroy the drive. Be sure to perform a final check of all sequence wiring and other connections before turning the power on. Make sure there are no shorts circuits on the control terminals (+V, AC, etc.), as this could damage the drive.

### ■ Magnetic Contactor Installation

Avoid switching a magnetic contactor on the power supply side more frequently than once every 30 minutes. Frequent switching can cause damage to the drive.

### ■ Inspection and Maintenance

Capacitors in the drive take time to discharge even after the power has been shut off. To prevent shock, wait until the charge LED has gone out before attempting any maintenance on the drive.

The heatsink can become quite hot during operation, and proper precautions should be taken to prevent burns. When replacing the cooling fan, shut off the power and wait at least 15 minutes to be sure that the heatsink has cooled down.

Even when the power has been shut off for a drive running a PM motor, voltage continues to be generated at the motor terminals while the motor coasts to stop. Take the precautions described below to prevent shock and injury:

- Applications where the machine can still rotate even though the drive has fully stopped should have a low-voltage manual load switch installed to the output side of the drive. (Yaskawa recommends the AICUT LB Series by AICHI Electric Works Co., Ltd.)
- Do not apply to a load that could potentially rotate the motor faster than the maximum allowable r/min even when the drive has been shut off.
- Wait at least one minute after opening the low voltage manual load switch on the output side before inspecting the drive or performing and maintenance.
- Do not open a close the low voltage manual load switch while the motor is running, as this can damage the drive.
- To close the low voltage manual load switch connected to a coasting motor, first turn on the power to the drive

and make sure that the drive has stopped.

### ■ Terminal Wiring

Use round ring terminals when wiring the drive in compliance with UL or cUL standards. Terminals should be tightened in accordance with manufacturer specifications.

### ■ Transporting the Drive

Never steam clean the drive.

During transport, keep the drive from coming into contact with salts, fluorine, bromine and other such harmful chemicals.

## ● Peripheral Devices

### ■ Installing an MCCB

Install an MCCB to the power supply side of the drive to protect internal circuitry. The type of MCCB needed depends on the power supply power factor (power supply voltage, output frequency, load characteristics, etc.).

Sometimes a fairly large MCCB may be required due to the affects of harmonic current on operating characteristics. Circuit breakers selected should be designed specifically for use with drives, and comply with standards to regulate harmonic distortion.

### ■ Magnetic Contactor for Input Power

Even when an MC is installed to protect the drive as power is restored following a momentary power loss, frequent MC use can damage other components. Avoid switching the MC more than once every 30 minutes. The MC will not be activated after a momentary power loss if using the operator keypad to run the drive. This is because the drive is unable to restart automatically when set for LOCAL. Although the drive can be stopped by using an MC installed on the power supply side, the drive can not stop the motor controlled. It will coast to stop. If a braking resistor or dynamic braking unit has been installed, be sure to set up a sequence that opens the MC with a thermal protector switch connected to the braking resistor device.

### ■ Magnetic Contactor for Motor

As a general principle, the user should avoid opening and closing the magnetic contactor between the motor and the drive during run. Doing so can cause high peak currents and over current faults. If magnetic contactors are used to bypass the drive by connecting the motor to the power supply directly, make sure to close the bypass not before the drive is stopped and fully disconnected from the motor. If the motor start running even while coasting, select the speed search functions.



Set up delayed release when using a magnetic contactor to handle momentary power loss.

## ■ Motor Thermal Over Load Relay Installation

The drive comes with built in electrothermal protection to prevent damage from overheat. If running several motors from the same drive or if using a multi-pole motor, a thermal relay (THR) should be connected between the drive and each motor. Disable the motor protection selection parameter (L1-01 = 0), and set the thermal relay or thermal protector value in accordance with the data listed on the motor nameplate when running at 50 Hz, and 1.1 times the value listed on the motor nameplate when running at 60 Hz.

## ■ Improving the Power Factor

Installing a DC or AC reactor to the input side of the drive can help improve the power factor. Refrain from using a capacitor or surge absorber on the output side as a way of improving the power factor, as harmonic contents on the output side can lead to damage from overheat. This can also lead to problems with overcurrent.

## ■ Radio Frequency Interference

Drive output contains harmonic contents that can affect the performance of surrounding electronic instruments such as an AM radio. These problems can be prevented by installing a noise filter, as well as by using a properly grounded metal conduit to separate wiring between the drive and motor.

## ■ Wire Gauges and Wiring Distance

Motor torque can suffer as a result of voltage loss across a long cable running between the drive and motor, especially when there is low frequency output. Make sure that a large enough wire gauge is used. The optional LCD operator requires a proprietary cable to connect to the drive. If an analog signal is used to operate the drive via the input terminals, make sure that the wire between the analog operator and the drive is no longer than 50 m, and that it is properly separated from the main circuit wiring. Use reinforced circuitry (main circuit and relay sequence circuitry) to prevent inductance from surrounding devices. To run the drive with a speed potentiometer via the external terminals, use twisted shielded pair cables and ground the shield.

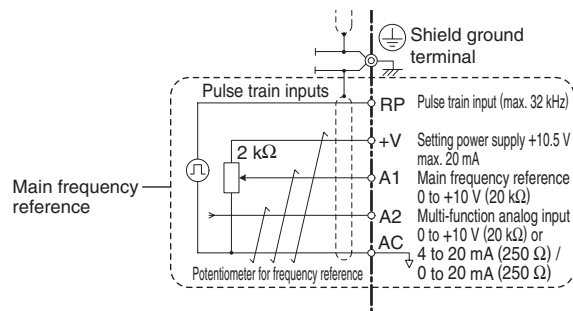

## ■ Counteracting Noise

Because V1000 is designed with PWM control, a low carrier frequency tends to create more motor flux noise than using a higher carrier frequency. Keep the following point in mind when considering how to reduce motor noise:

- Lowering the carrier frequency minimizes the effects of noise.
- A line noise filter can be effective in reducing the affects on AM radio frequencies and poor sensor performance. See "Options and Peripheral Devices" on page 23.
- Make sure the distance between signal and power lines is at least 10 cm, (up to 30 cm is preferable) and use twisted pair cable to prevent induction noise from the drive power lines.

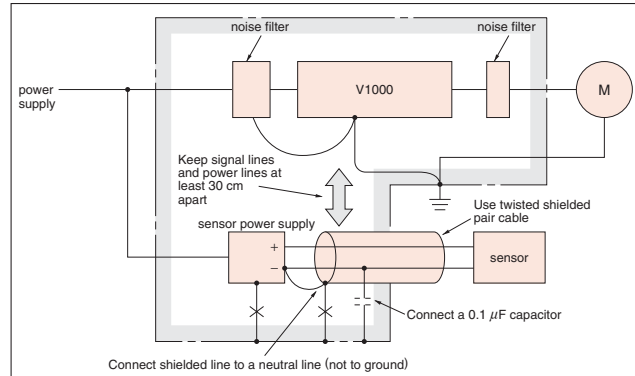

<Provided by JEMA>

## ■ Leakage Current

Harmonic leakage current passes through stray capacitance that exists between the power lines to the drive, ground, and the motor lines. Consider using the following peripheral devices to prevent problems with leakage current.

	Problem	Solution
Ground Leakage Current	MCCB is mistakenly triggered	<ul style="list-style-type: none"> <li>• Lower the carrier frequency set to parameter C6-02.</li> <li>• Try using a component designed to minimize harmonic distortion for the MCCB such as the NV series by Mitsubishi.</li> </ul>
Current Leakage Between Lines	Thermal relay connected to the external terminals is mistakenly triggered by harmonics in the leakage current	<ul style="list-style-type: none"> <li>• Lower the carrier frequency set to parameter C6-02.</li> <li>• Use the drive built in thermal motor protection function.</li> </ul>

### Setting the Carrier Frequency Relative to Wiring Distance

Wiring Distance	50 m or less	100 m or less	100 m or more
C6-02: Carrier Frequency Selection	Any setting possible	1, 2, 7, or Auto (5 kHz or less)	1, 7, or Auto (2 kHz or less)

When a single drive is used to run multiple motors, the length of the motor cable should be calculated as the total distance between the drive and each motor. A lower carrier should be used if the cable running between the motor and drive is relatively long when using PM Open Loop Vector, preferably as low as 2 kHz. If the motor cable is longer than 100 m, switch over to V/f Control with IM instead.

## Notes on Motor Operation

### Using a Standard Motor

#### Low Speed Range

There is a greater amount of loss when operating a motor using an drive than when running directly from line power. With a drive, the motor can become quite hot due to the poor ability to cool the motor at low speeds. The load torque should reduced accordingly at low speeds. The figure above shows the allowable load characteristics for a Yaskawa standard motor. A motor designed specifically for operation with a drive should be used when 100% continuous torque is needed at low speeds.

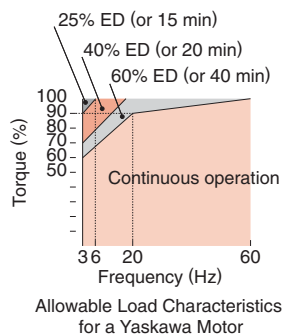

#### Insulation Tolerance

Thoughts should be given to voltage tolerance levels and insulation in applications with an input voltage of over 440 V or particularly long wiring distances. Contact Yaskawa for consultation.

#### High Speed Operation

Problems may occur with the motor bearings and dynamic balance in applications operating at over 60 Hz. Contact Yaskawa for consultation.

#### Torque Characteristics

Torque characteristics differ when operating directly from line power. The user should have a full understanding of the load torque characteristics for the application.

#### Vibration and Shock

V1000 lets the user choose between high carrier PWM control and low carrier PWM. Selecting high carrier PWM can help reduce motor oscillation. Keep the following points in mind when using high carrier PWM:

##### (1) Resonance

Take particular caution when using a variable speed drive for an application that is conventionally run from line power at a constant speed. Shock-absorbing rubber should be installed around the base of the motor and the Jump Frequency selection should be enabled to prevent resonance.

##### (2) Any imperfection on a rotating body increases with speed

Caution should be taken when operating above the motor rated speed.

#### Audible Noise

Noise created during run varies by the carrier frequency setting. Using a high carrier frequency creates about as much noise as running from line power. Operating above the rated r/min (i.e., above 60 Hz), however, can create a piercing squeal.

### Using a Synchronous Motor

Contact Yaskawa if you plan to use any other synchronous motor not endorsed by Yaskawa.

Synchronous motors cannot be started directly from line power. Applications that requiring line power to start should use an induction motor with the drive.

A single drive is not capable of running multiple synchronous motors at the same time. Use a standard induction motor for such setups.

At start, the motor may rotate in reverse as much as 1/8 of a turn.

Uses derated torque of 50% less than starting torque. Set up the motor with the drive after verifying the starting torque, allowable load characteristics, impact load tolerance, and speed control range.

Contact Yaskawa if you plan to use a motor that does not fall within these specifications.

Even with a braking resistor, braking torque is less than 100% when running between 20% to 100% speed, and falls to less than half the braking torque when running at less than 20% speed.



- There is no torque control available, and torque limits cannot be set. Consequently, synchronous motors are not appropriate for applications that operate at low speeds (less than 10% of the rated speed) or experience sudden changes in speed. Such applications are better suited for induction motors or servo drives.
- The allowable load inertia moment is 50 times less than the motor inertia moment. Contact Yaskawa concerning applications with a larger inertia moment.
- When using a holding brake, release the brake prior to starting the motor. Failure to set the proper timing can result in speed loss. Not for use with conveyor, transport, or hoist type applications.
- To restart a coasting motor rotating at over 120 Hz, use the Short Circuit Braking\* function to first bring the motor to a stop. Short Circuit Braking requires a special braking resistor. Contact Yaskawa for details.  
Speed Search can be used to restart a coasting motor rotating slower than 120 Hz. If the motor cable is relatively long, however, the motor should instead be stopped using Short Circuit Braking and then restarted.

\*: Short Circuit Braking creates a short-circuit in the motor windings to forcibly stop a coasting motor.

## Applications with Specialized Motors

- **Multi-pole Motor**  
Because the rated current will differ from a standard motor, be sure to check the maximum current when selecting a drive. Always stop the motor before switching between the number of motor poles. If a regen overvoltage fault occurs or if overcurrent protection is triggered, the motor will coast to stop.
- **Submersible Motor**  
Because motor rated current is greater than a standard motor, select the drive capacity accordingly. Be sure to use a large enough motor cable to avoid decreasing the maximum torque level on account of voltage drop caused by a long motor cable.
- **Explosion-proof Motor**  
Both the motor and drive need to be tested together to be certified as explosion-proof. The drive is not for explosion proof areas.
- **Geared Motor**  
Continuous operation specifications differ by the manufacturer of the lubricant. There is concern with

burning out the gears if operating continuously at low speeds with an oil lubricant. Consult with the manufacturer for applications that require speeds greater than the rated speed range of the motor or gear box.

- **Single-phase Motor**  
Variable speed drives are not designed for operating single phase motors. Using a capacitor to start the motor causes excessive current to flow into the capacitors, potentially causing damage. A split-phase start or a repulsion start can end up burning out the starting coils because the internal centrifugal switch is not activated. The drive can only be used with three-phase motors.
- **Uras Vibrator**  
Uras vibrator is a vibration motor that gets power from centrifugal force by rotating unbalance weights on both ends of the shaft. Make the following considerations when selecting a drive for use with an Uras vibrator:
  - (1) Uras vibrator should be used with the drive rated frequency
  - (2) Use V/f Control
  - (3) Increase the acceleration time five to fifteen times longer than would normally be used due to the high amount of load inertia of a Uras vibrator  
Note: Contact Yaskawa for applications that require an acceleration time of less than 5 s.
  - (4) Drive may have trouble starting due to undertorque that results from erratic torque (static friction torque at start)

- **Motor with Brake**  
Caution should be taken when using a drive to operate a motor with a built-in holding brake. If the brake is connected to the output side of the drive, it may not release at start due to low voltage levels. A separate power supply should be installed for the motor brake. Motors with a built-in brake tend to generate a fair amount of noise when running at low speeds.

## Power Driven Machinery (decelerators, belts, chains, etc.)

Operating continuous at low speeds wears on the lubricating material used in gear box type systems to acceleration and decelerate power driven machinery. Caution should also be taken when operating at speeds above the rated machine speed due to noise and shortened performance life that can result.



# Service Network



Region	Service Area	Service Location	Service Agency	Telephone/Fax
North America	U.S.A	Chicago (HQ) Los Angeles New Jersey Boston San Francisco, Ohio North Carolina	① YASKAWA ELECTRIC AMERICA INC.	Headquarters ☎ +1-847-887-7303 FAX +1-847-887-7070
	Mexico	Mexico City	② PILLAR MEXICANA. S.A. DE C.V.	☎ +52-5593-28-69 FAX +52-5651-55-73
South America	South America	Sao Paulo	③ YASKAWA ELÉCTRICO DO BRASIL LTDA.	☎ +55-11-5071-2552 FAX +55-11-5581-8795
	Colombia	Santafe De Bogota	④ VARIADORES LTD.A.	☎ +57-91-635-7460 FAX +57-91-611-3872
Europe	All of Europe and South Africa	Frankfurt	⑤ YASKAWA ELECTRIC EUROPE GmbH	☎ +49-6196-569-300 FAX +49-6196-569-398
			⑥ YASKAWA ENGINEERING EUROPE GmbH	☎ +49-6196-569-520 FAX +49-6196-888-598
Asia	Japan	Tokyo, and elsewhere	⑦ YASKAWA ELECTRIC CORPORATION (Manufacturing, sales) ⑧ YASKAWA ELECTRIC ENGINEERING CORPORATION (After-sales service)	See the back cover.
	South Korea	Seoul	⑨ YASKAWA ELECTRIC KOREA CORPORATION	☎ +82-2-784-7844 FAX +82-2-784-8495
			⑩ YASKAWA ENGINEERING KOREA Co.	☎ +82-2-3775-0337 FAX +82-2-3775-0338
			⑪ Rockwell Samsung Automation Co., Ltd.	☎ +82-331-200-2981 FAX +82-331-200-2970
	China	Beijing, Guangzhou, Shanghai	⑫ YASKAWA ELECTRIC (SHANGHAI) Co., Ltd.	☎ +86-21-5385-2200 FAX +86-21-5385-3299
			⑬ Shanghai Yaskawa-Tongji M&E Co.,Ltd.	☎ +86-21-6553-6060 FAX +86-21-5588-1190
	Taiwan	Taipei	⑭ YASKAWA ELECTRIC TAIWAN Co.	☎ +886-2-2502-5003 FAX +886-2-2505-1280
	Singapore	Singapore	⑮ YASKAWA ELECTRIC (SINGAPORE) Pte. Ltd.	☎ +65-6282-3003 FAX +65-6289-3003
			⑯ YASKAWA ENGINEERING ASIA-PACIFIC Pte. Ltd.	☎ +65-6282-1601 FAX +65-6282-3668
	Thailand	Bangkok	⑰ YASKAWA ELECTRIC (THAILAND) Co., Ltd.	☎ +66-2-693-2200 FAX +66-2-693-2204
India	Mumbai	⑱ LARSEN & TOUBRO LIMITED	Headquarters ☎ +91-22-7683511 (662) FAX +91-22-7683525	
Oceania	Australia	Sydney (HQ) Melbourne	⑲ ROBOTIC AUTOMATION Pty. Ltd.	Headquarters ☎ +61-2-9748-3788 FAX +61-2-9748-3817

# V1000

---

**IRUMA BUSINESS CENTER (SOLUTION CENTER)**

480, Kamifujisawa, Iruma, Saitama 358-8555, Japan  
Phone 81-4-2962-5696 Fax 81-4-2962-6138

**YASKAWA ELECTRIC AMERICA, INC.**

2121 Norman Drive South, Waukegan, IL 60085, U.S.A.  
Phone 1-847-887-7000 Fax 1-847-887-7370

**YASKAWA ELÉTRICO DO BRASIL LTDA.**

Avenida Fagundes Filho, 620 Bairro Saude-Sao Paulo-SP, Brazil CEP: 04304-000  
Phone 55-11-5071-2552 Fax 55-11-5581-8795

**YASKAWA ELECTRIC EUROPE GmbH**

Am Kronberger Hang 2, 65824 Schwalbach, Germany  
Phone 49-6196-569-300 Fax 49-6196-569-312

**YASKAWA ELECTRIC UK LTD.**

1 Hunt Hill Orchardton Woods Cumbernauld, G68 9LF, United Kingdom  
Phone 44-1236-735000 Fax 44-1236-458182

**YASKAWA ELECTRIC KOREA CORPORATION**

7F, Doore Bldg. 24, Yeoido-dong, Youngdungpo-Ku, Seoul 150-877, Korea  
Phone 82-2-784-7844 Fax 82-2-784-8495

**YASKAWA ELECTRIC (SINGAPORE) PTE. LTD.**

151 Lorong Chuan, #04-01, New Tech Park 556741, Singapore  
Phone 65-6282-3003 Fax 65-6289-3003

**YASKAWA ELECTRIC (SHANGHAI) CO., LTD.**

No.18 Xizang Zhong Road, Room 1702-1707, Harbour Ring Plaza Shanghai 200001, China  
Phone 86-21-5385-2200 Fax 86-21-5385-3299

**YASKAWA ELECTRIC (SHANGHAI) CO., LTD. BEIJING OFFICE**

Room 1011A, Tower W3 Oriental Plaza, No.1 East Chang An Ave.,  
Dong Cheng District, Beijing 100738, China  
Phone 86-10-8518-4086 Fax 86-10-8518-4082

**YASKAWA ELECTRIC TAIWAN CORPORATION**

9F, 16, Nanking E. Rd., Sec. 3, Taipei, Taiwan  
Phone 886-2-2502-5003 Fax 886-2-2505-1280



YASKAWA ELECTRIC CORPORATION

YASKAWA

In the event that the end user of this product is to be the military and said product is to be employed in any weapons systems or the manufacture thereof, the export will fall under the relevant regulations as stipulated in the Foreign Exchange and Foreign Trade Regulations. Therefore, be sure to follow all procedures and submit all relevant documentation according to any and all rules, regulations and laws that may apply.



Specifications are subject to change without notice for ongoing product modifications and improvements.

© 2007 YASKAWA ELECTRIC CORPORATION. All rights reserved.

LITERATURE NO. KAEP C710606 08A

Printed in Japan August 2007 07-8

07-7 ©

  Printed on 100% recycled paper with soybean oil ink.