

## FTABLE OF COTENTS

<b>PROCLAMATION.....</b>	<b>II</b>
<b>ATTENTIONS .....</b>	<b>III</b>
<b>CHAPTER 1 PRODUCT INTRODUCTION .....</b>	<b>1</b>
1.1. PRODUCT APPEARANCE .....	1
1.2. MODEL DESCRIPTION.....	7
1.3. PRODUCT SPECIFICATIONS .....	8
<b>CHAPTER 2 COMMUNICATION PORTS.....</b>	<b>13</b>
2.1. CONFIGURATIONS .....	13
2.1.1. Functions.....	13
2.1.2. Pin Definition.....	14
2.1.3. Communications Support.....	16
2.1.4. PLC Connections .....	18
2.2. HMI COMMUNICATIONS SETUP .....	81
2.3. MANY TO ONE .....	82
<b>CHAPTER 3 SYSTEM CONFIGURATIONS .....</b>	<b>85</b>
3.1. SETTING DESCRIPTION .....	85
3.2. SYSTEM SETUP.....	87
3.3. POWER SETUP .....	88
3.4. COMMUNICATION SETUP.....	89
3.5. LANGUAGE.....	92
3.6. PASSWORD EDIT.....	93
3.7. INTERFACE TEST .....	94
3.8. DATA TRANSFER.....	96
3.9. SPECIAL FUNCTION .....	97
3.10. RUN .....	99
3.11. SYSTEM INFORMATION.....	99
3.12. RESUME .....	100
<b>APPENDIX A: ADDITIONAL DESCRIPTION.....</b>	<b>101</b>
A.1.REMOTE MONITORING .....	101
A.1.1.Local network connection.....	101
A.1.2. Internet connection.....	106
A.2. FTP SERVER READS RECORD FILE.....	110
A.3. COMMUNICATION ERROR WARNING MESSAGE.....	112
A.4. HOW TO COPE WITH THE NOISE INTERFERENCE.....	113

## Proclamation

Thank you for purchasing Shihlin Electric's Human Machine Interface (HMI).

Please follow the order of the chapters to read the instructions and operate the device.

- A. If users apply the HMI to a non-industrial controlled product, Shihlin Electric shall bear no responsibility on any damage whatsoever.
- B. The software will be updated irregularly to add in new features. If users find the functions are somewhat different from the manual contents, please go to Shihlin Electric's website to download the latest information.
- C. Even if the information or the HMI implies intangible or intellectual property rights of Shihlin Electric or third parties, Shihlin Electric does not guarantee or grant any user and/or third parties the use of the HMI.
- D. Although this manual has been proofread many times, imperfection is inevitable. We look forward to your opinions. If you have any questions or suggestions, please contact us and we'll very appreciate it.



## Attentions

---

To properly and safely operate this device, please read this manual and relevant guide carefully to fully understand the features of the device and correct way of using it.

- A. Touch panel switch should not be used under ON / OFF wire abnormalities that may result in personnel injury or equipment damage, even lead to serious incidents.
- B. Output signal may lead to serious incidents, thus must be equipped with monitoring circuits, such as limiters; and the system must be designed to have reset mechanism, so that conduction can be controlled by means other than the HMI, to prevent incidents resulting from malfunctions or failure of the touch panel switch.
- C. The control switch of the HMI should not be used as an emergency stop switch for a device. To the health and safety concerns, the labor requires all industrial machinery system must be equipped with a mechanical, manually operated emergency stop switch; and for other types of systems, similar mechanical switches must also be provided to ensure safe operations.
- D. Please do not shut down you computer, close the editor software or switch off the HMI, when a program is being edited or a HMI project is being transmitted. Doing so may crash the project program.
- E. Do not use a document editing software or any other types of editing software to modify the project structure of this product. Doing so may crash the project program and result in disabled execution.
- F. Do not remove the external memory module when the HMI is running. Doing so may corrupt the files inside the external memory device.

This manual is divided into three sections. Screen layout illustrations are provided, allowing you to quickly learn the functions of the editing screens after reading the manual.



# Chapter 1 Product Introduction

## 1.1. Product Appearance

EC210-CT11/EC208-CT11/EC207-CT11

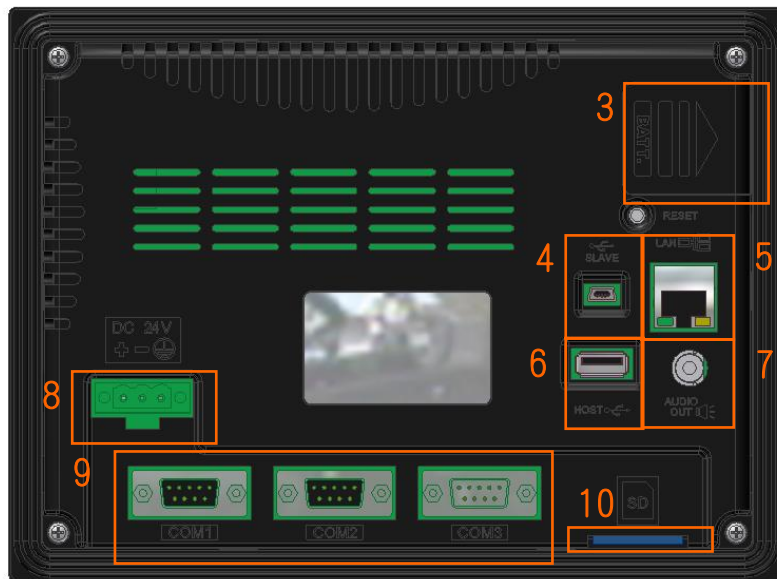

NO	Name	NO	Name	NO	Name
1	Display screen	5	Ethernet interface	9	COM port
2	LED	6	USB Host interface	10	SD card interface
3	Battery Holder	7	Sound interface		
4	USB Slave interface	8	Power terminal		

EC210-CT00/EC208-CT00/EC207-CT00

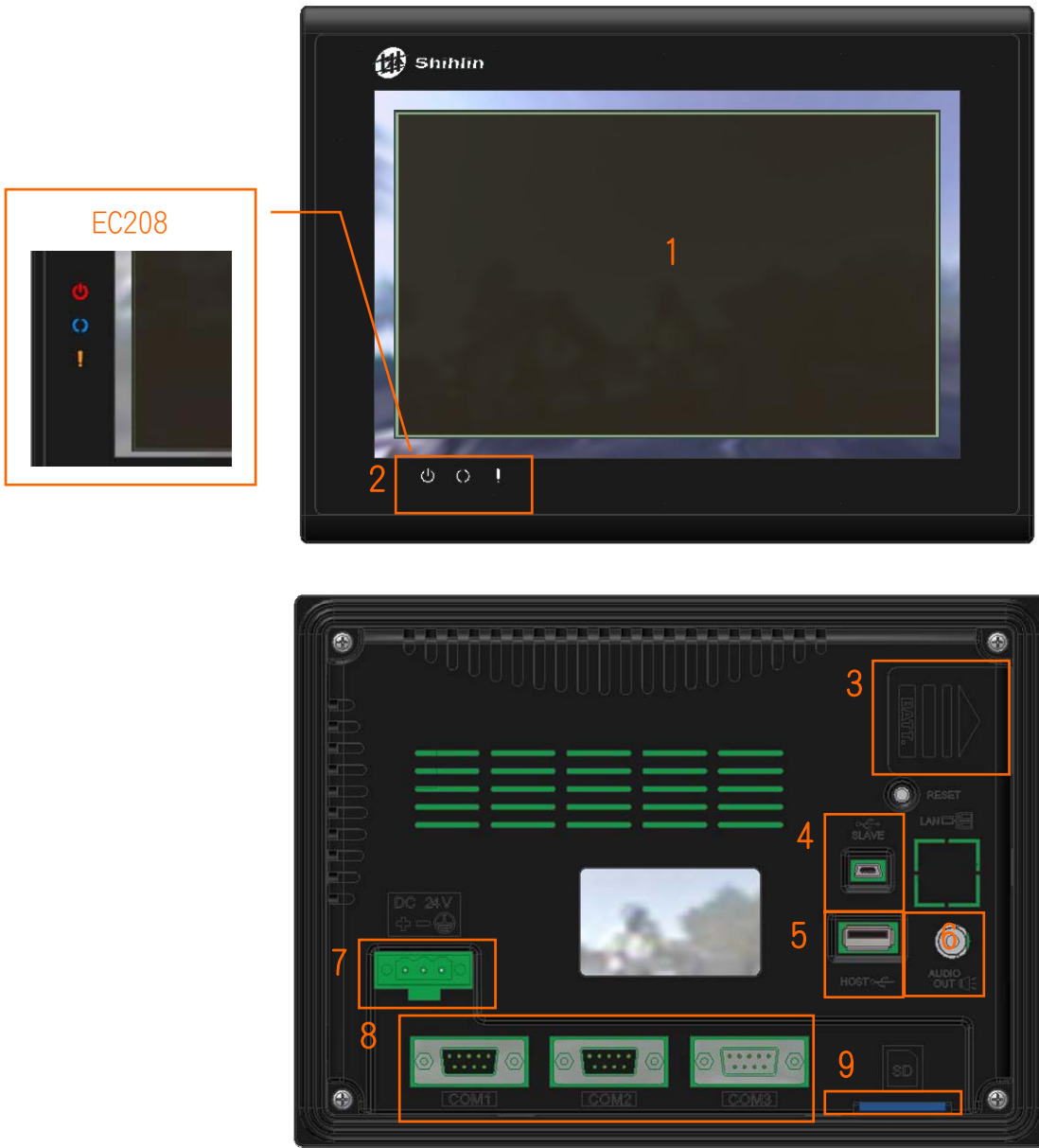

NO	Name	NO	Name	NO	Name
1	Display screen	5	USB Host interface	9	SD card interface
2	LED	6	Sound interface		
3	Battery Holder	7	Power terminal		
4	USB Slave interface	8	COM port		

EC207-CT0A

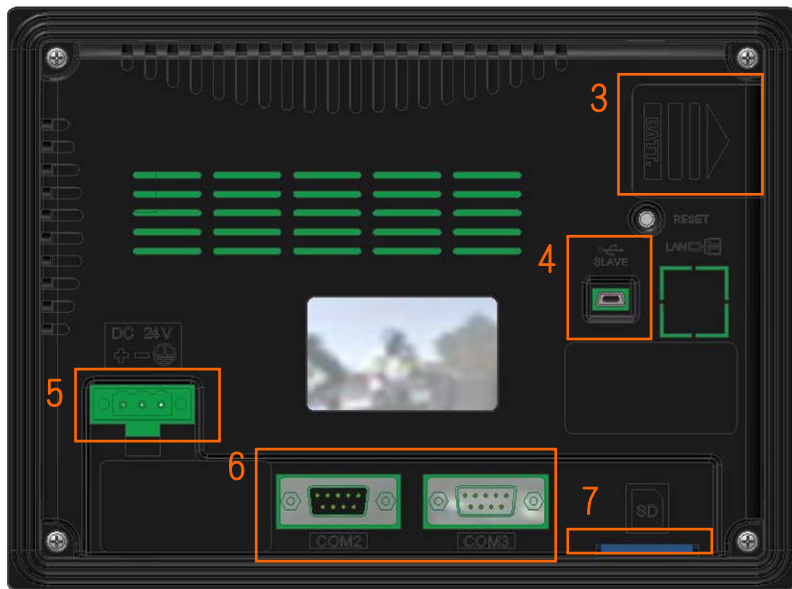

NO	Name	NO	Name
1	Display screen	5	Power terminal
2	LED	6	COM port
3	Battery Holder	7	SD card interface
4	USB Slave interface		

# EC205-CT0A

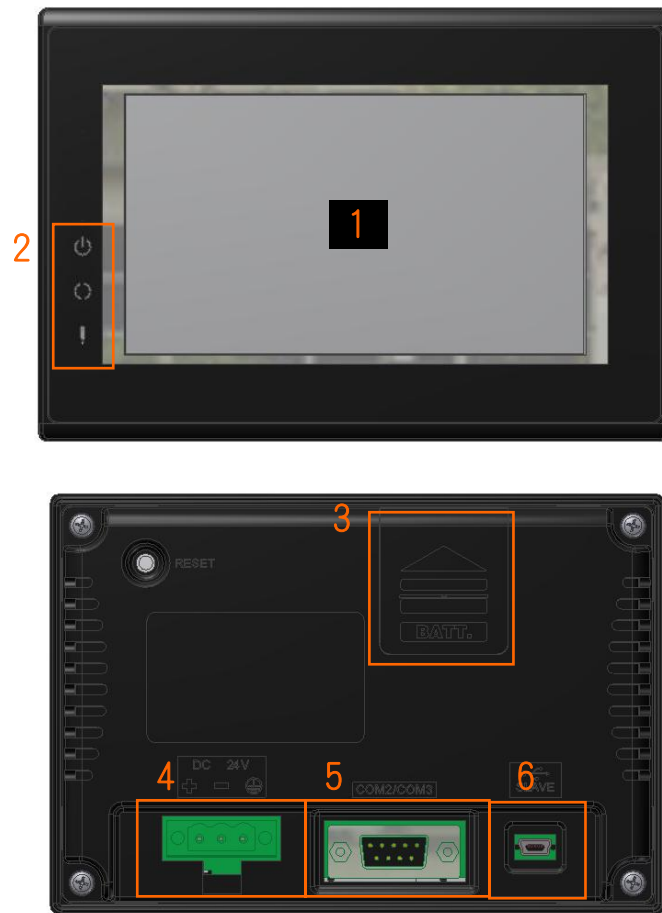

NO	Name	NO	Name
1	Display screen	5	COM port
2	LED	6	USB Slave interface
3	Battery Holder		
4	Power terminal		

EC207-CT1S/EC207-CT0S

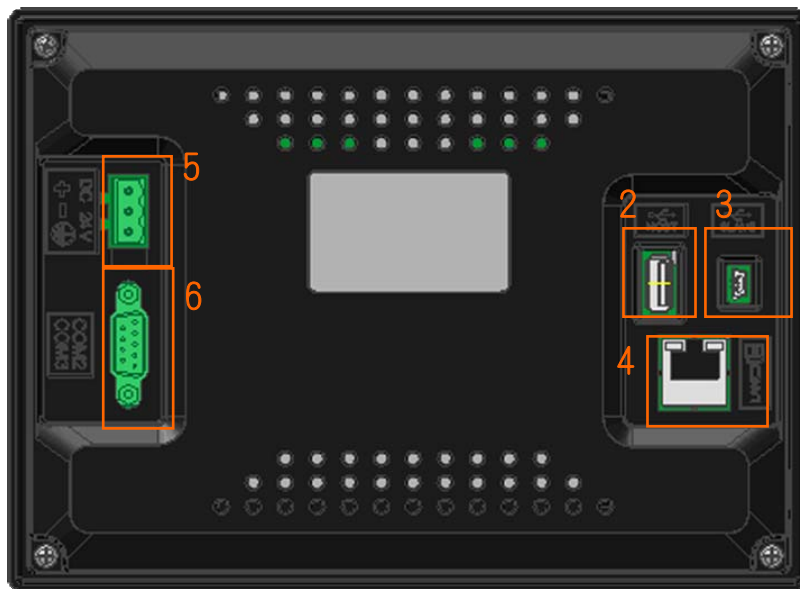

NO	Name	NO	Name
1	Display screen	5	Power terminal
2	USB Host interface	6	COM port
3	USB Slave interface		
4	Ethernet interface		



- EC207-CT0S model does not support Ethernet port.



Part names description :

Name	Description	
Display screen	Displays the Utility and the user creation screen.	
LED	⏻	: When power is turned on.
	⦿	: Screen run.
	⦿ flicker	: When the low battery or no battery, the light stops flashing after 1 minute.
	! flicker	: Communication Error.
Battery Holde	Houses the Battery.	
USB Slave interface	For connecting a PC.	
Ethernet interface	The Ethernet transmission interface.	
Sound interface	Sound output , support for Sound play.	
USB Host interface	For installing USB storage Device.	
Power terminal	DC24V	
COM port	COM1	RS232C / RS422 / RS485
	COM2	Low level Model,Ethernet Low level Model,and Cost-Effective Models : RS422 / RS485 Standard Models and Ethernet Multifunctional Models : RS232C / RS422 / RS485
	COM3	RS232C
SD card interface	For installing SD card.	

## 1.2. Model Description

The models and corresponding features of Shihlin Electric's HMI are listed in the following Table 1-2-1.

Table 1-2-1 Mode Codes (a) Model Description (b) Corresponding Types

EC2 XX - CT XX  
 (1) (2) (3) (4)

Name	Description
(1)Model Name	EC2 : EC200 Series
(2)Panel Size	05 : 4.7 inches 07 : 7 inches 08 : 8 inches 10 : 10.2 inches
(3)Monitor Type	C : Color T : TFT LCD
(4)Model Type	0S : Low level Model 1S : Ethernet Low level Model 0A : Cost-Effective Model 00 : Basic Model 11 : Ethernet Model

(a)

Model Support	EC205-CT0A Cost-Effective Model	EC207-CT0S Low level Model	EC207-CT1S Ethernet Low level Model	EC207-CT0A Cost-Effective Model	00 Basic Model	11 Ethernet Model
COM1	×	×	×	×	○	○
COM2	○	○	○	○	○	○
COM3	○	○	○	○	○	○
USB	○	○	○	○	○	○
USB Host	×	○	○	×	○	○
Sound	×	×	×	×	○	○
Ethernet	×	×	○	×	×	○
SD Card	×	×	×	○	○	○

(b)

### 1.3. Product Specifications

Table 1-3-1 Hardware Specifications

Parameter		Model		EC205-CT				EC207-CT							
		0A		0S		1S		0A		00		11			
Processor		32Bit RISC 400MHz													
Color Display		over 65,000 colors													
Monitor		TFT LCD													
Display Specifications	Screen Size(inches)	4.7				7									
	Resolution(DPI)	480×272				800×480									
	Brightness(cd/m2)	350				250				300					
	Contrast	500:1				500:1									
	Viewing Angel Range	60/70/70/70 (T/B/R/L)				50/70/70/70 (T/B/R/L)									
	Backlight	LED													
	Backlight Life	Under room temperature of 25°C , the half-life is greater than 30,000 hours.													
	Touch Panel Specifications	Touch Panel	4-wire resistive												
Touch Resolution		Over 2mm													
Life		Over a million times													
Hardness of Surface		4H													
Battery Life		Two years from manufacturing date													
Communication Ports	Serial Ports	COM1	None						RS-232/422/485						
		COM2	RS-422/485						RS-232/422/485						
		COM3	RS-232												
	Ethernet	Ethernet		None		None		10/100MB		None		None		10/100MB	
		USB	Host	None		USB1.1 x 1		None		USB1.1 x 1					
Client	USB2.0 x 1														
Ethernet		None						Yes							
Memory	Internal	ROM	Nand flash 64MB												
		SDRAM	64MB DDR2												
		Backup SRAM	128KB												
	External Interface		None						SD Card (support up to 16G)						

Table 1-3-1 Hardware Specifications (continued)

Parameters		Model	EC207-CT			
		EC205-CT	0S	1S	0A	00
Environment Specifications	Operating Ambient Temp.	0~45°C (avoid freezing)				
	Storage Ambient Temp.	-20~60°C (avoid freezing)				
	Operating Ambient Humidity	10%~85%RH (non-condensing environment)				
	Environmental Tolerance	Non-corrosive, non-conductive environment				
	Vibration Resistance	IEC61131-2 Compliant , Vibration Frequency : 10~150Hz , Acceleration : 9.8m/s <sup>2</sup> (1.0G) , X , Y , Z directions, each 12 times				
	Noise Resistance	In compliance with IEC 61000-6-2 : 2001				
Rated Voltage		24VDC±15%				
Installation Conditions	Water Resistance	Front Cover IP65 (dust and drip-proof design)				
	Cooling Method	Natural Air Cooling				
	Exterior Dimensions W×H×D(mm)	143x98.1x40.6	208x154x40.6			
	Hole-cutting Size (mm)	139x94.1	192x138			
	Weight (kg)	≒0.29	≒0.54	≒0.85		
Certification Specification		CE、FCC				

Table 1-3-1 Hardware Specifications (continued)

Parameter		Model		EC208-CT		EC210-CT	
		00	11	00	11		
Processor		32Bit RISC 400MHz					
Display Specifications	Color Display	over 65,000 colors					
	Monitor	TFT LCD					
	Screen Size(inches)	8			10.2		
	Resolution(DPI)	800×600			800×480		
	Brightness(cd/m2)	250			350		
	Contrast	500:1			300:1		
	Viewing Angel Range	50/70/70/70 (T/B/R/L)			45/65/65/65 (T/B/R/L)		
	Backlight	LED					
	Backlight Life	Under room temperature of 25°C , the half-life is greater than 30,000 hours.					
Touch Panel Specifications	Touch Panel	4-wire resistive					
	Touch Resolution	Over 2mm					
	Life	Over a million times					
	Hardness of Surface	4H					
Battery Life		Two years from manufacturing date					
Communication Ports	Serial Ports	COM1	RS-232/422/485				
		COM2	RS-232/422/485				
		COM3	RS-232				
	Ethernet	None	10/100MB	None	10/100MB		
	USB	Host	USB1.1 x 1				
Client		USB2.0 x 1					
Sound Interface		Yes					
Memory	Internal	ROM	Nand flash 64MB				
		SDRAM	64MB DDR2				
		Backup SRAM	128KB				
	External Interface	SD Card (support up to 16G)					

Table 1-3-1 Hardware Specifications (continued)

Model Parameters		EC208-CT		EC210-CT	
		00	11	00	11
Environment Specifications	Operating Ambient Temp.	0~45°C (avoid freezing)			
	Storage Ambient Temp.	-20~60°C (avoid freezing)			
	Operating Ambient Humidity	10%~85%RH (non-condensing environment)			
	Environmental Tolerance	Non-corrosive, non-conductive environment			
	Vibration Resistance	IEC61131-2 Compliant , Vibration Frequency : 10~150Hz , Acceleration : 9.8m/s <sup>2</sup> (1.0G) , X , Y , Z directions, each 12 times			
	Noise Resistance	In compliance with IEC 61000-6-2 : 2001			
Rated Voltage		24VDC±15%			
Installation Conditions	Water Resistance	Front Cover IP65 (dust and drip-proof design)			
	Cooling Method	Natural Air Cooling			
	Exterior Dimensions W×H×D(mm)	226x173x42.1		271x213x42.1	
	Hole-cutting Size (mm)	218x165		259 x 201	
	Weight (kg)	≐1.04		≐1.4	
Certification Specification		CE , FCC			



- This is a Class-A information product, which can cause radio frequency interference when used in a living environment. Under such a circumstance, take appropriate measures.

## 1.4. Wiring Description

Use the included power supply terminal. Loosen the screws of the power supply terminal, and then plug the power cord into the power supply terminal in accordance with the instructions shown on the power input on the back of the HMI. Use a straight screwdriver to tighten the screws of the power terminal, and finally plug the power supply terminal into the power input of the HMI. This is shown in Figure 1-5-1.

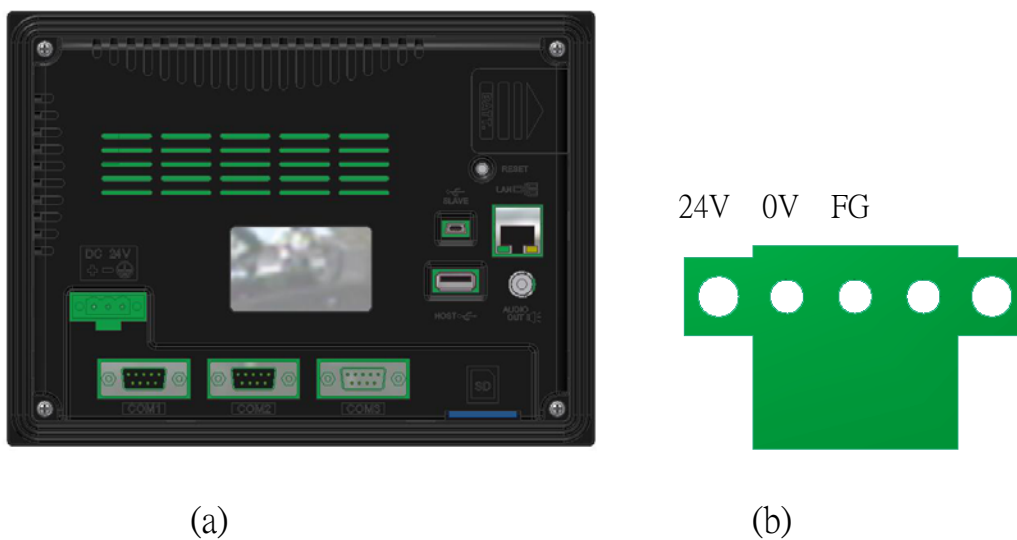

Fig. 1-5-1 Power Supply Wiring (a) Rear View (b) Power Supply Terminal



- Before plugging or un-plugging the power supply terminal, be sure to cut off the power source first to avoid possible damage to the communication electronics of the HMI.
- Users are advised to add Core on the input end of the power cord.



## Chapter 2 Communication Ports

---

### 2.1. Configurations

#### 2.1.1. Functions

Shihlin Electric's HMI series provides multiple communication ports, whose mechanisms are described in the following Table 2-1-1.

Table 2-1-1 Functions of Communication Ports

Mechanism	Description
Data Transmission	Able to transmit screen data via Ethernet and USB, and provide By Pass functions to transmit programs to PLC via the HMI's COM port.
Multiple Communication Ports	COM1/COM2/COM3、USB and Ethernet
Multi-brands Support	Support multiple brands of PLC models, Shihlin inverter, thermostat, and provide MODBUS communication.

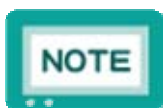

- When the MODBUS communication is selected, it can connect up to 31 units, and the station numbers are set to 1~31.



## 2.1.2. Pin Definition

COM port diagram is shown in the following Figure 4-1-2. COM1/COM2 ports are 9-Pin female connectors, and COM3 port is a 9-Pin male connector. The pin definitions are listed in the following Table in 2-1-3.

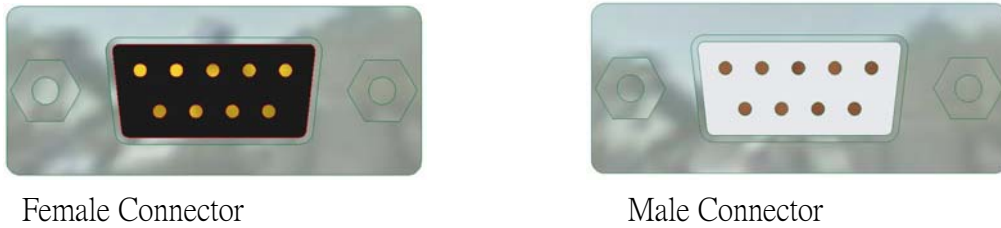
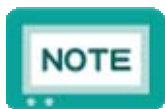

Fig. 2-1-2 Communication Port Diagram

Table 2-1-3 Pin Definitions

PIN	COM1			COM2			COM3	
	RS-232	RS-422	RS-485	RS-232	RS-422	RS-485	RS-232	
1	-	TX+	A	-	TX+	A	-	
2	TX	-	-	TX	-	-	TX	
3	RX			RX			RX	
4	-			RX+			-	
5	GND			GND			GND	
6	-	RX-	-	-	RX-	-	-	
7	-	-		RTS	-		-	RTS
8	-			CTS				CTS
9	-	TX-	B	-	TX-	B	-	



● For information about every model supporting communication port, see the [Hardware specifications table](#) stated in section 1.3 “Product specifications” .

● COM2 /COM3 of EC205-CT0A, EC207-CT0S and EC207-CT1S use the same port as shown in figure 2-1-4, and can connect to 2 controllers at the same time. The pins are defined as listed in table 2-1-5.

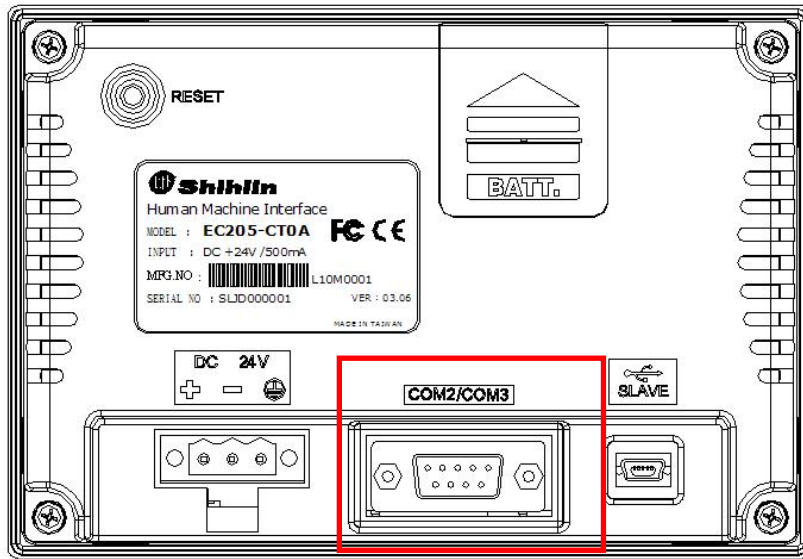

Fig. 2-1-4 、 Communication Port Diagram

Table 2-1-5 Pin Definitions

PIN	COM2/COM3		
	COM2	COM3	
	RS-422	RS-485	RS-232
1	TX+	A	-
2	-	-	TX
3	-	-	RX
4	RX+	-	-
5	GND		
6	RX-	-	-
7	-	-	RTS
8	-	-	CTS
9	TX-	B	-

### 2.1.3. Communications Support

The following Table 2-1-4 lists the brands of products supported by the ports.

Table 2-1-4 List of Supported Devices

COM	Brands	Interface	
COM1	BARCODE	RS-232	
	DELTA-DVP	RS-232/RS-422	
	FACON-FB	RS-232/RS-422	
	INVERTER	RS-422/RS-485	
	FX-MODULE	RS232/RS422/RS485	
	MELSEC-A	RS-232(COM3)	
	MELSEC-Alpha	RS-232(COM3)	
	A-Computer-Link	RS232/RS422/RS485	
	MELSEC-FX	RS-422	
	MELSEC-Q	RS-232/RS-422	
	MELSEC-QnA	RS-232	
	MELSEC-QnU	RS232	
	COM2	Q-Computer-Link	RS232/RS422/RS485
		MELSEC-Servo	RS422
	COM3	MODBUS	RS-485
		OMRON	RS-232
		Panasonic-FP	RS-232
		THERMO_CTRL	RS-485
		VIGOR-V	RS-232/RS-422
		SIEMENS	RS-232/RS-422
Allen Bradley		RS232	
Schneider		RS485	
Xinle		RS232/RS485	
Keyence		RS232	
Ethernet	MELSEC	FX3U-ENET	
		QJ71E71-100	
		Q_ENET_3E	
	Any ModBus-TCP device	ModBus-TCP	
	OMRON CJ2M	OMRON-TCP	

The following Table 2-1-5 lists the brands of PLC models supported by the HMI.

Table 2-1-5 Lists of Supported Models

Brands	Models		
<b>Mitsubishi</b>	FX2	Q01	A1SH
	FX-0N	Q02	A2SH
	FX-0S	Q06H	A2US
	FX-1S	Q12H	Q2AS
	FX-1N	Q25H	Alpha-2
	FX-2N	Q00UJ	Q_ENET_3E
	FX-3U	Q01U	QJ71E71-100
	FX-3G	Q02U	FX-3U-NET
<b>Delta-DVP</b>	SS	ES	EH
	EH2	SA	SX
	SC	SV	EX
	SS2	SA2	SE
<b>Facon-FB</b>	FBs	FBe	
<b>OMRON</b>	CP1H	CPM2AH	CJ1M
	CP1L	CPM2C	CJ2M
	CPM1A	CQM1H	CP1E
<b>VIGOR-V</b>	VB0	VB1	VB2
	VH		
<b>Panasonic-FP</b>	FP-X	FP0	FP2
	FP-e	FPΣ	FP0R
<b>SIEMENS</b>	S7-200	S7-300	
<b>Allen-Bradley</b>	MicroLogix		
<b>Schneider</b>	TM218		
<b>Xinle</b>	XCM		
<b>Keyence</b>	KV-700	KV-nano	
<b>LS</b>	Master-K120S	Master-K-CNET	



- The HMI provides simultaneous uses of the 4 communication ports.
- Mitsubishi Q\_ENET\_3E supports the format of Mitsubishi network 3E communication.
- If you use Panasonic FPΣ, The device settings please select "Panasonic FPE" in the EU Editor2 editing software.

## 2.1.4. PLC Connections

### a. Shihlin Inverter

RS-422/RS-485 are connected to SE/SL/SS series inverters as shown in figure 2-1-6.

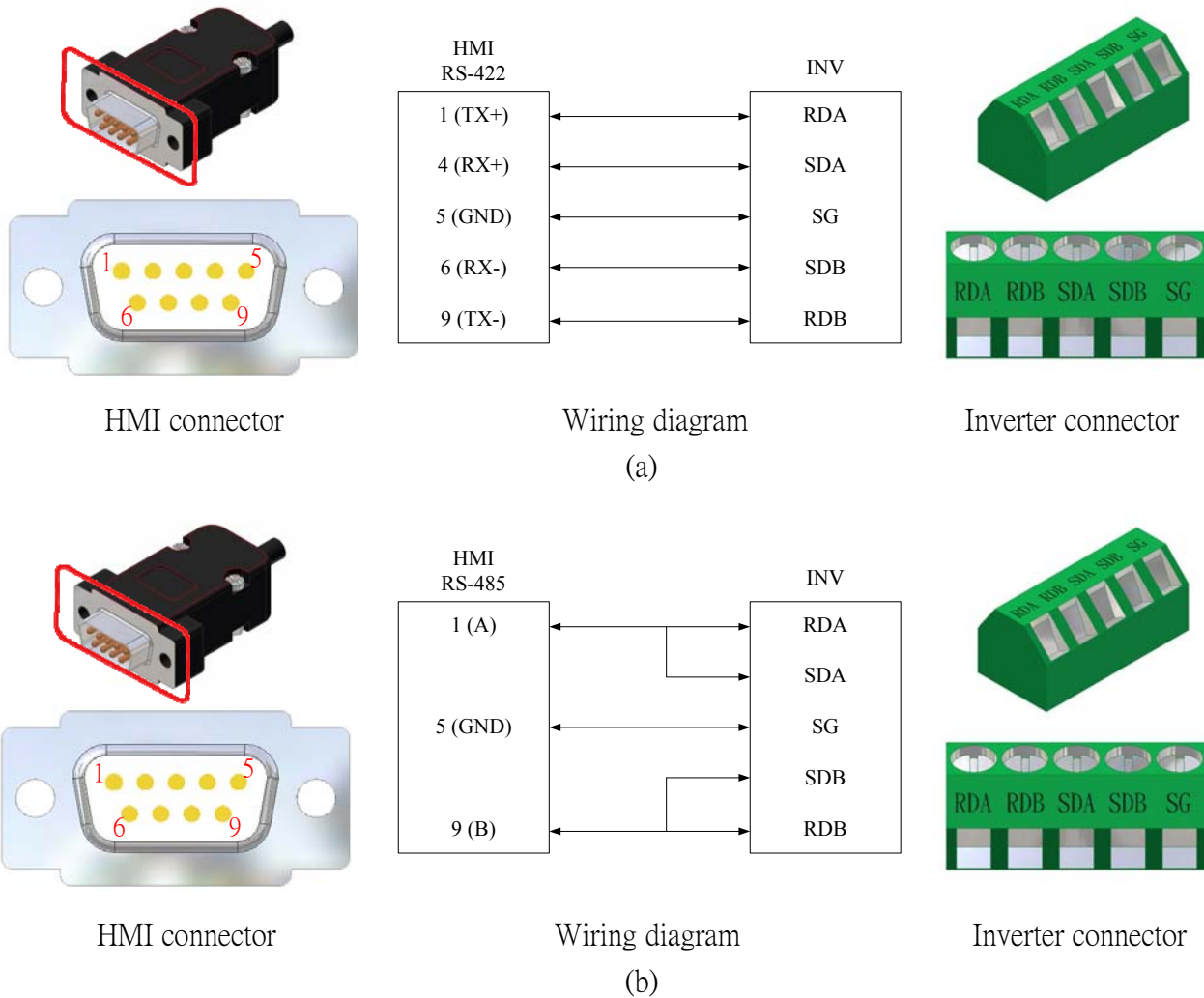

Figure 2-1-6: Connection of SE/SL/SS series inverters (a) RS-422(b) RS-485

RS-485 is connected to SH/SF/SF-G series inverters as shown in figure 2-1-7.

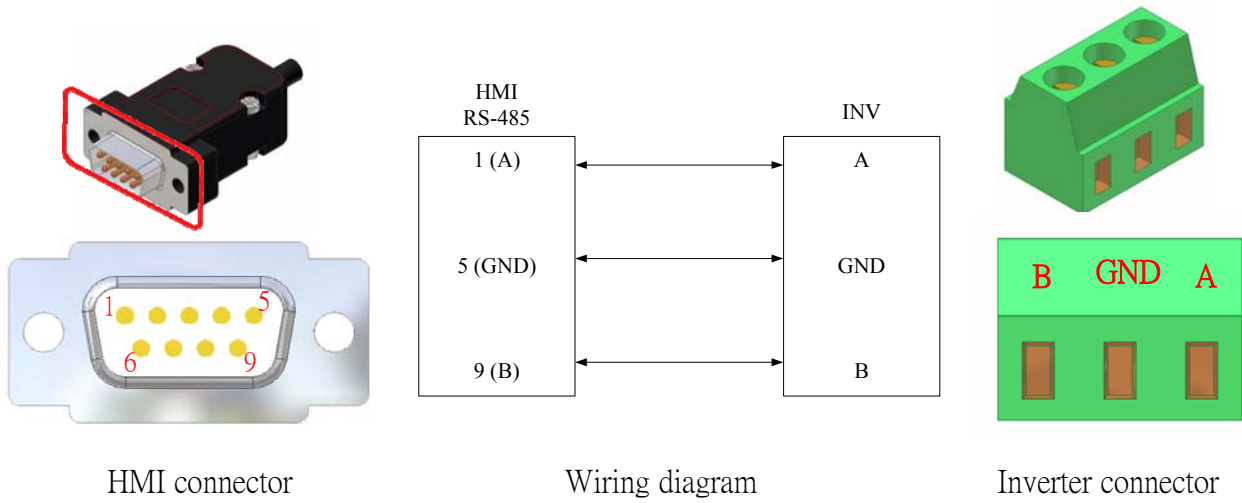

Figure 2-1-7: Connection of SH/SF/SF-G series inverters

RS-485 is connected to SE2 series inverters as shown in figure 2-1-8.

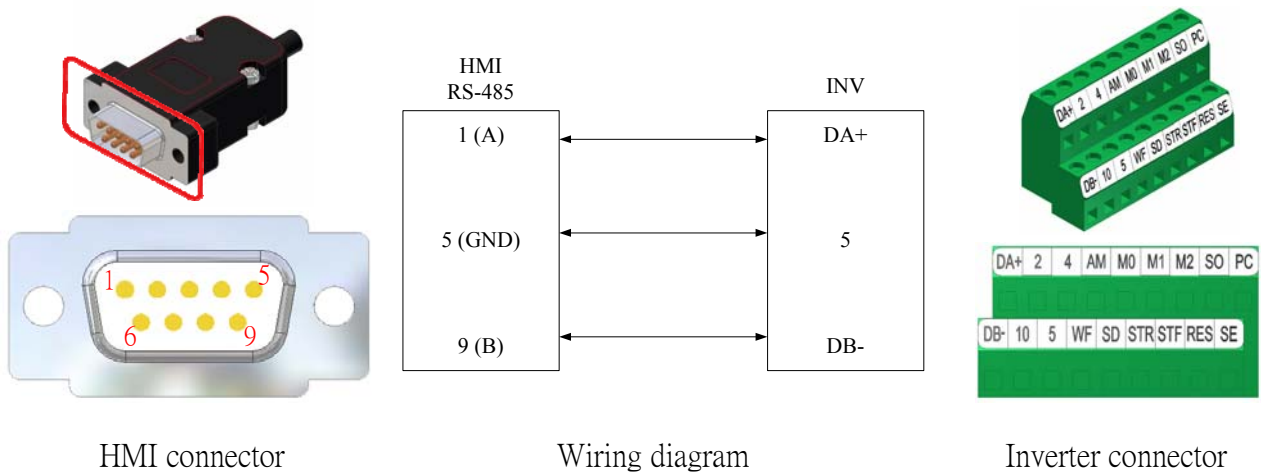

Figure 2-1-8: Connection of SE2 series inverters

RS-485 is connected to SS2 series inverters as shown in figure 2-1-9.

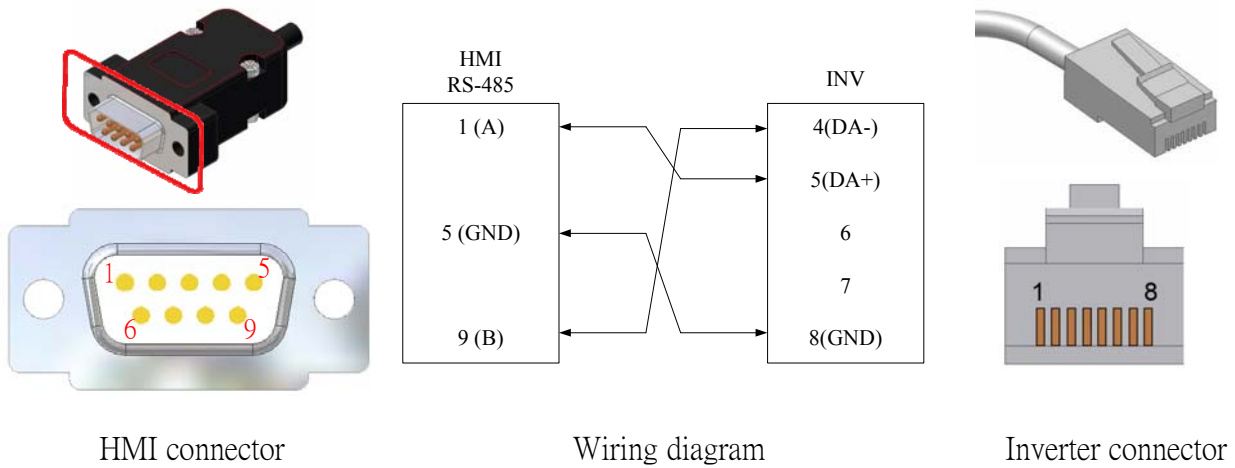

Figure 2-1-9: Connection of SS2 series inverters



- When the INVERTER communication is selected, 16 inverters can be connected at most, so the office number is set to 1~16.
- The inverter's devices IIW and IDW are write-only, and IIR and IDR are read-only. If you select a write-only device to read, or select a read-only device to write, it will not function in HMI.

## b. Shihlin Temperature Controller

Configuration of the RS-485 connection is shown in the following Figure 2-1-10.

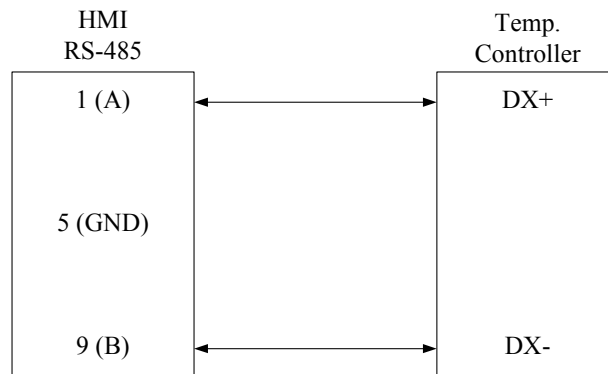

Fig. 2-1-10 Temperature Connection



- When the THERMO\_CTRL connection is selected, it can connect up to 31 units, and the station numbers are set to 1~31.



### c. Mitsubishi FX Series

Configuration of the RS-422 connection is shown in the following Figure 2-1-11.

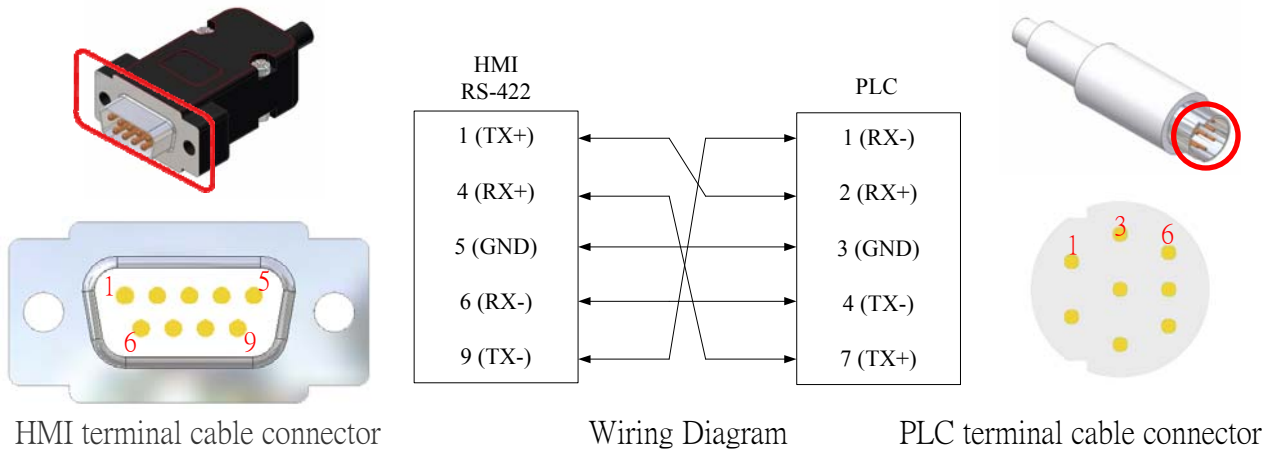

Fig. 2-1-11 RS-422 Communications Wiring

When FX2 series connecting, must use the RS-232 communication cable connected

AX-232AW-S communication cable , This is shown in Figure 2-1-12.

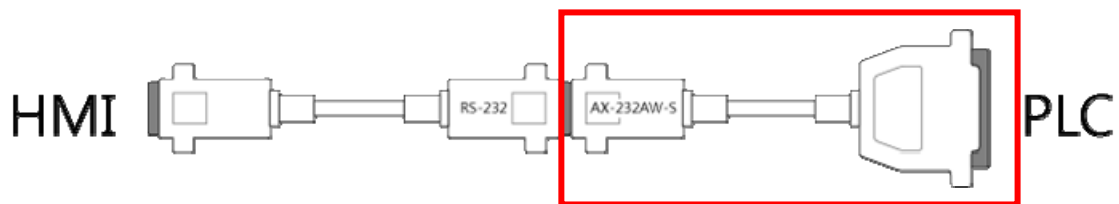

Figure 2-1-12: Connection diagram

Configuration of the RS-232 and FX2 connection is shown in the following Figure

2-1-13.

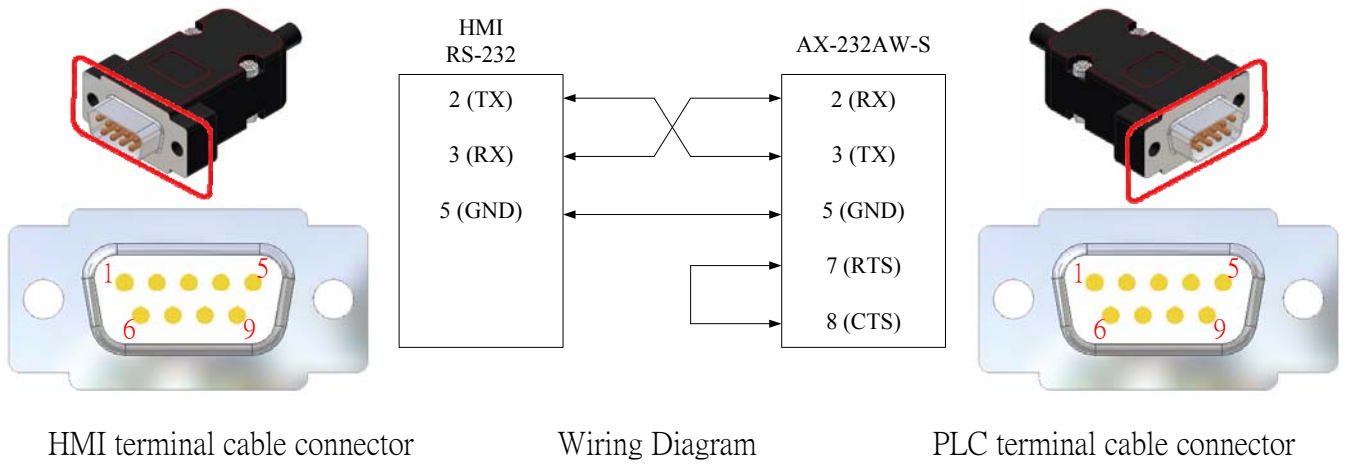

Fig. 2-1-13 FX2 Connection

### d. Mitsubishi FX Series – Computer Link

When the Mitsubishi FX Series is connected with an external 232-BD module, wire the RS-232 connection as shown in Figure 2-1-14.

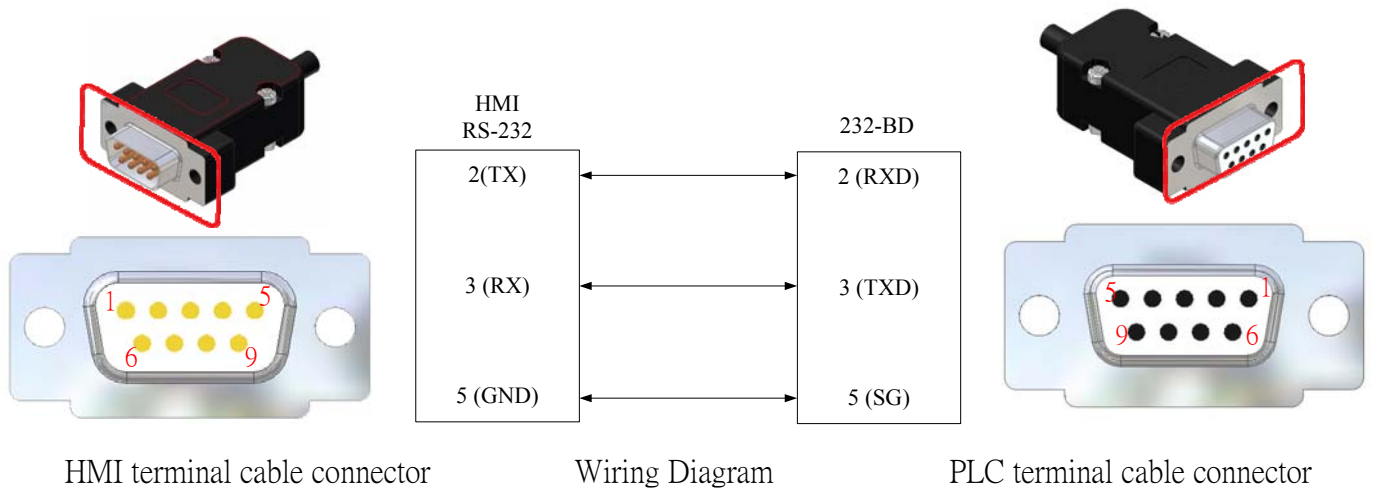

Fig. 2-1-14 RS-232 Communications Wiring

When the Mitsubishi FX Series is connected with an external 422-BD module, wire the RS-422 connection as shown in Figure 2-1-15.

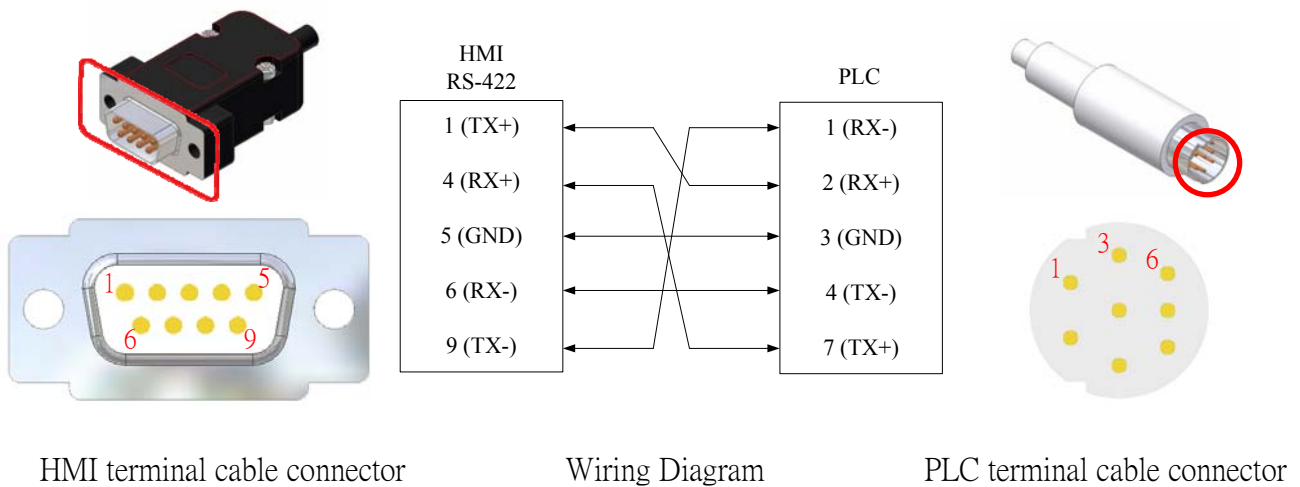

Fig. 2-1-15 RS-422 Communications Wiring

When the Mitsubishi FX Series is connected with an external 485-BD module, wire the RS-485 connection as shown in Figure 2-1-16.

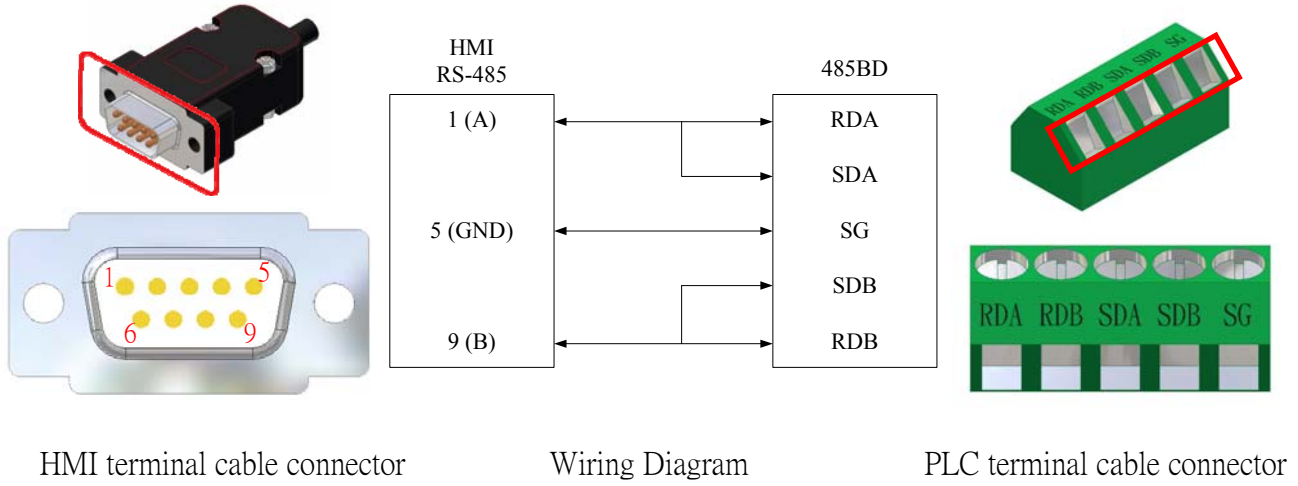

Fig. 2-1-16 RS-485 Communications Wiring



The following table 2-1-17 lists the FX series external module serial setting example, the actual set still mainly user needs.

Table 2-1-17 Lists of 232-BD module serial setting

BD module serial setting	Baud Rate(Bps)	Parity	Data Length	Stop Bit	CR/LF Select	PLC D8120 Device
232-BD(Type1)	9600	Even	7	1	None	6886(HEX)
232-BD(Type4)					CR&LF	E886(HEX)
422-BD(Type1)					None	6086(HEX)
485-BD(Type1)					None	6086(HEX)

### e. Mitsubishi Q Series

Configuration for the RS-232 connection is shown in the following Figure 2-1-18.

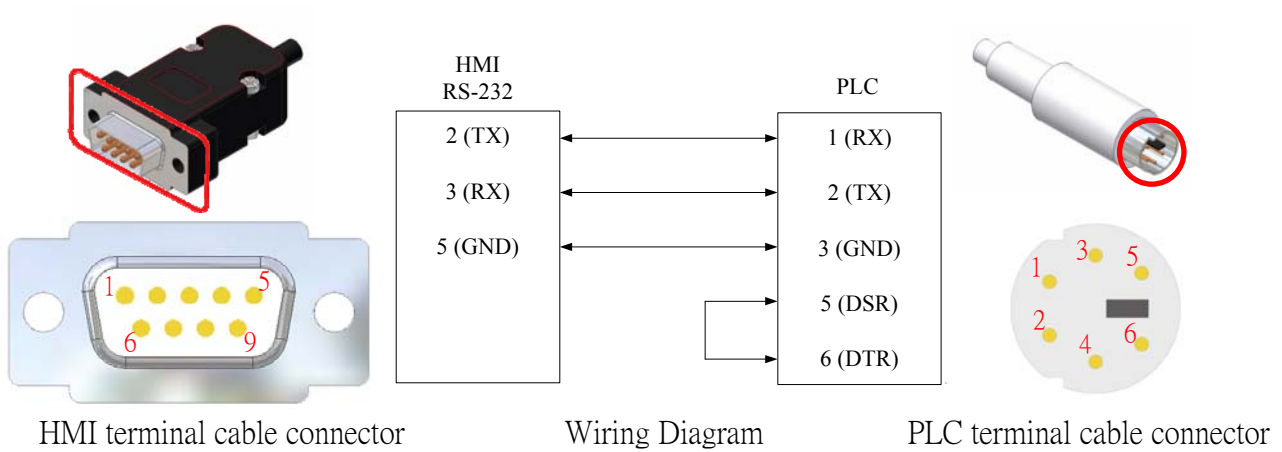

Fig. 2-1-18 Q Series Connection



- Setting of the PLC software serial parameters: configure to use serial communication, select the transmission speed, and set RUN to write mode, as shown in Figure 2-1-19.

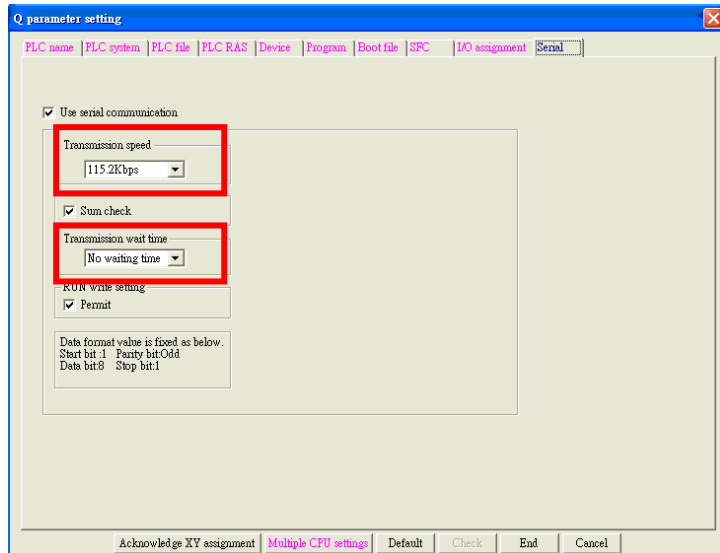

Fig. 2-1-19 Setting Parameters

## f. Mitsubishi Q Series – Computer Link

When the Mitsubishi Q Series is connected with an external QJ71C24 expansion module, wire the RS-232 connection as shown in Figure 2-1-20.

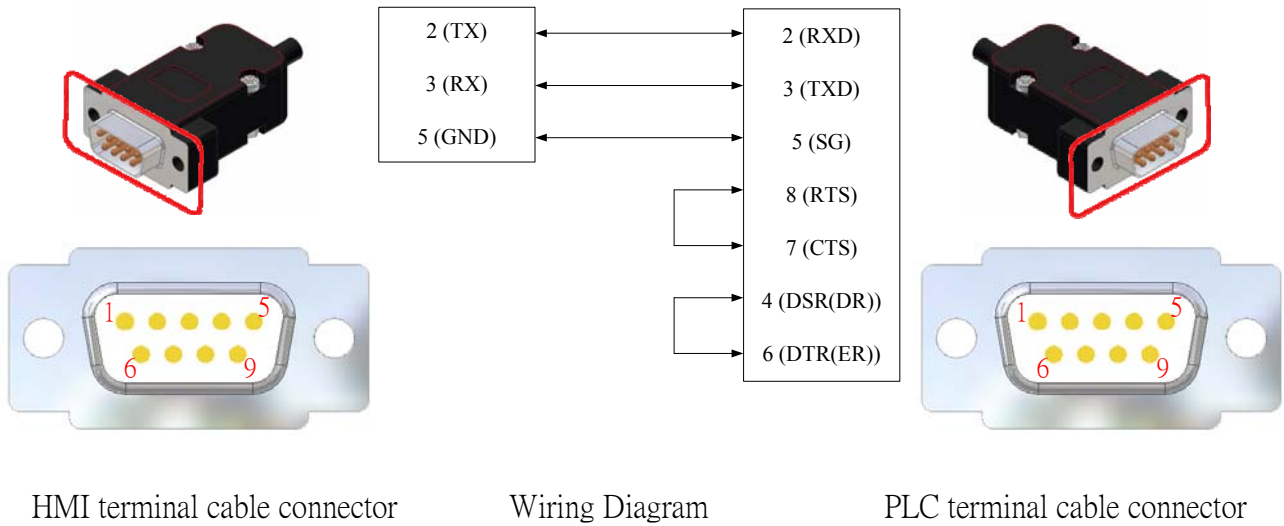

Fig. 2-1-20 RS-232 Communications Wiring

Configuration of the RS-422 connection is shown in Figure 2-1-21.

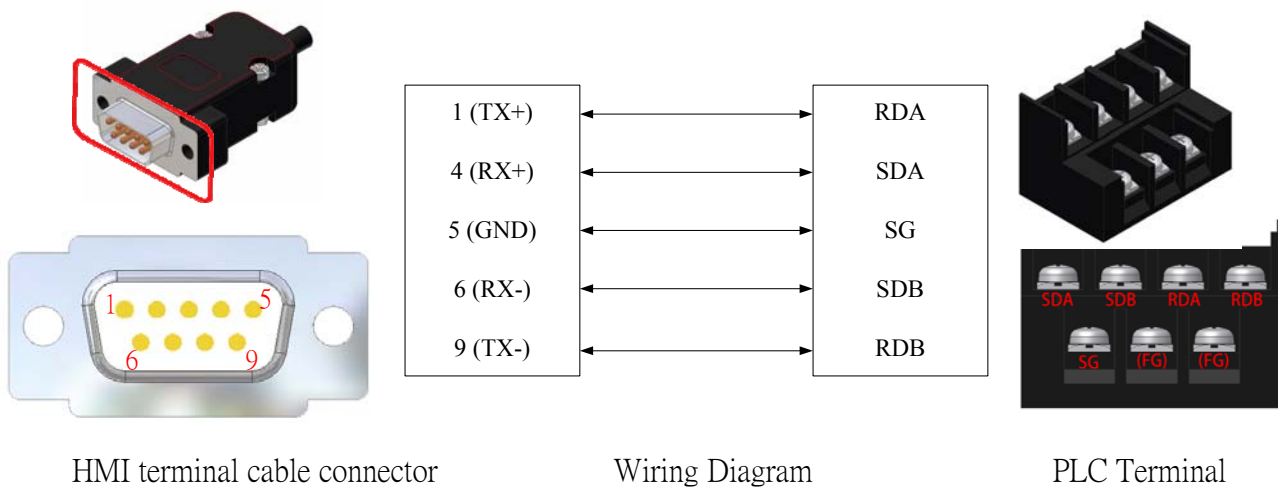
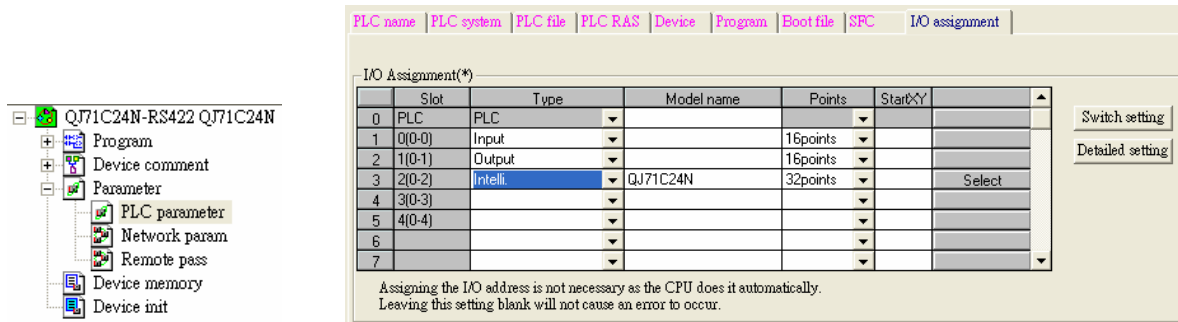

Fig. 2-1-21 RS-422 Communications Wiring

To configure the communication settings for the Mitsubishi Q serie to be connected with an external QJ71C24 expansion module, execute the GX Developer software, and follow the steps shown below.

**Step 1 :** Select the PLC parameters, and set the expansion model in the configuration column, then click the “Select” button to start the communication setting.



**Step 2 :** After the model is selected, set up the communication configuration.

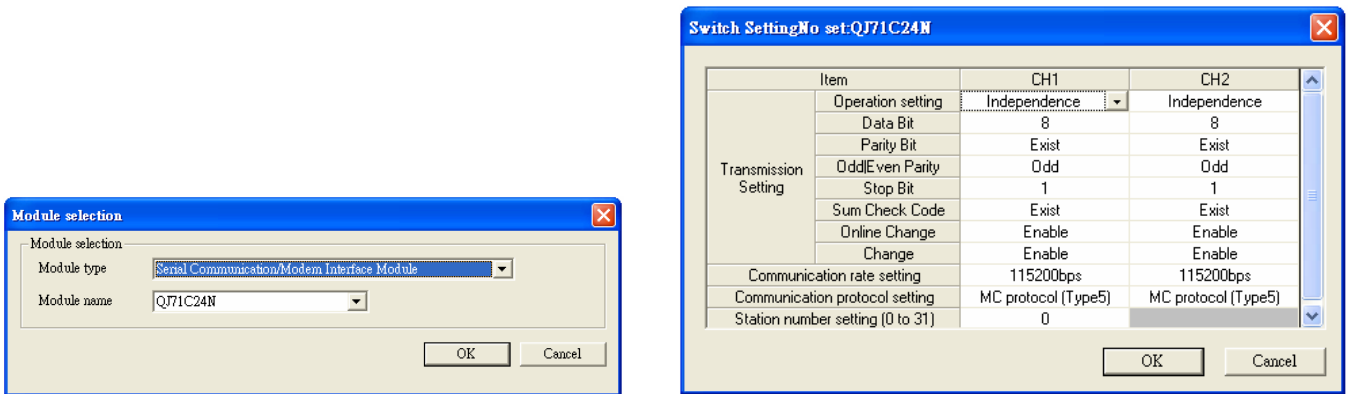

Communication Setting	Baud rate (Bps)	Parity	Data bits	Stop bit	Protocol
CH1(RS-232)	115200	Odd	8	1	MC protocol (Type5)
CH2(RS-422)					

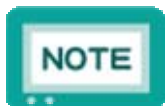

- For configuration details of the Mitsubishi Q Series expansion module, please refer to Mitsubishi PLC manual.

g. Mitsubishi QnA Series

When QnA series connecting, must use the RS-232 communication cable connected

AX-232AW-S communication cable , This is shown in Figure 2-1-22

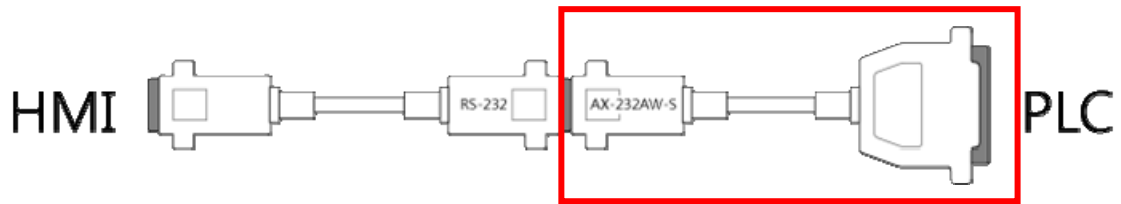

Figure 2-1-22: Connection diagram

Configuration for the RS-232 connection is shown in Figure 2-1-23.

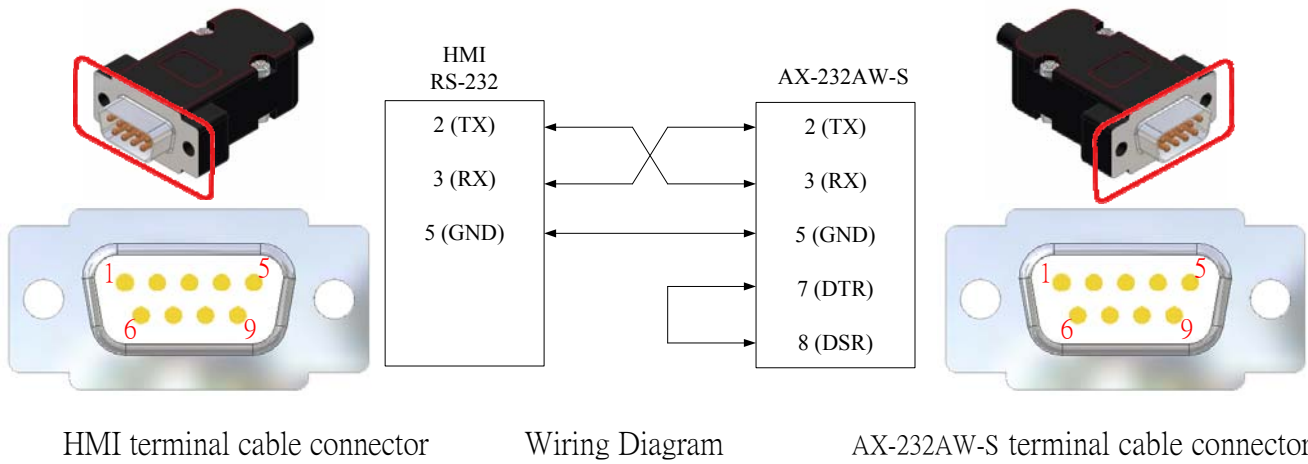

Fig. 2-1-23 QnA Series Connection



## h. Mitsubishi A Series

When A series connecting, must use the RS-232 communication cable connected AX-232AW-S communication cable , This is shown in Figure 2-1-24

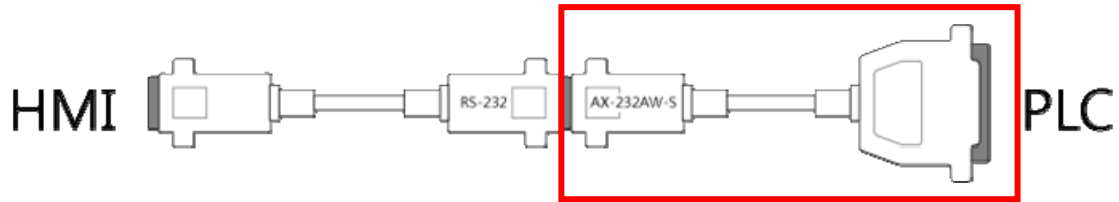
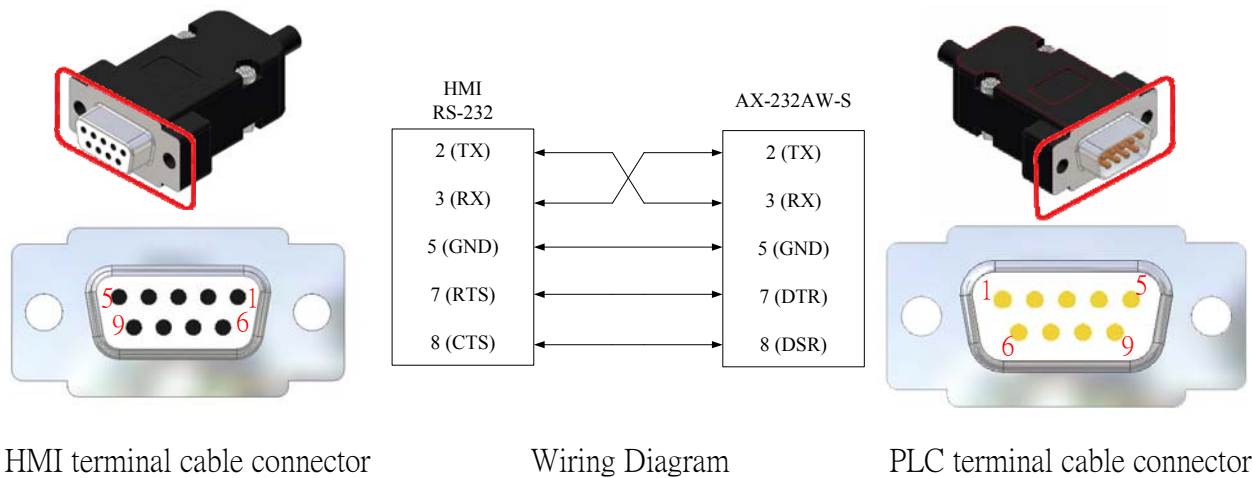

Figure 2-1-24: Connection diagram

Configuration for the RS-232 connection is shown in Figure 2-1-25.



HMI terminal cable connector

Wiring Diagram

PLC terminal cable connector

Fig. 2-1-25 A Series Connection



- The Mitsubishi A series PLC shall be connected to the HMI COM3 by using a communication cable.

### i. Mitsubishi A Series - Computer Link

When the Mitsubishi A Series is connected with an A1SJ71UC24-R2 expansion module, wire the RS-232 connection as shown in Figure 2-1-26.

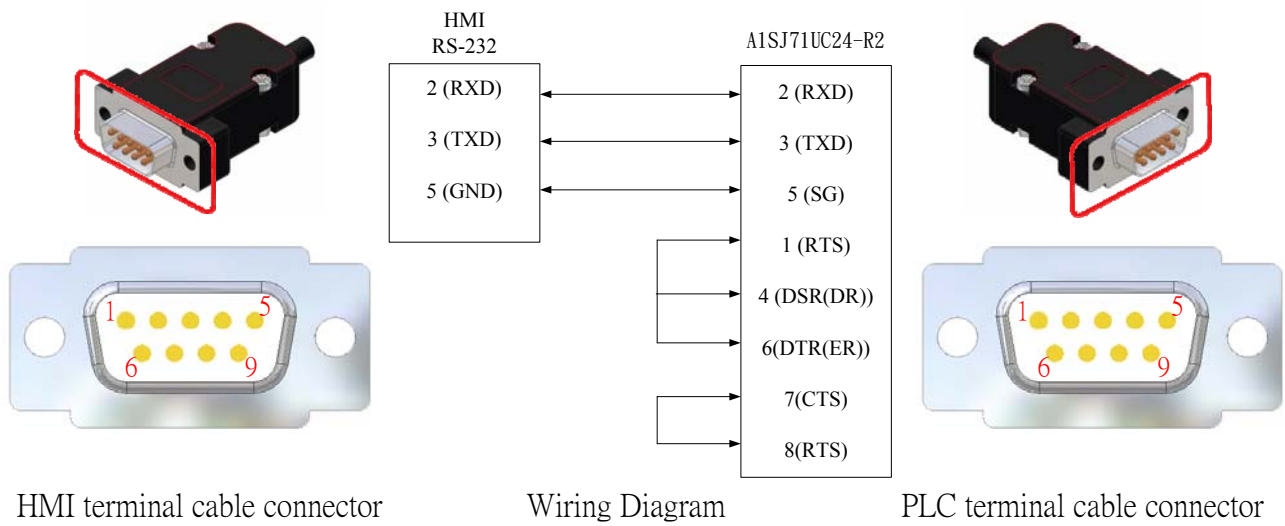

Fig. 2-1-26 Connection with A1SJ71UC24-R2 expansion module

## j. Mitsubishi Alpha Series

When Alpha -2 series connecting, must use the RS-232 communication cable connected AL2-GSM-CAB communication cable , This is shown in Figure 2-1-27.

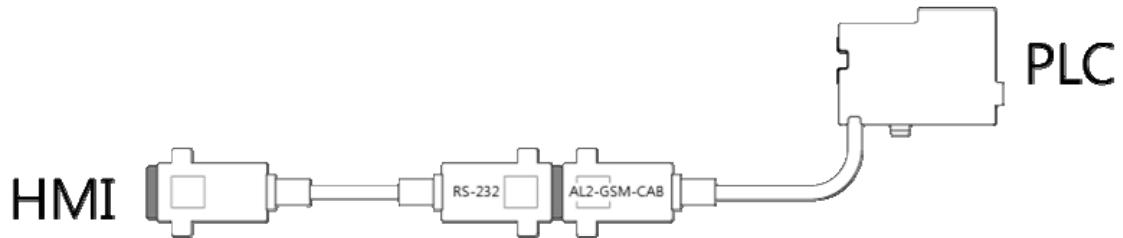
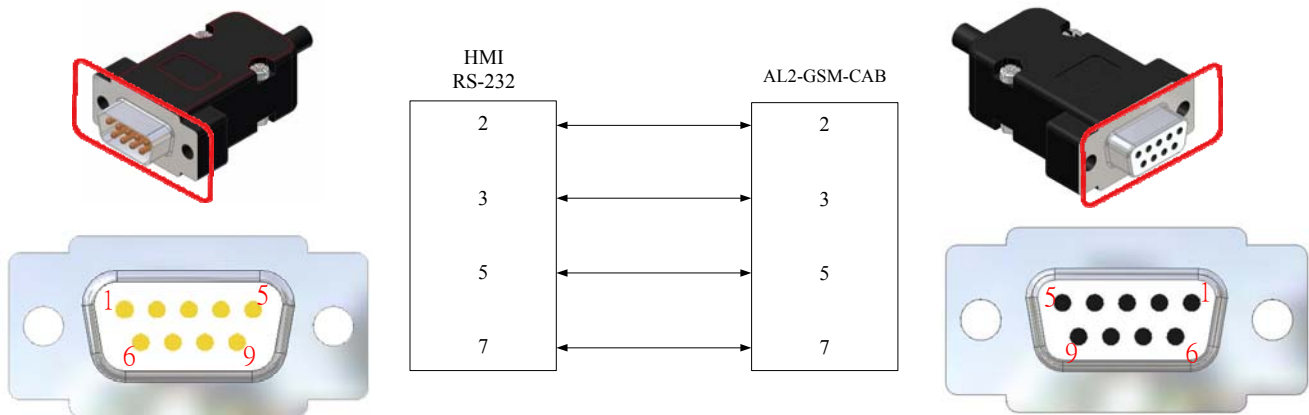

Figure 2-1-27: Connection diagram

Configuration for the RS-232 connection is shown in Figure 2-1-28.



HMI terminal cable connector

Wiring Diagram

AL2-GSM-CAB terminal cable connector

Fig. 2-1-28: RS-232 Communications Wiring

The following table lists Alpha-2 parameter settings. Users can set parameters according to test requirements.

Baud rate(Bps)	Check code	Data bit	Stop bit
9600	None	8	1

Devices are described in the following table:

Device name	Type	Address range
M (System Bit)	Bit Read-only device	1~24
I (Input Terminal)	Bit device	1~15
EI (Exter Input)		129~132
O (Output Terminal)		1~9
EO (Exter Output)		129~132
K (Key Input)		1~8
E (Link Input)		1~4
A (Link Output)		1~4
N (Control device)		1~4
CB (Communication Bit Devise)		1~100
AI (Analog In)		Word device
CW (Communication Word Devise)	1~100	



- The Mitsubishi Alpha-2 series PLC shall be connected to the HMI COM3 by using a communication cable.

k. Delta DVP Series

Configuration for the RS-232 connection is shown in Figure 2-1-29.

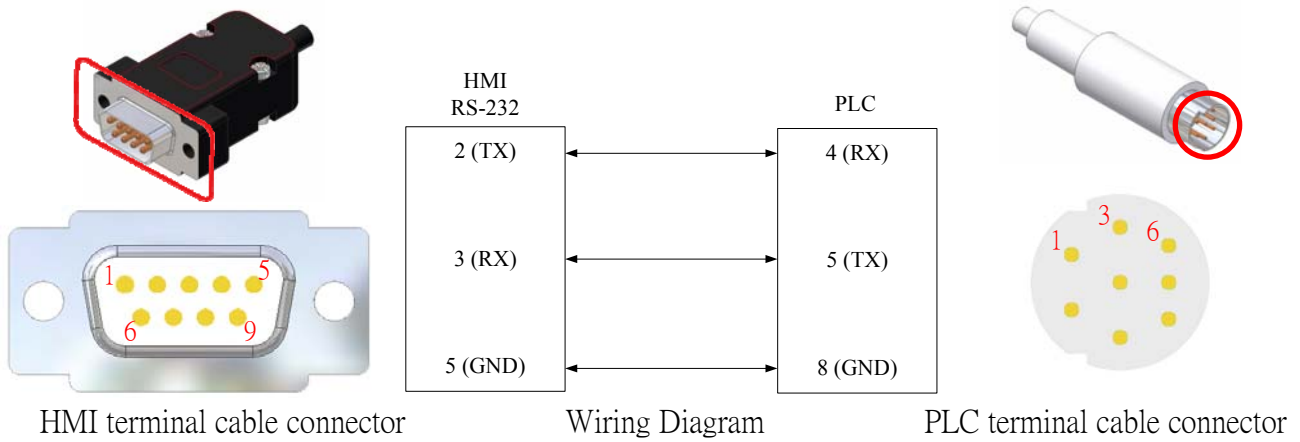

Fig. 2-1-29 RS-232 Communications Wiring

Configuration for the RS-485 connection is shown in Figure 2-1-30.

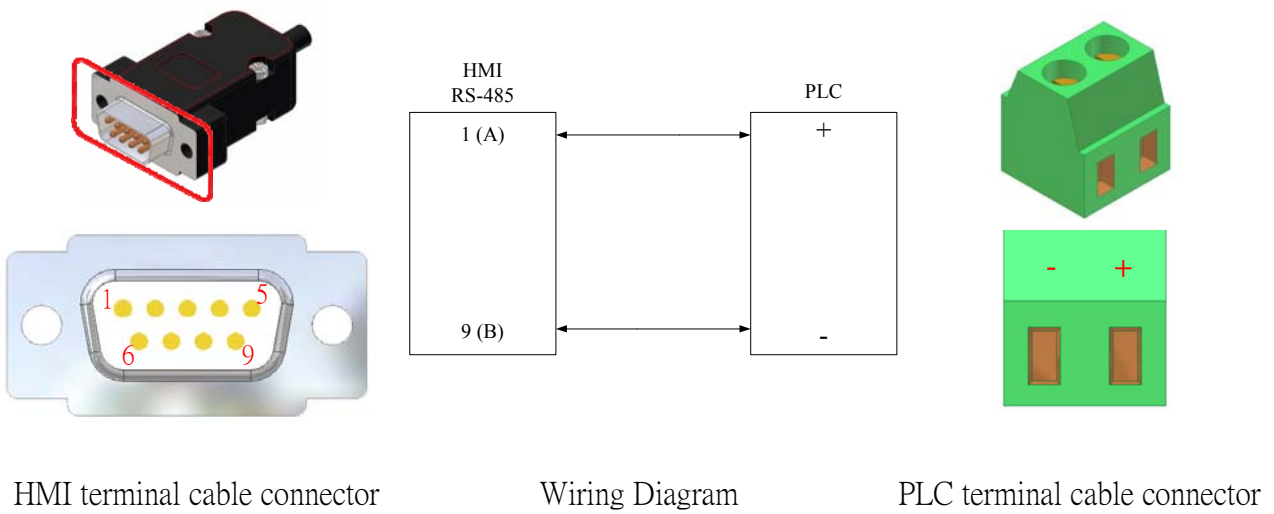
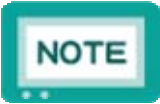

Fig. 2-1-30 RS-485 Communications Wiring



- The PLC station internal number is 1 by default, so the component of the edit screen should have the station number set to 1 before the communication can begin.

This is shown in Figure 2-1-31.

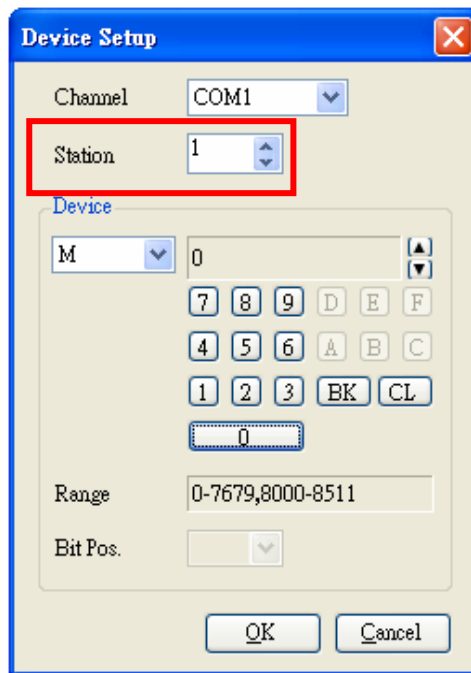

Fig. 2-1-31 Station Number Setup

# 1. Fatek FBs Series

Configuration for the RS-232 connection is shown in Figure 2-1-32.

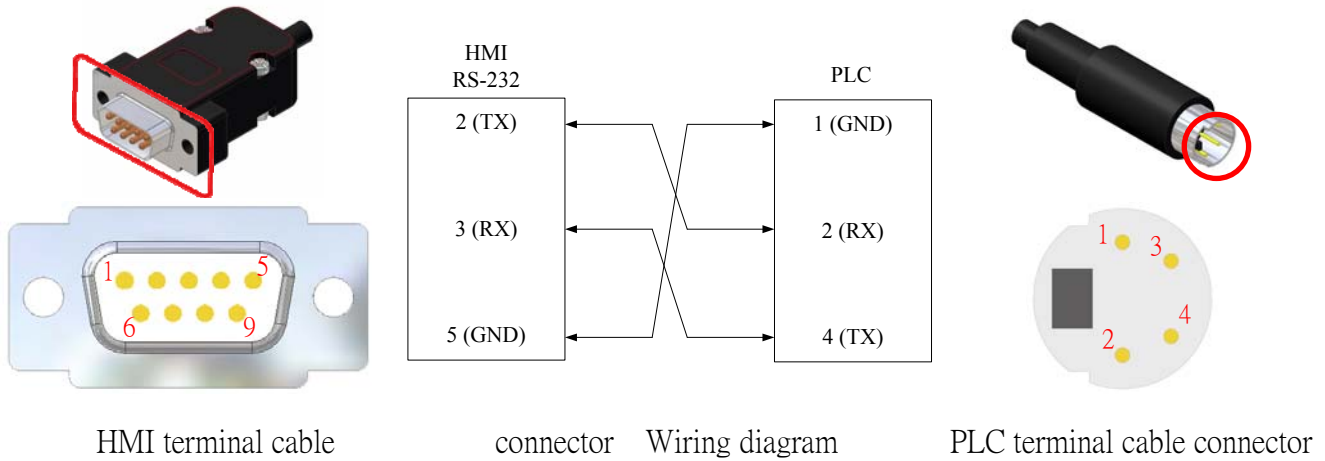

Figure 2-1-32: Connection of FATEK FB

FBe series Configuration for the RS-232 connection is shown in Figure 2-1-33.

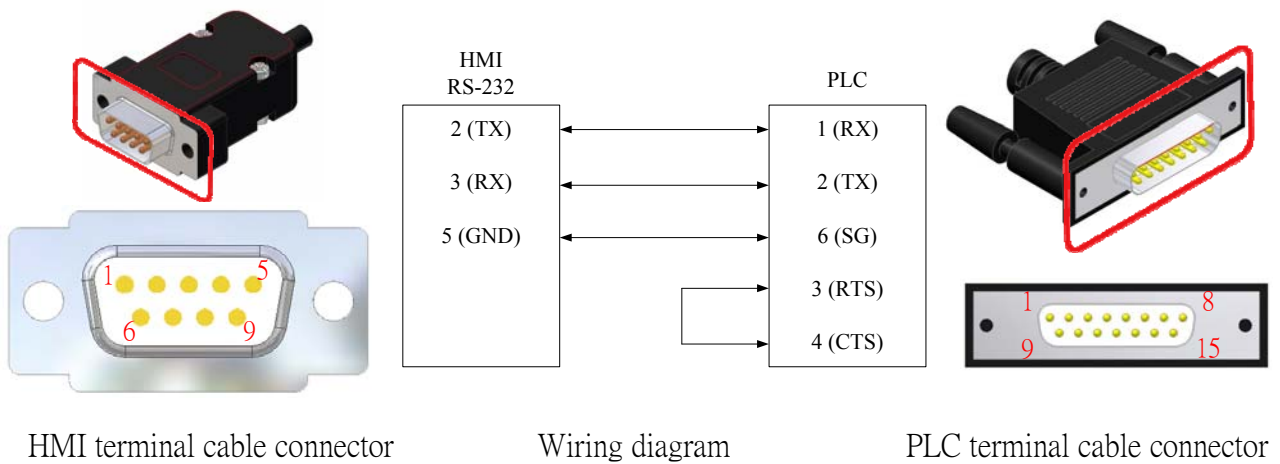

Figure 2-1-33: Connection of FBe series

When FATEK FB series PLC connects to FBs-CB22 expansion communication board, RS-232 is connected as shown in figure 2-1-34.

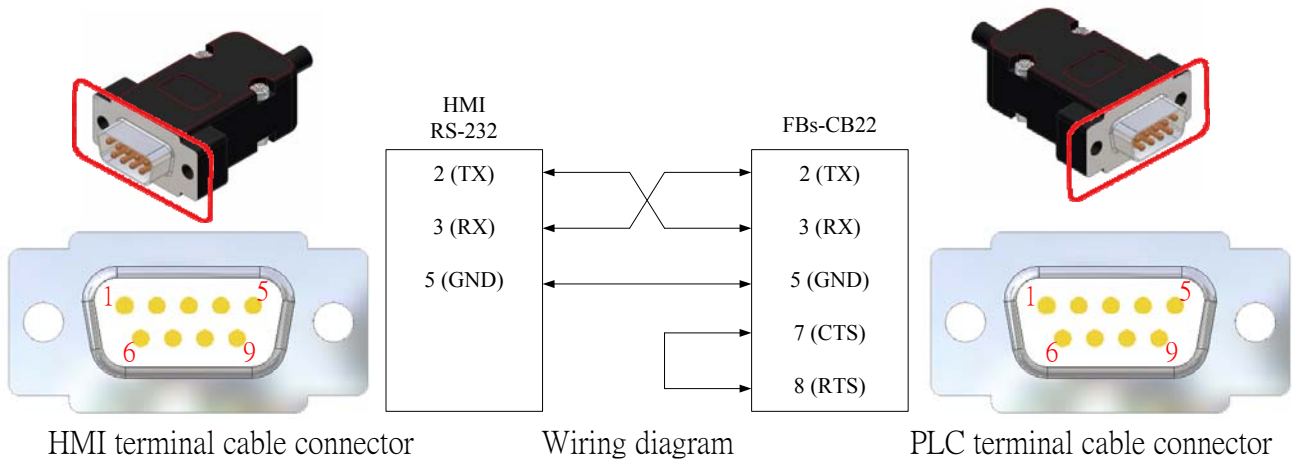

Figure 2-1-34: Connection of FBs-CB22 expansion communication board

When FATEK FB series PLC connects to FBs-CB55 expansion communication board, RS-485 is connected as shown in figure 2-1-35.

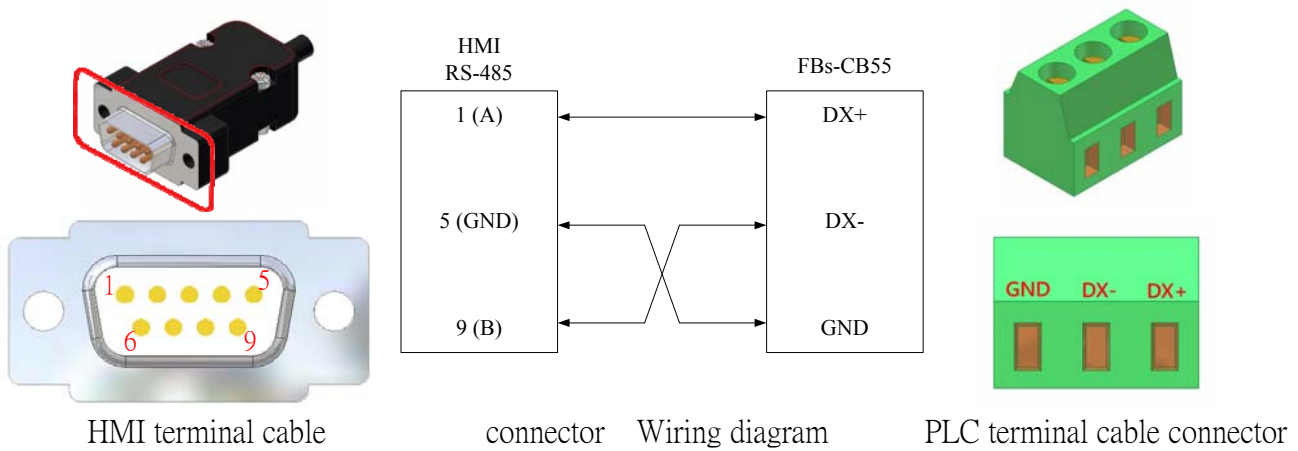
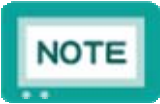

Figure 2-1-35: Connection of FBs-CB55 expansion communication board





- The default office number is 1 in PLC, so the device office number in the edit screen shall be set to 1 in order to communicate, as shown in figure 2-1-36.

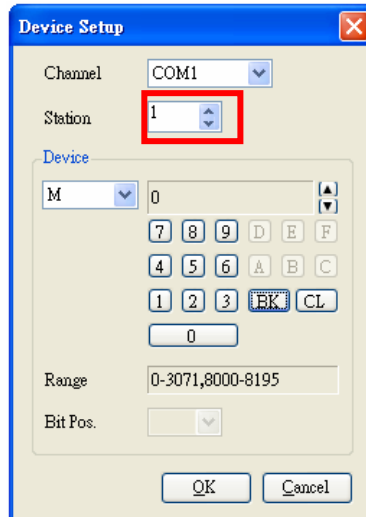

Figure 2-1-36: Set device office number

- FATEK PLC must use the PLC edit software to start RUN so that HMI can normally write in PLC. Click the “Connect” in the PLC menu to conduct this action as shown in figure 2-1-37.

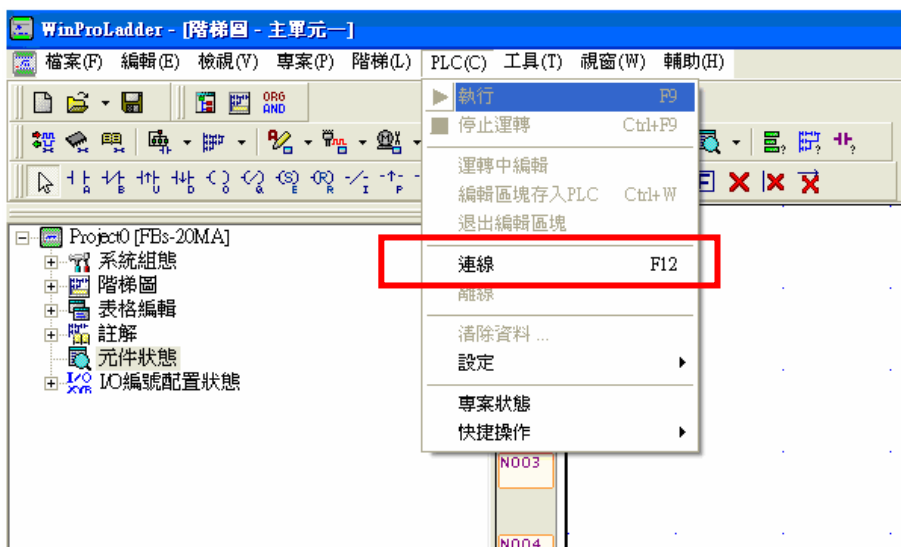

Figure 2-1-37: Set device office number

m. OMRON Series

Configuration for the RS-232 connection with CP1H、CP1L and CP1E is shown in Figure 2-1-38.

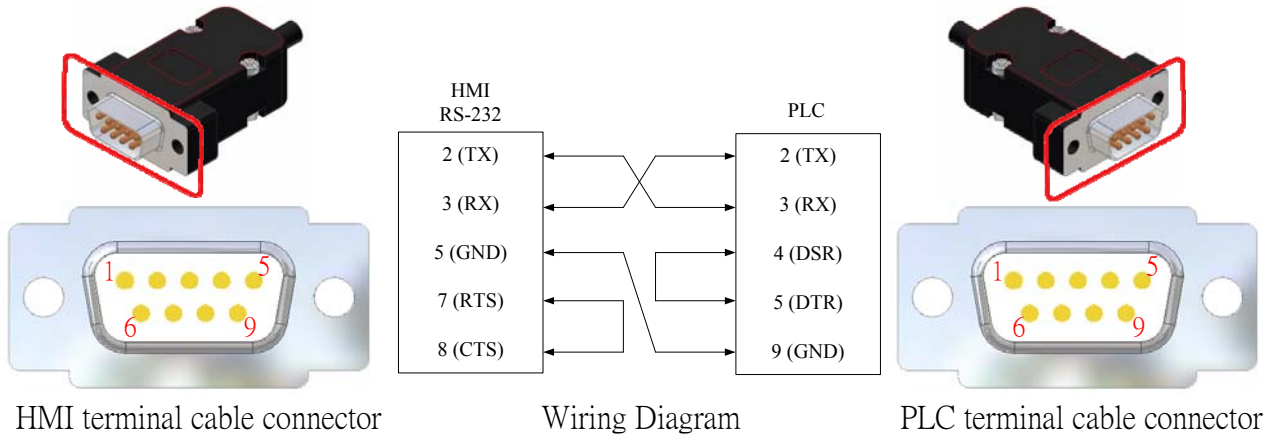

Fig. 2-1-38 OMRON Series Connection

Configuration for the RS-232 connection with CJ1M、CQM1H and CPM2AH is shown in Figure 2-1-39.

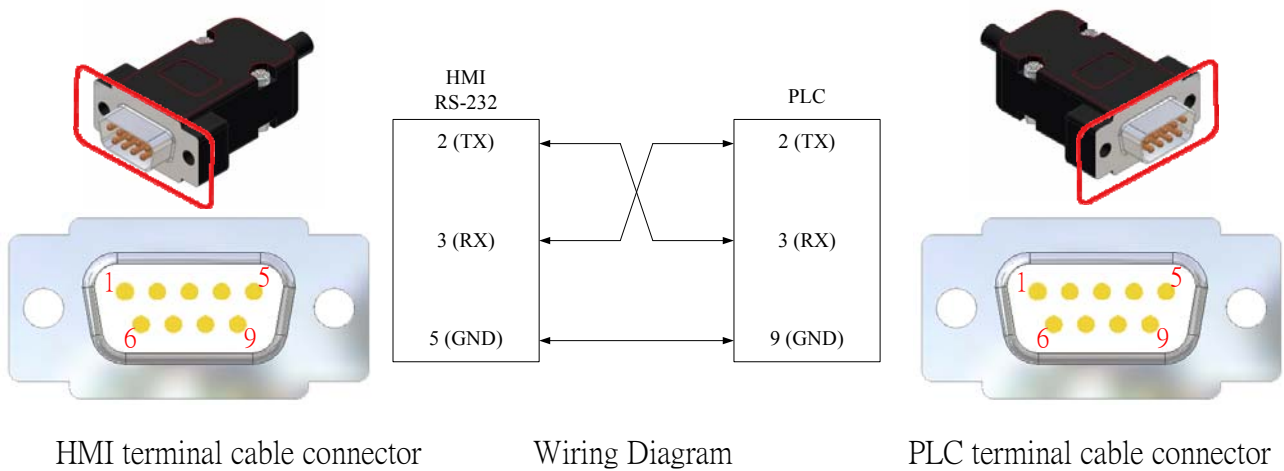

Fig. 2-1-39 OMRON Series Connection

The CPM1A and CPM2C models have no RS-232 connectors, so they need adaptor cables. The applicable adaptor cables are shown in the following Table 2-1-40. The communications wiring is shown in Figure 2-1-41.

Table 2-1-40

PLC Model	Adaptor Cable Model
CPM1A	CQM1-CIF02
CPM2C	CS1W-CN226T

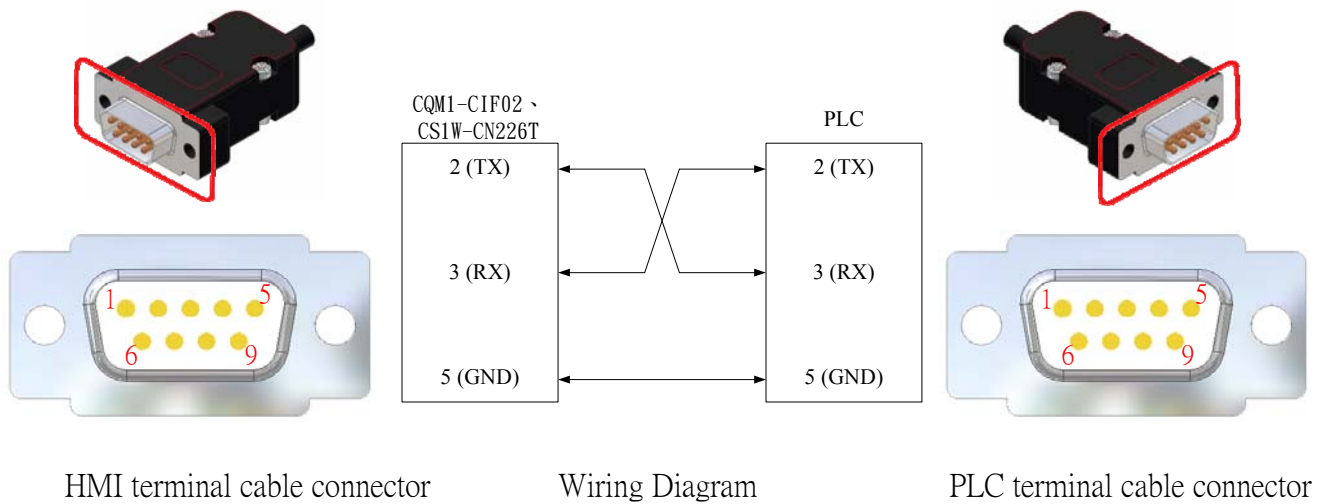

Fig. 2-1-41 OMRON Series Connection

## n. Panasonic Series

Configuration for the RS-232 connection is shown in Figure 2-1-42.

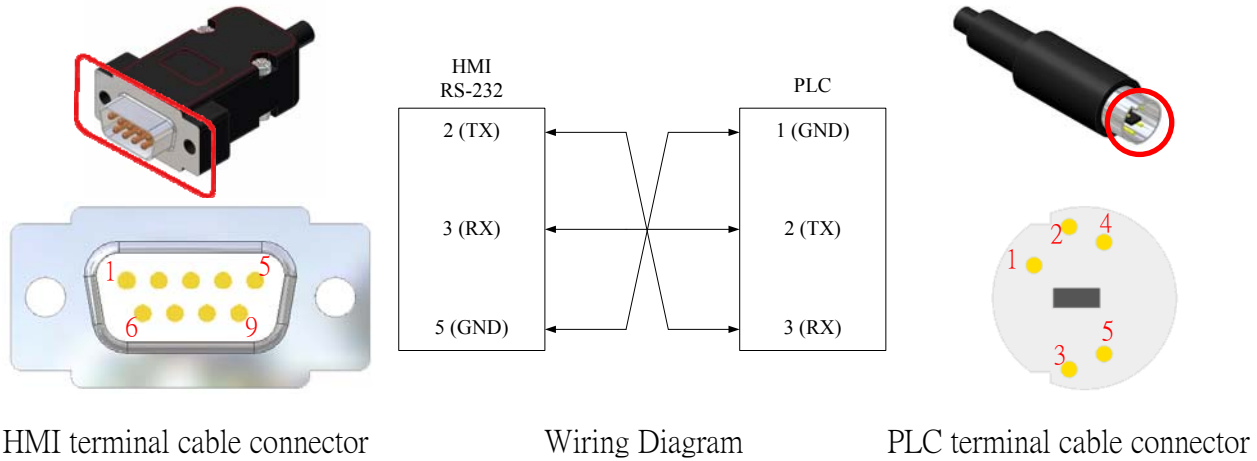

Fig. 2-1-42 Panasonic Series Connection



- If you use Panasonic FP  $\Sigma$ , The device settings please select "Panasonic FPE" in the EU Editor2 editing software.

### o. Vigor V Series

Configuration for the RS-232 connection is shown in Figure 2-1-43.

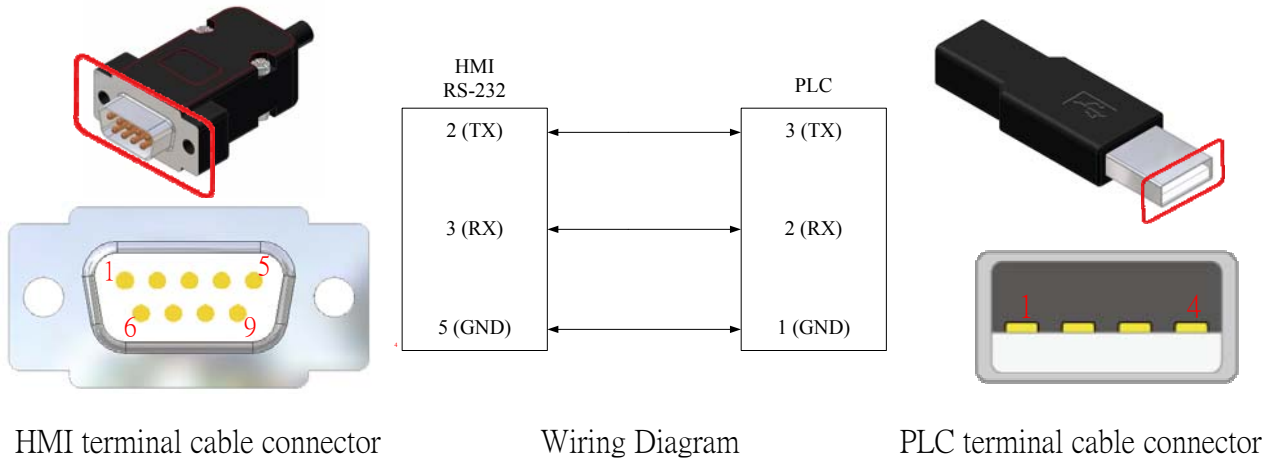

Fig. 2-1-43 Vigor V Series Connection

TEM series Single Board PLC Configuration for the RS-232 connection is shown in Figure 2-1-44.

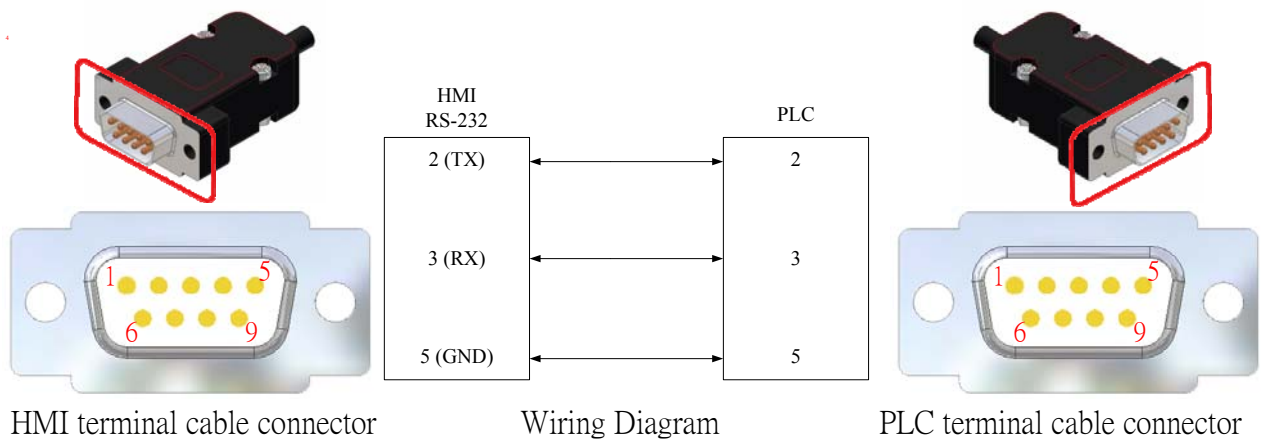

Fig. 2-1-44 Vigor TEM Series Connection

p. SIEMENS Series

Configuration for the RS-485 connection with S7-200 series is shown in Figure 2-1-44.

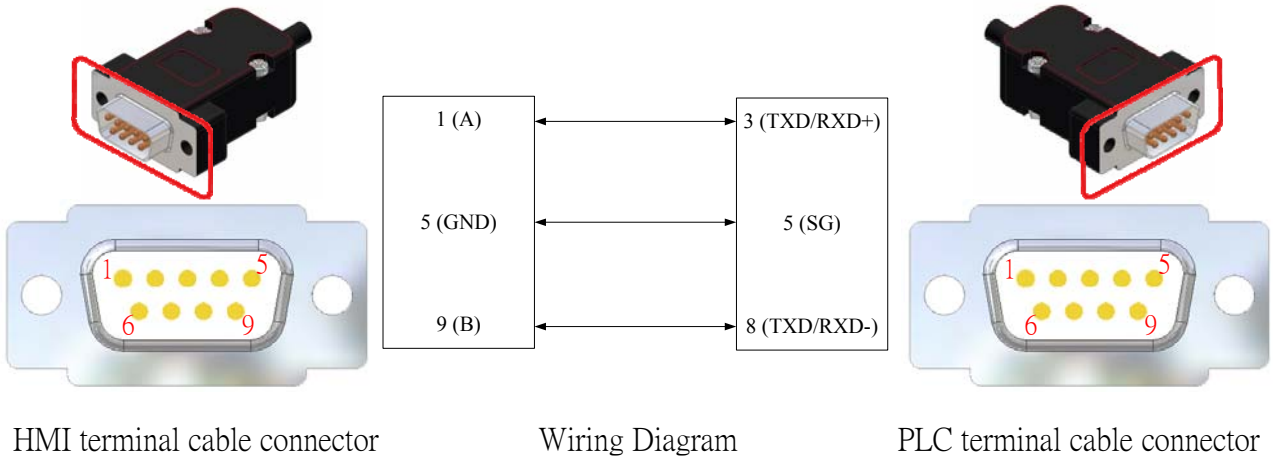

Fig. 2-1-44 RS-485 Communications Wiring

For S7-300 series, RS-232 is connected as shown in figure 2-1-45.

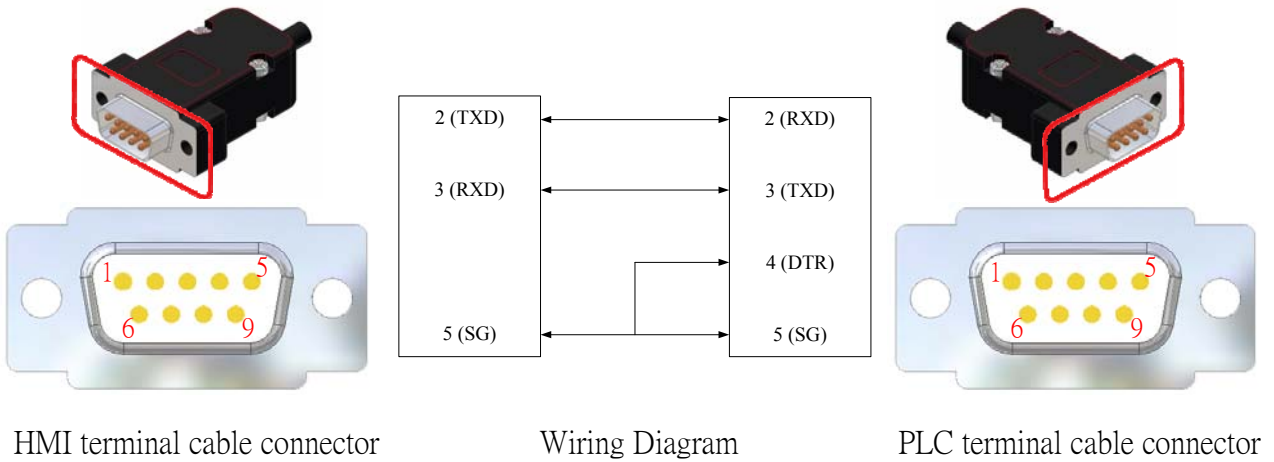

Fig. 2-1-45 RS-232 Communications Wiring



- For S7-300 series, connect RS-232 and PC Adapter and PLC in series.

q. Allen-Bradley

RS-232 is connected to MicroLogix as shown in figure 2-1-46.

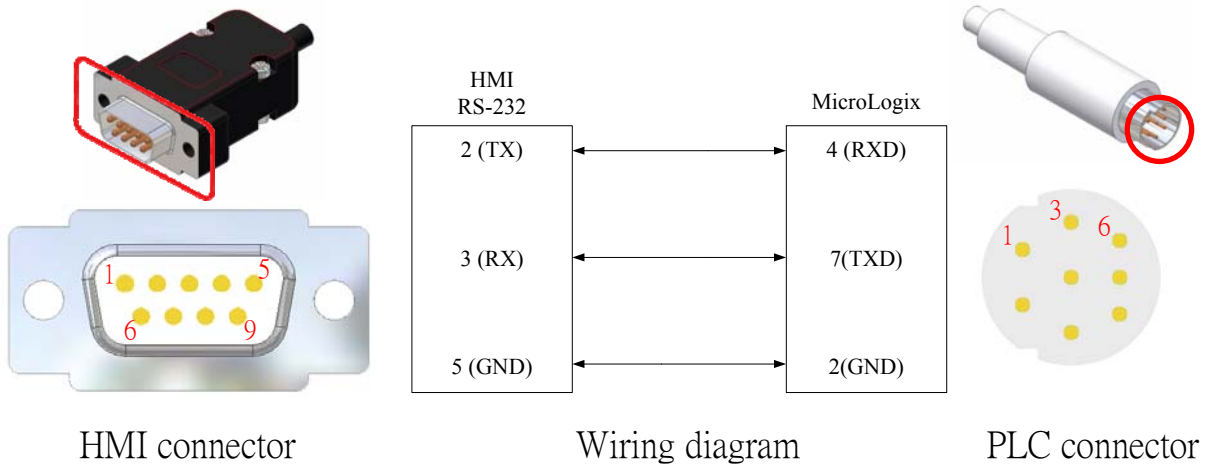

Figure 2-1-46: Connection of Allen-Bradley MicroLogix

Devices are described in the following table:

Device name	Type	Address range	File number used	
			File number	Address range
O0	Word device	0~255	-	-
I1		0~255	-	-
S2		0~255	-	-
B		-	3~255	0~255
TS		-	3~255	0~255
TP		-	3~255	0~255
TC		-	3~255	0~255
CS		-	3~255	0~255
CP		-	3~255	0~255
CC		-	3~255	0~255
R6		0~255	-	-
N		-	3~255	0~255
F8		0~255	-	-

In the EU Editor2, the file number of device for MicroLogix model can be set as shown in figure 2-1-47.

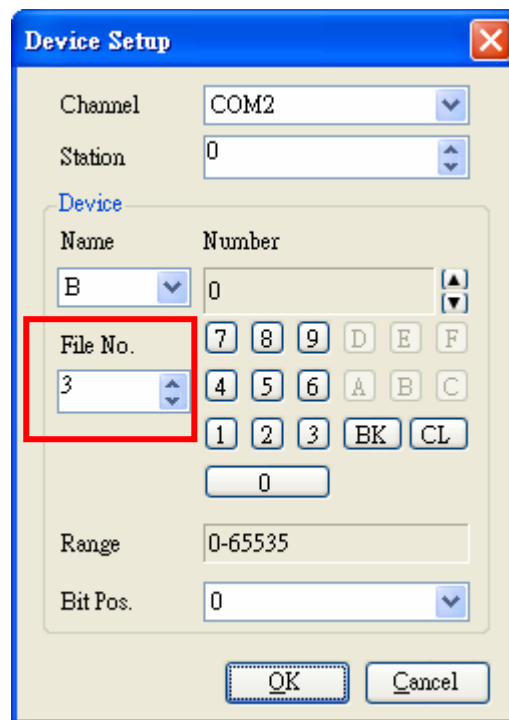

Figure 2-1-47: Device setting



- Use Allen-Bradley PLC devices when writing macro, Allen-Bradley PLC device coding has been calculated, The detailed operation please refer to the EU/EC Macro Manual.



r. Mitsubishi servo driver

RS-422 is connected to J3-A as shown in figure 2-1-48.

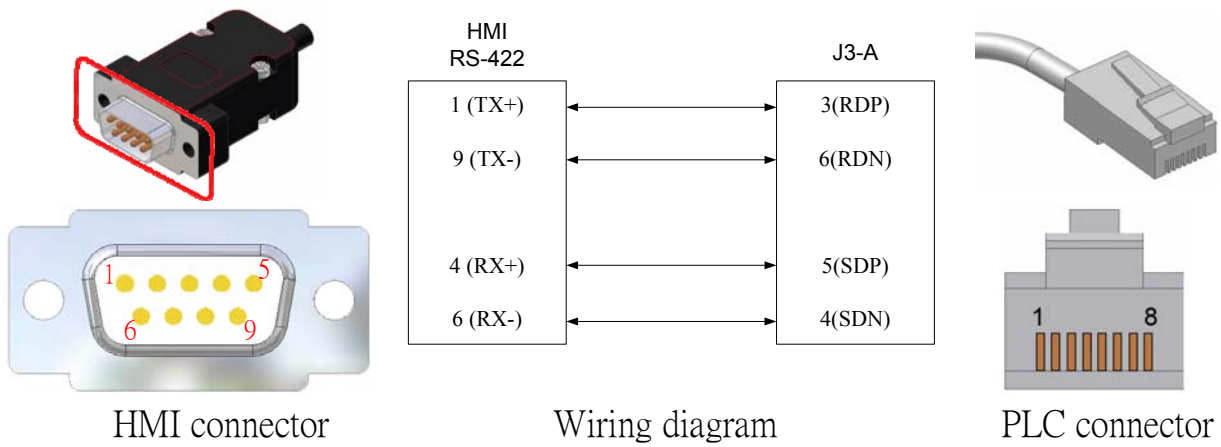

Figure 2-1-48: Connection of Mitsubishi J3-A

The following table lists J3-A parameter settings. Users can set parameters according to test requirements.

Baud rate(Bps)	Check code	Data bit	Stop bit
9600	Even	8	1

Devices are described in the following table:

Device name	Type	Address range
PA	Word device	1~15,19
PB		1~4,6~11,13~16,18~20,23~34
PC		1~24,26,30~40
PD		1,3~16,18~20,22,24
STR	Word Read-only device	0~14
ALR		0~1,11~25,200~205,210~215,230~235
DIR		0~2
DOR		0~1

Basic setting parameter	
Device name	Item
PA1	Control mode
PA2	Regenerative brake option

Device name	Item
PA3	Absolute position system
PA4	Function selection A-1
PA5	Number of command input pulses per revolution
PA6	Electronic gear numerator (command pulse multiplying factor numerator)
PA7	Electronic gear denominator (command pulse multiplying factor denominator)
PA8	Auto tuning
PA9	Auto tuning response
PA10	Control mode, regenerative brake option selection
PA11	Forward torque limit
PA12	Reverse torque limit
PA13	Selection of servo motor stop pattern at LSP/LSN signal off
PA14	Rotation direction selection
PA15	Encoder output pulses
PA19	Parameter block

Gain filter parameter	
Device name	Item
PB1	Adaptive tuning mode (Adaptive filter II)
PB2	Vibration suppression control filter tuning mode
PB3	Position command acceleration time constant
PB4	Feed forward gain
PB6	Ratio of load inertia moment to servo motor inertia moment
PB7	Model control gain
PB8	Position loop gain
PB9	Speed loop gain
PB10	Speed integral compensation
PB11	Speed differential compensation
PB13	Machine resonance suppression filter 1
PB14	Notch form selection 1
PB15	Machine resonance suppression filter 2
PB16	Notch form selection 2
PB18	Low-pass filter setting
PB19	Vibration suppression control vibration frequency setting
PB20	Vibration suppression control resonance frequency setting
PB23	Low-pass filter selection

Device name	Item
PB24	Slight vibration suppression control selection
PB25	Function selection B-1
PB26	Gain changing selection
PB27	Gain changing condition
PB28	Gain changing time constant
PB29	Gain changing, Ratio of load inertia moment to servo motor inertia moment
PB30	Gain changing, Position loop gain
PB31	Gain changing, Speed loop gain
PB32	Gain changing, Speed integral compensation
PB33	Gain changing, Vibration suppression control vibration frequency setting
PB34	Gain changing, Vibration suppression control resonance frequency setting

Extension setting parameter	
Device name	Item
PC1	Acceleration time constant
PC2	Deceleration time constant
PC3	S-pattern acceleration/deceleration time constant
PC4	Torque command time constant
PC5	Internal speed command 1 / limit 1
PC6	Internal speed command 2 / limit 2
PC7	Internal speed command 3 / limit 3
PC8	Internal speed command 4 / limit 4
PC9	Internal speed command 5 / limit 5
PC10	Internal speed command 6 / limit 6
PC11	Internal speed command 7 / limit 7
PC12	Analog speed command maximum speed / limit maximum speed
PC13	Analog torque command maximum output
PC14	Analog monitor 1 output
PC15	Analog monitor 2 output
PC16	Electromagnetic brake sequence output
PC17	Zero speed
PC18	Alarm history clear
PC19	Encoder output pulse selection
PC20	Station number. setting
PC21	communication function selection

Device name	Item
PC22	Function selection C-1
PC23	Function selection C-2
PC24	Function selection C-3
PC26	Function selection C-5
PC30	Acceleration time constant 2
PC31	Deceleration time constant 2
PC32	Command pulse multiplying factor numerator 2
PC33	Command pulse multiplying factor numerator 3
PC34	Command pulse multiplying factor numerator 4
PC35	Internal torque limit 2
PC36	Status display selection
PC37	Analog speed command offset / limit offset
PC38	Analog torque command offset / limit offset
PC39	Analog monitor 1 offset
PC40	Analog monitor 2 offset

I/O setting parameter	
Device name	Item
PD1	Input signal automatic ON selection 1
PD3	Input signal device selection 1 (CN1-15)
PD4	Input signal device selection 2 (CN1-16)
PD5	Input signal device selection 3 (CN1-17)
PD6	Input signal device selection 4 (CN1-18)
PD7	Input signal device selection 5 (CN1-19)
PD8	Input signal device selection 6 (CN1-41)
PD9	For manufacturer setting
PD10	Input signal device selection 8 (CN1-43)
PD11	Input signal device selection 9 (CN1-44)
PD12	Input signal device selection 10 (CN1-45)
PD13	Output signal device selection 1 (CN1-22)
PD14	Output signal device selection 2 (CN1-23)
PD15	Output signal device selection 3 (CN1-24)
PD16	Output signal device selection 4 (CN1-25)
PD18	Output signal device selection 6 (CN1-49)
PD19	Response level setting

Device name	Item
PD20	Function selection D-1
PD22	Function selection D-3
PD24	Function selection D-5

Status display	
Device name	Item
STR0	Cumulative feedback pulses
STR1	Servo motor speed
STR2	Droop pulses
STR3	Cumulative command pulses
STR4	Command pulse frequency
STR5	Analog speed command voltage/limit voltage
STR6	Analog torque command voltage/limit voltage
STR7	Regenerative load ratio
STR8	Effective load ratio
STR9	Peak load ratio
STR10	Instantaneous torque
STR11	Within one-revolution position
STR12	ABS counter
STR13	Load inertia moment ratio
STR14	Bus voltage

Alarm	
Device name	Item
ALR0	Current alarm number
ALR1	Detailed data of current alarms
ALR11	Servo status when alarm occurs cumulative feedback pulses
ALR12	Servo status when alarm occurs servo monitor speed
ALR13	Servo status when alarm occurs droop pulses
ALR14	Servo status when alarm occurs cumulative command pulses
ALR15	Servo status when alarm occurs command pulse frequency
ALR16	Servo status when alarm occurs analog speed command voltage/limit voltage
ALR17	Servo status when alarm occurs analog torque command voltage/limit voltage
ALR18	Servo status when alarm occurs regenerative load ratio
ALR19	Servo status when alarm occurs effective load ratio

Device name	Item
ALR20	Servo status when alarm occurs peak load ratio
ALR21	Servo status when alarm occurs instantaneous torque
ALR22	Servo status when alarm occurs within one-revolution position
ALR23	Load inertia moment ratio ABS counter
ALR24	Servo status when alarm occurs load inertia moment ratio
ALR25	Servo status when alarm occurs bus voltage
ALR200	Alarm number from alarm history most recent alarm
ALR201	Alarm number from alarm history first alarm in past
ALR202	Alarm number from alarm history second alarm in past
ALR203	Alarm number from alarm history third alarm in past
ALR204	Alarm number from alarm history fourth alarm in past
ALR205	Alarm number from alarm history fifth alarm in past
ALR210	Alarm occurrence time in alarm history most recent alarm
ALR211	Alarm occurrence time in alarm history first alarm in past
ALR212	Alarm occurrence time in alarm history second alarm in past
ALR213	Alarm occurrence time in alarm history third alarm in past
ALR214	Alarm occurrence time in alarm history fourth alarm in past
ALR215	Alarm occurrence time in alarm history fifth alarm in past
ALR230	Detailed alarm from alarm history most recent alarm
ALR231	Detailed alarm from alarm history first alarm in past
ALR232	Detailed alarm from alarm history second alarm in past
ALR233	Detailed alarm from alarm history third alarm in past
ALR234	Detailed alarm from alarm history fourth alarm in past
ALR235	Detailed alarm from alarm history fifth alarm in past

External input	
Device name	Item
DIR0	Input device statuses
DIR1	External input pin statuses
DIR2	Statuses of input devices switched on through communication

External output	
Device name	Item
DOR0	Output device statuses
DOR1	External output pin statuses

s. Schneider

RS-485 Modbus is connected to TM218 as shown in figure 2-1-49.

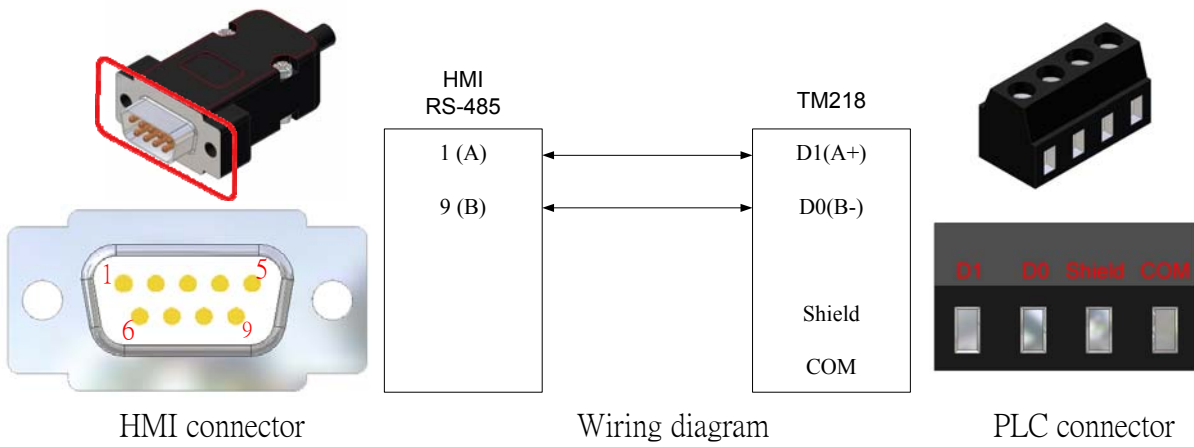

Figure 2-1-49: TM218 connection

The following table lists Schneider PLC parameter settings. Users can set parameters according to test requirements.

COM interface	Baud rate (Bps)	Check code	Data bit	Stop bit
RS485	19200	Even	8	1

Devices are described in the following table:

Device name	Type	Range
IX	Bit device	0~65535
QX		
0X		
3X	Word device	
4X		

t. Xin Je

RS-232 is connected to XCM as shown in figure 2-1-50. The communication protocol is Modbus.

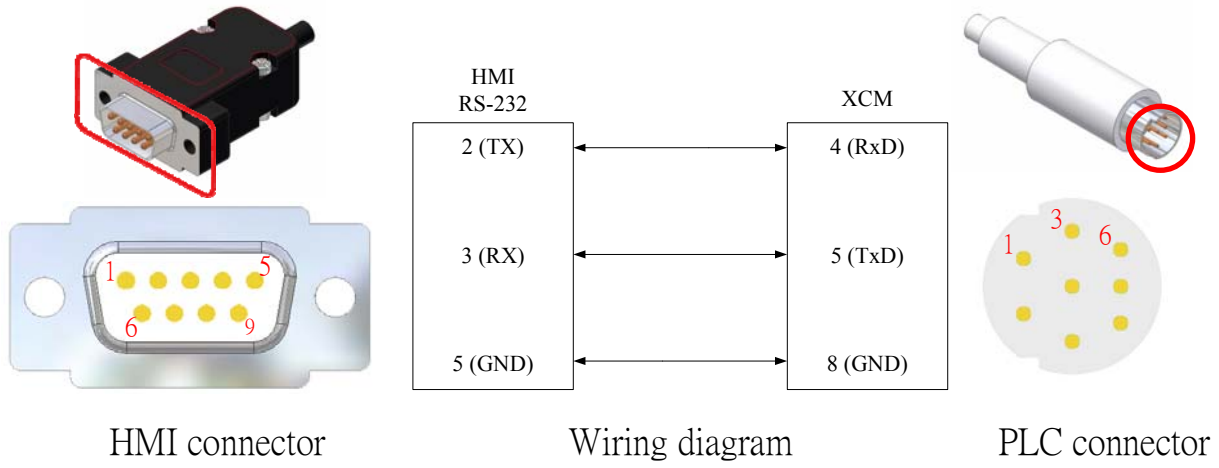

Figure 2-1-50: RS-232 connection

RS-485 is connected to XCM as shown in figure 2-1-51. Both A and B are the connection points for RS-485. The communication protocol is Modbus.

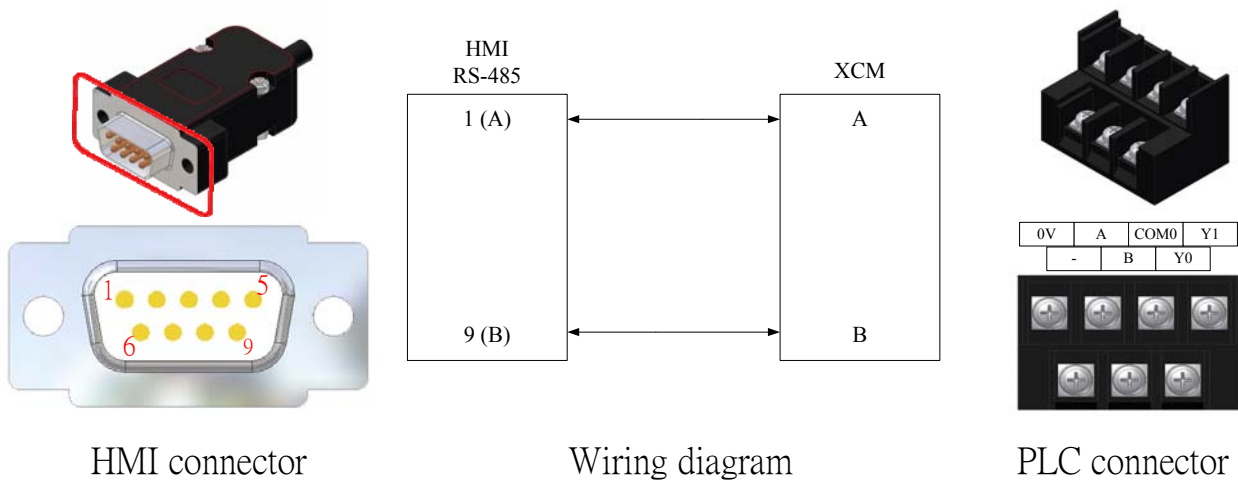

Figure 2-1-51: RS-485 connection



Devices are described as the following table:

Device name	Type	Range
M	Bit device	0~7999
X		0~543
Y		0~543
S		0~1023
M8		0~511
T		0~639
C		0~639
D	Word device	0~7999
TD		0~639
CD		0~639
D8		0~2047
FD		0~1535
FD8		0~2047
ED		0~36862
ID		0~9999
QD	0~9999	

u. Keyence

RS-232 is connected to KV Series as shown in figure 2-1-52.

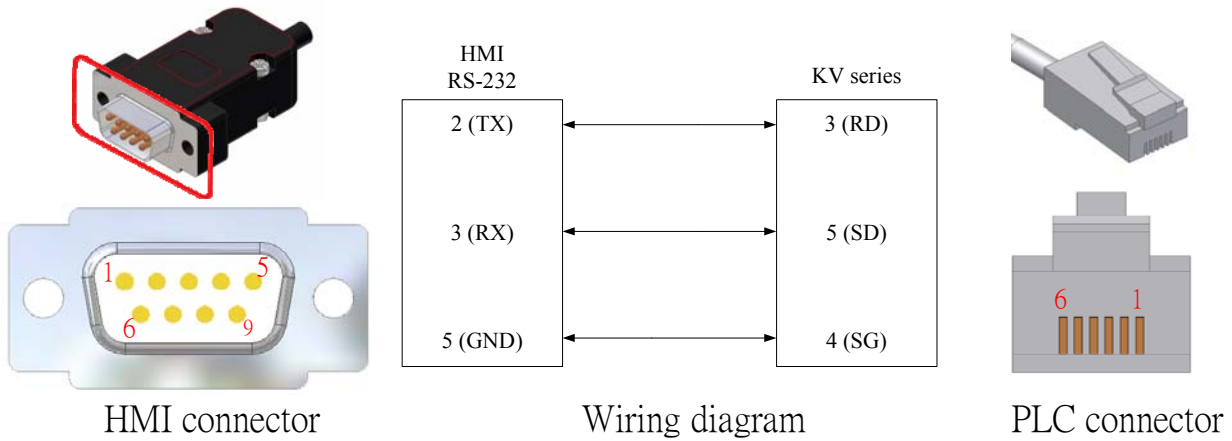

Figure 2-1-52: RS-232 connection

Devices are described as follows:

Device name	Type	Range
RLY	Bit device	0~99915
CR		0~3915
MR		0~99915
LR		0~99915
B		0~3FFF
T		0~3999
C		0~3999
TC	Word device	0~3999
TP		0~3999
CC		0~3999
CP		0~3999
CM		0~11998
DM		0~65534
TM		0~511
EM		0~65534
FM		0~32766
CTC		0~3
CTH	0~1	



- Use Keyence PLC devices when writing macro, Keyence PLC device coding has been calculated, The detailed operation please refer to the [EU/EC Macro Manual](#).

v. LS

RS-232 is connected as shown in figure 2-1-53.

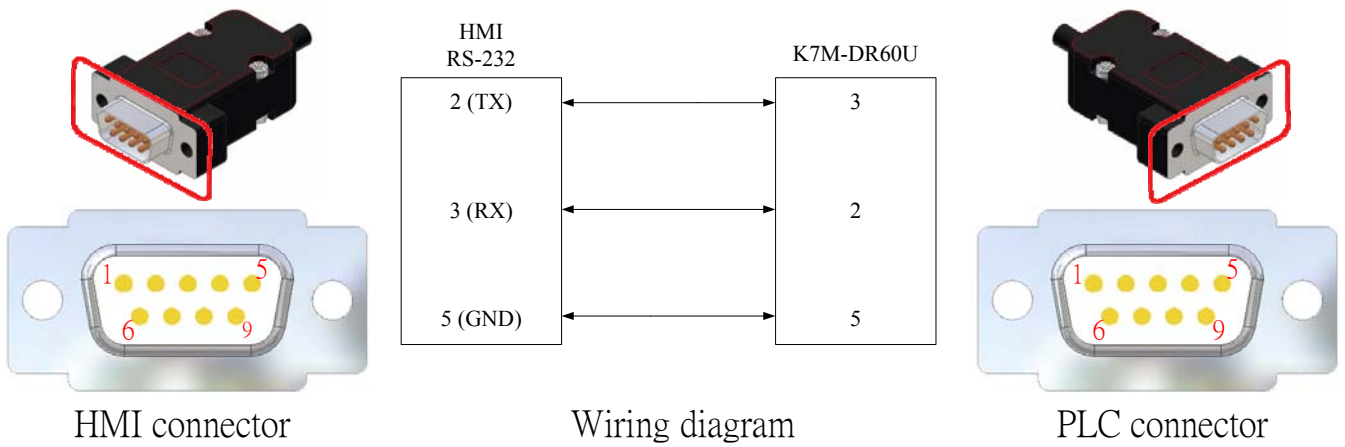

Figure 2-1-53: RS-232 connection

The mode of connection as shown in figure 2-1-54 supports the C-net protocol.

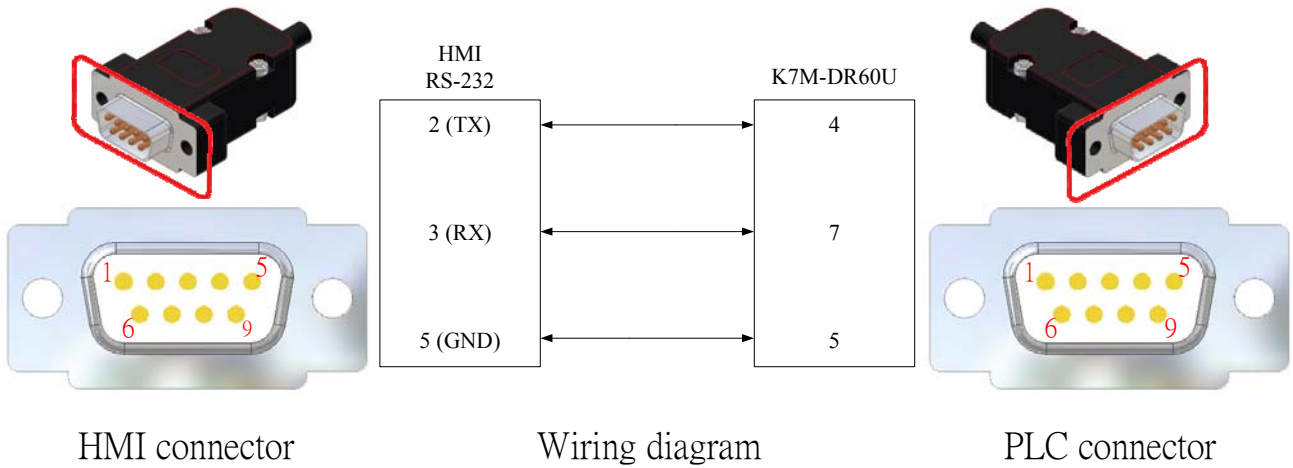

Figure 2-1-54: RS-232 connection

RS-485 is connected as shown in figure 2-1-55. The mode of connection supports the C-net protocol.

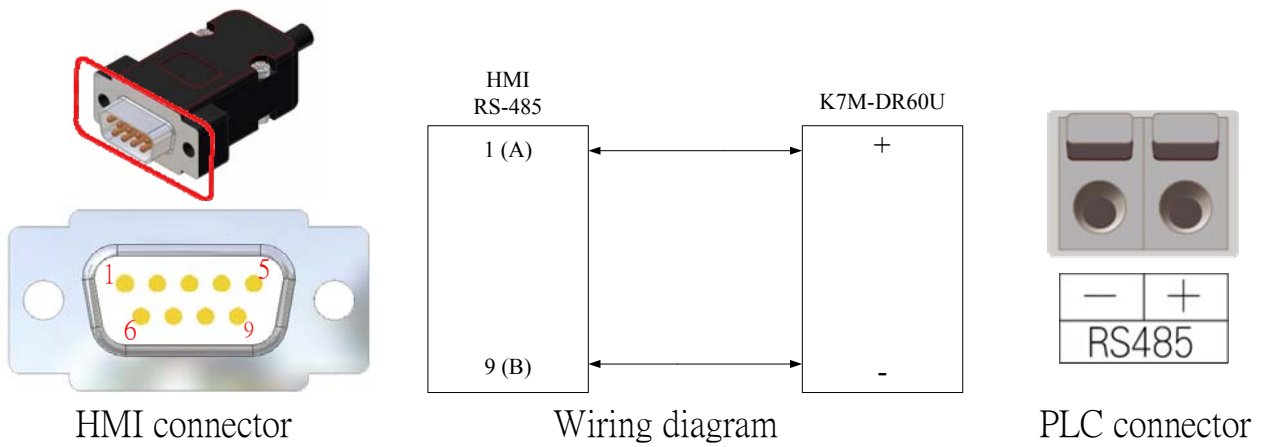

Figure 2-1-55: RS-485 connection

Devices are described as follows:

Device name	Type	Range
T	Bit device	0~255
C		0~255
P	Word device	0~63
M		0~191
L		0~63
K		0~31
F		0~63
D		0~9999
TV		0~255
CV		0~255

w. A&D Weight Indicator

RS-485 is connected to AD-4401 as shown in figure 2-1-56.

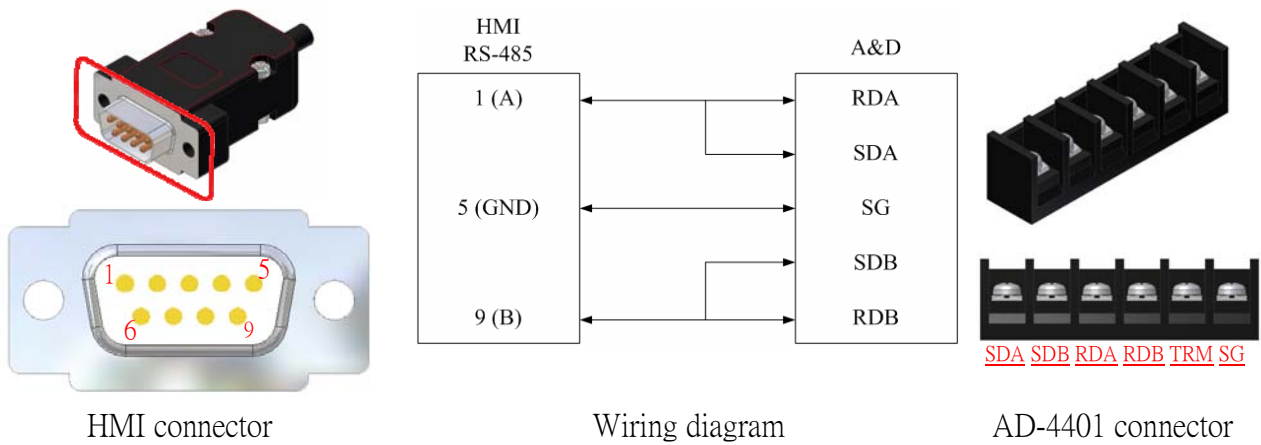

Figure 2-1-56: RS-485 connection

The following table lists AD-4401 parameter settings. Users can set parameters according to test requirements.

COM interface	Baud rate (Bps)	Baud rate (Bps)	Check code	Data bit	PLC station
RS485	9600	Even	7	1	1

Devices are described as follows:

Bit Device	
Device name	Item
ZR	Zero Range
Udr	Under
Ovr	Over
FF	Full Flow
MF	Medium Flow
DF	Dribble Flow
DGO	Discharge gate open
BF	Batch finish
DTW	Delete Total
MGW	Make Gross

MNW	Make Net
MZW	Make Zero
MTW	Make Tare
CTW	Clear Tare
BBW	Begin Batch
BDW	Discharge
HBW	Halt Batch
STW	storage area Write SS Command code

Word Device (32bits)	
Device name	Item
SF	Final
SFF	Free Fall
SPr	Preliminary
SOP	Option Preliminary
SOL	Over Limit
SUL	Under Limit
SZB	Zero Band
RW	Weight
RF	Weight Result
RT	Accumuladte Weight
RTC	Accumuladte count
RB	Weight sequence status
SFW	Final (storage area)
FFW	Free Fall (storage area)
PrW	Preliminary (storage area)
OPW	Option Preliminary (storage area)
OLW	Over Limit (storage area)
ULW	Under Limit (storage area)
ZBW	Zero Band (storage area)

## x. ModBus

Figure 2-1-57 shows the way setting ModBus communication device. The system default read command is Model and the system default write command is Auto. HMI will automatically judge read command and write command. Users can set their special conditions according to their requirements.

ModBus communication device setting				
Type	Description	Command		Description
MODBUS-RTU-MASTER	Device number input keyboard is decimal system	Read	Model	Supports group read
MODBUS-RTU-MASTER-Tem	Device number input keyboard is decimal system (For Shihlin FA products, use this type.)		Mode2	Not support group read
MODBUS-ASCII-MASTER	Device number input keyboard is decimal system	Write	Auto	Supports commands 0x06 and 0x10
MODBUS-RTU-MASTER-16	Device number input keyboard is hexadecimal		0x06	Only supports command 0x06
MODBUS-ASCII-MASTER-16	Device number input keyboard is hexadecimal		0x10	Only supports command 0x10

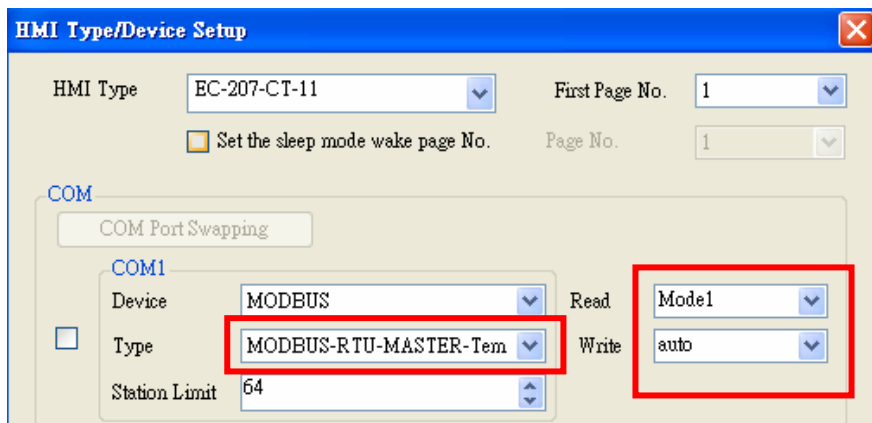

Figure 2-1-57: ModBus communication device setting

Devices are described in the following table:

Device name	Type	Decimal address range	Hexadecimal address range	Corresponding command code
MBR	Bit read-only device	0~65535	0~FFFF	0x02
MB	Bit device			0x01,0x05
MWR	Word read-only device			0x04
MW	Word device			0x03,0x06,0x10





● The Shihlin temperature controller shall be connected to RS-485 as shown in figure 2-1-58.

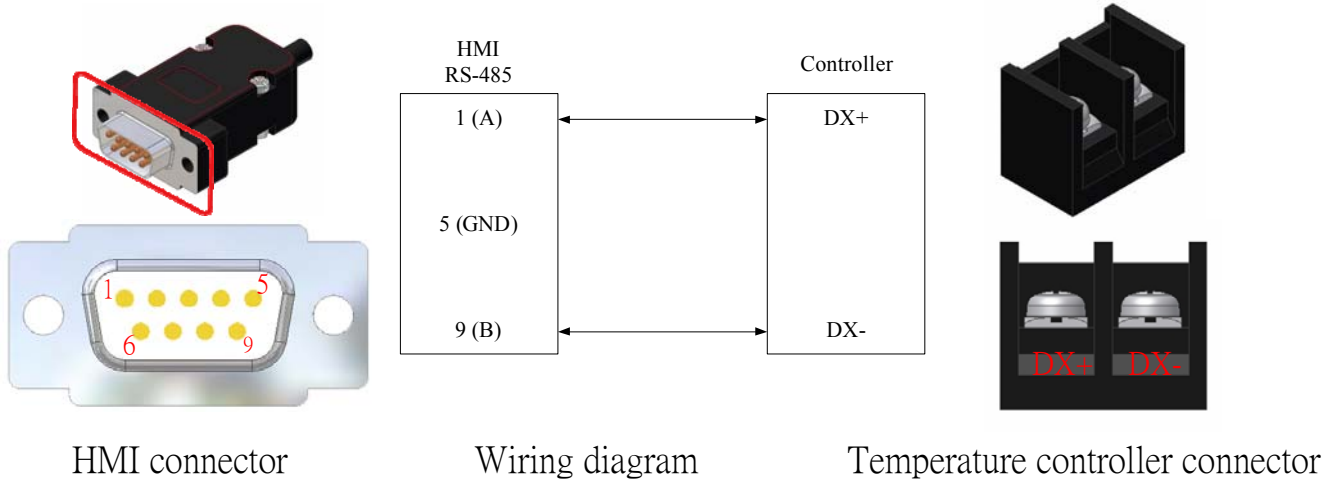

Figure 2-1-58: RS-485 connection

● The Shihlin servo driver shall be connected to RS-232 as shown in figure 2-1-59.

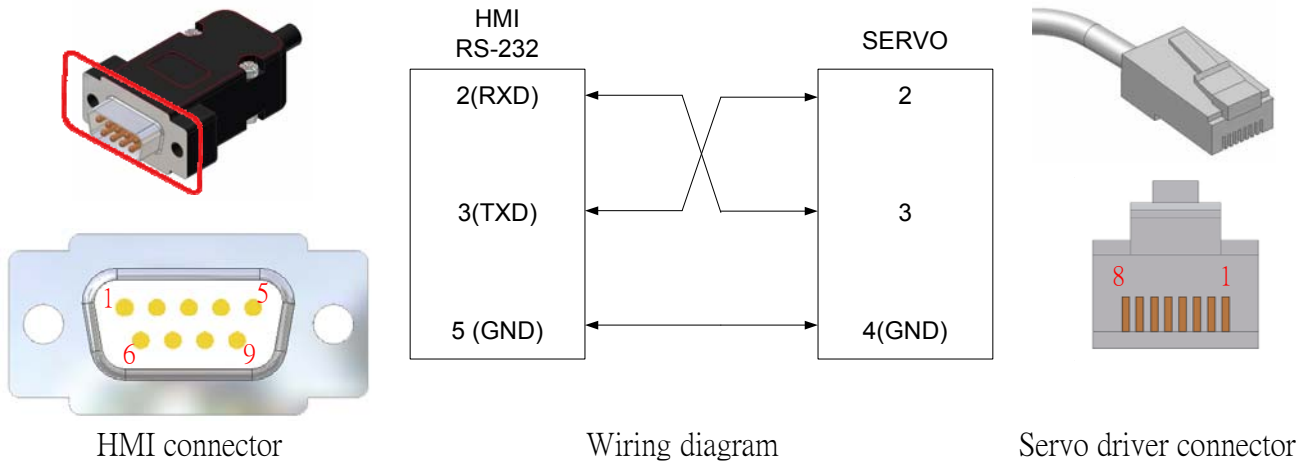

Figure 2-1-59: RS-232 connection

RS-485 is connected as shown in figure 2-1-60.

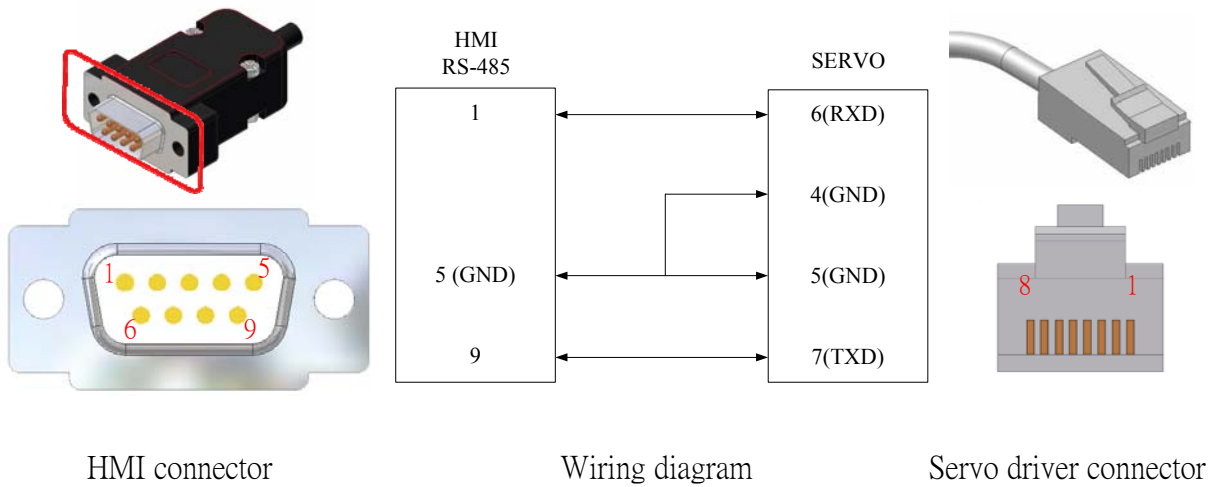

Figure 2-1-60: RS-485 connection

The following table lists parameter settings for Shihlin servo driver. Users can set parameters according to test requirements.

COM interface	Device type	Baud rate (Bps)	Check code	Data length	Stop bit	CR/LF select
RS232	MODBUS-ASCII-MASTER	9600	None	7	2	None
RS485	MODBUS-RTU-MASTER-Tem	38400	None	8	2	None

## y. Ethernet

To set up the communication protocol, click the **System** manual, and select

**HMI Type/Device Setup...** to change HMI Device / Model.

### y.1. FX3U-ENET network module connected to FX3U series

HMI editor software's IP address is set as shown in figure 2-1-61.

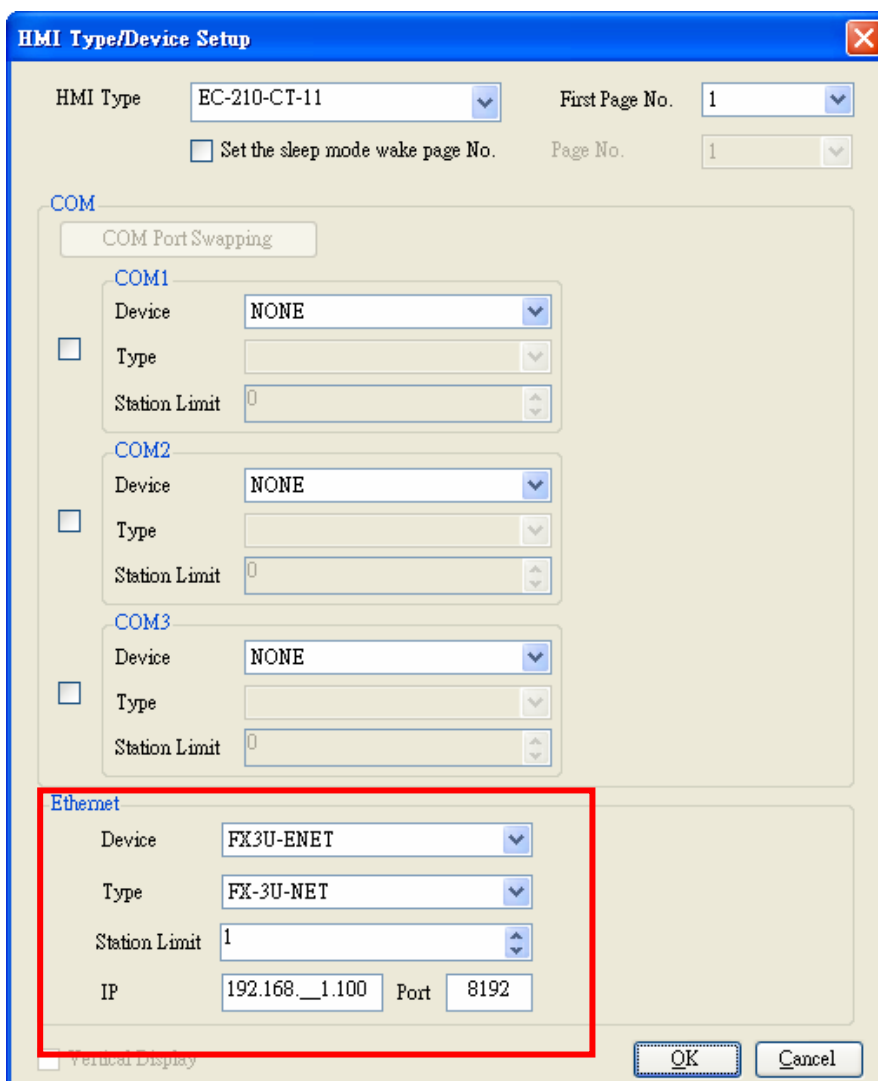

Fig. 2-1-61 Network Setup

Execute the 『FX3U-ENET-L Configuration Tool』 software and set it as shown in figure 2-1-62.

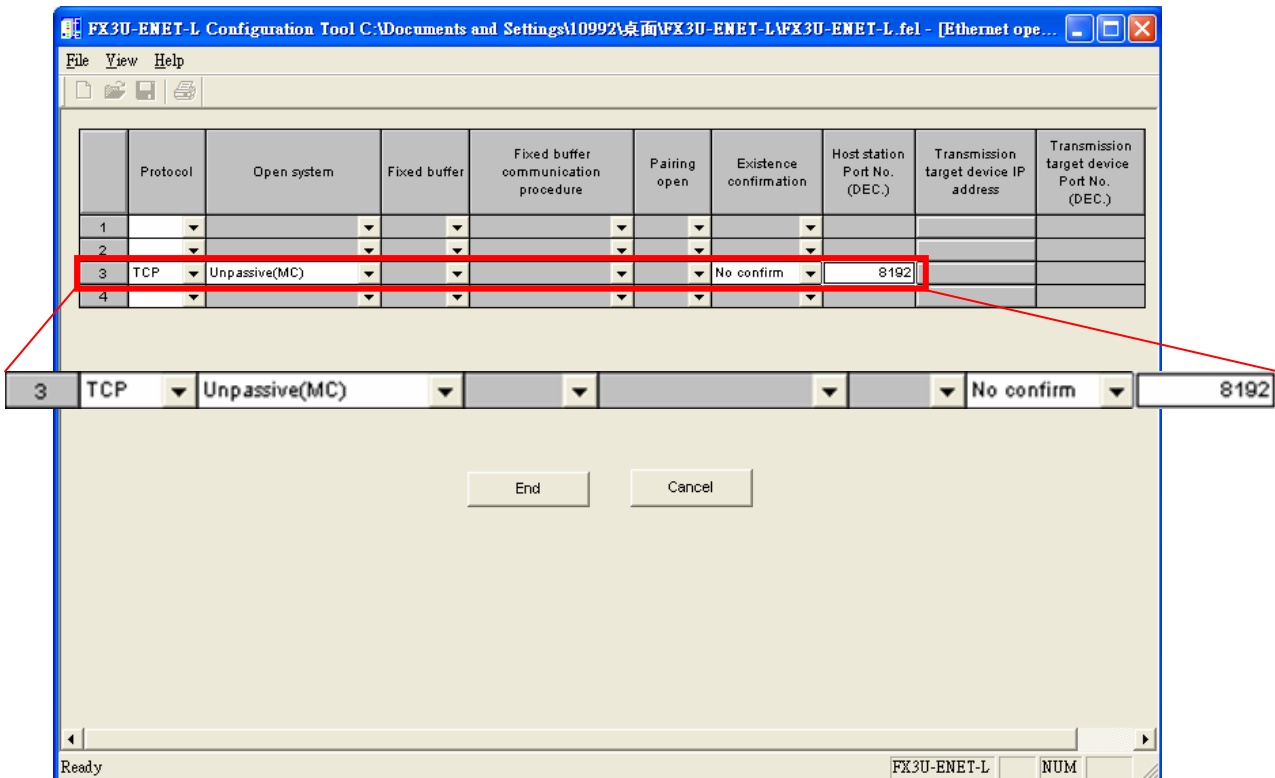
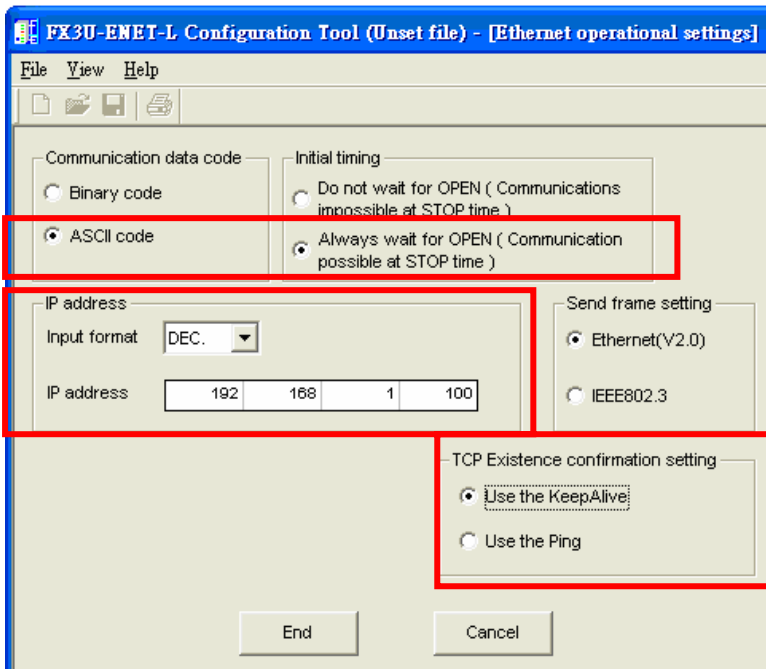
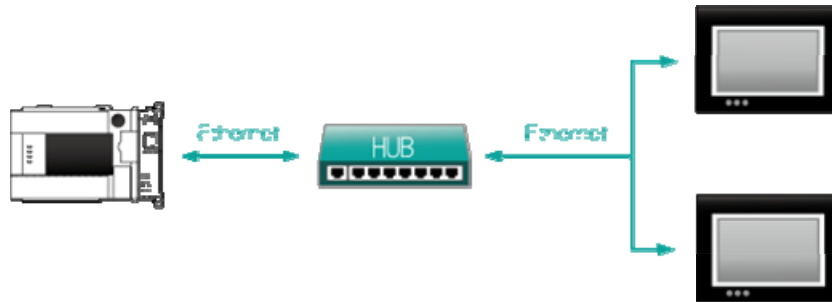

Figure 2-1-62: FX3U-ENET-L network module communication setup

## y.2. FX3U-ENET-ADP network module connected to FX3U series(UDP communication protocol)

The following is the FX3U Series External FX3U-ENET-ADP connecting two Shihlin HMI setting examples.

Connection diagram:



HMI editor software' s setting :

HMI No. 1:

Ethernet	
Device	FX3U-ENET-UDP
Type	FX-3U-NET-UDP
Station Limit	1
IP	192.168.__1.__30
Port	5001

Device setup

HMI Parameter Setup			
System	Serial	Ethernet	Power
IP Address	192.168.__1.__45		
Subnet Mask	255.255.255.__0		
Default gateway	192.168.__1.__0		

Parameter setup

HMI No. 2:

Ethernet	
Device	FX3U-ENET-UDP
Type	FX-3U-NET-UDP
Station Limit	1
IP	192.168.__1.__30
Port	5002

Device setup

HMI Parameter Setup			
System	Serial	Ethernet	Power
IP Address	192.168.__1.__48		
Subnet Mask	255.255.255.__0		
Default gateway	192.168.__1.__0		

Parameter setup

Communication setup of Mitsubishi PLC FX3U-ENET-ADP network module(use the GX Developer software):

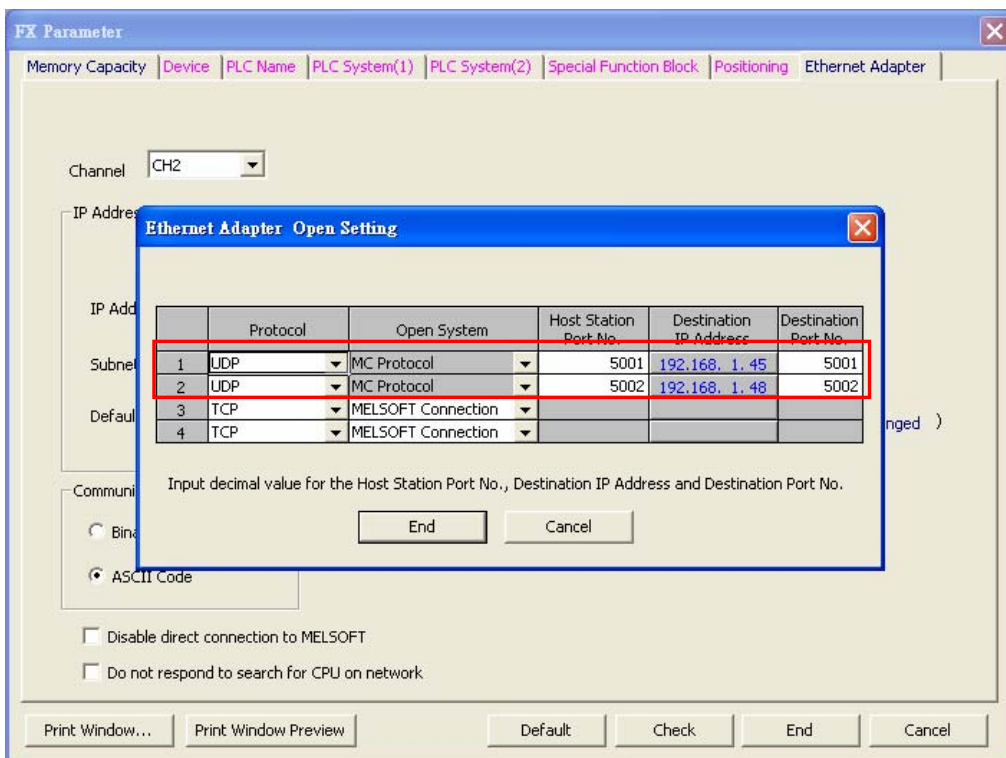
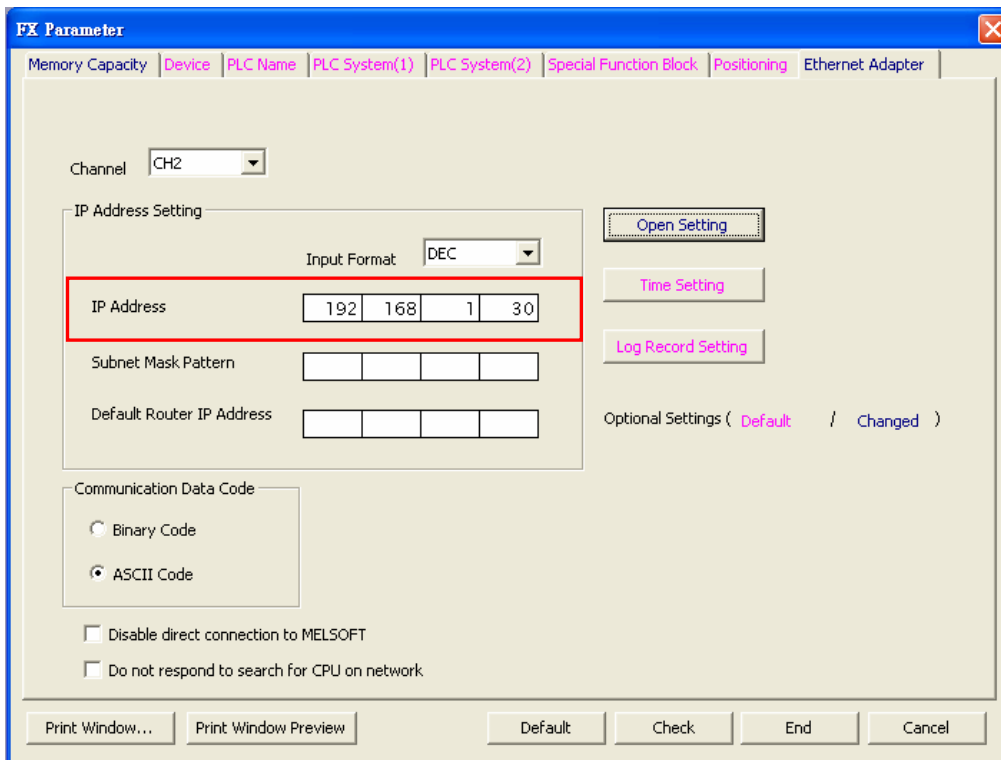

### y.3. QJ71E71-100 network module connected to Mitsubishi Q series or L series PLC

HMI editor software's IP address is set as shown in figure 2-1-63.

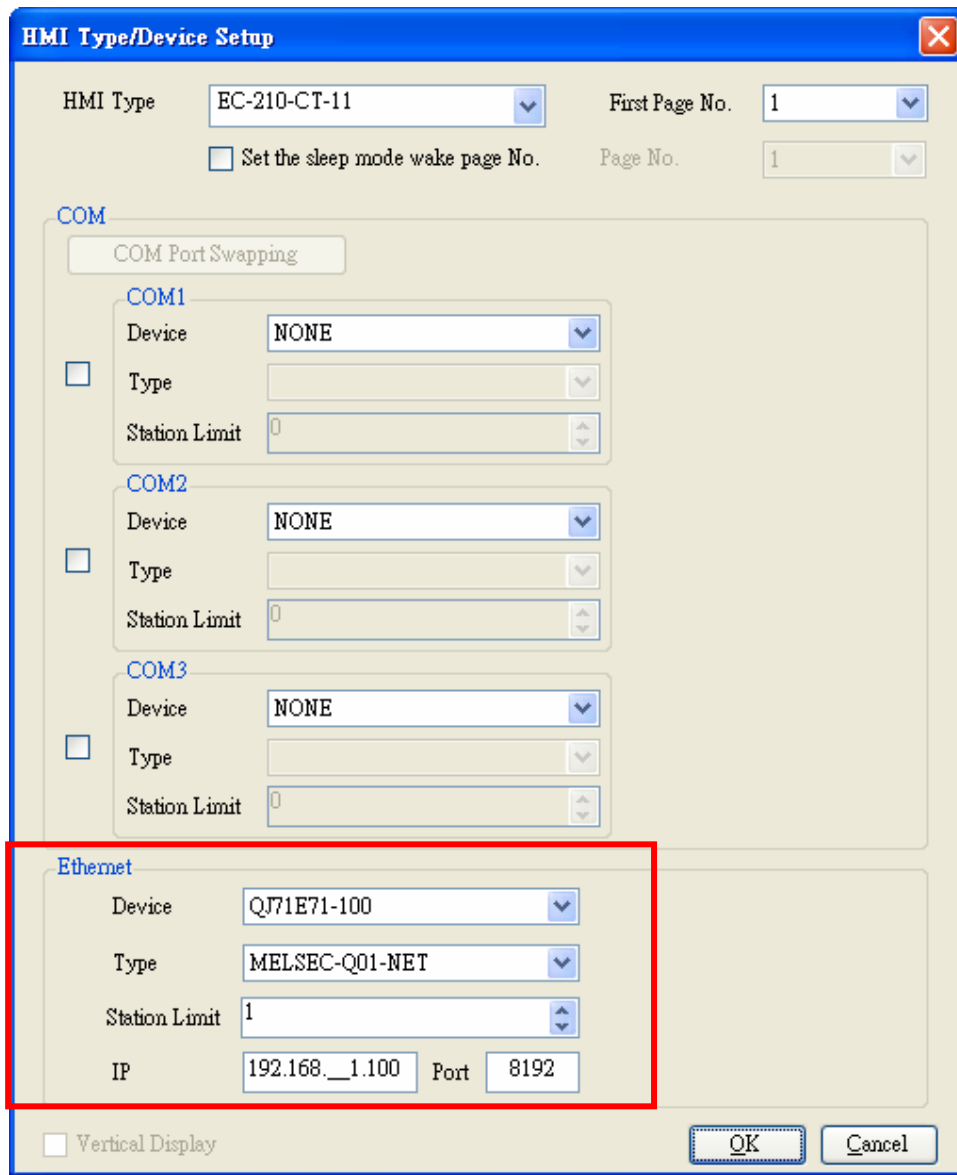

Figure 2-1-63: Network setup

Communication setup of Mitsubishi PLC network module:

If you want to set the Mitsubishi PLC internal network, you should start GX Developer and select your needed device. You can set the network on the left of the window, as shown in figure 2-1-64.



Figure 2-1-64: Network parameter setup

You should set the network type, starting I/O number, network number, group number and station number, etc. Details are as shown in figure 2-1-65.

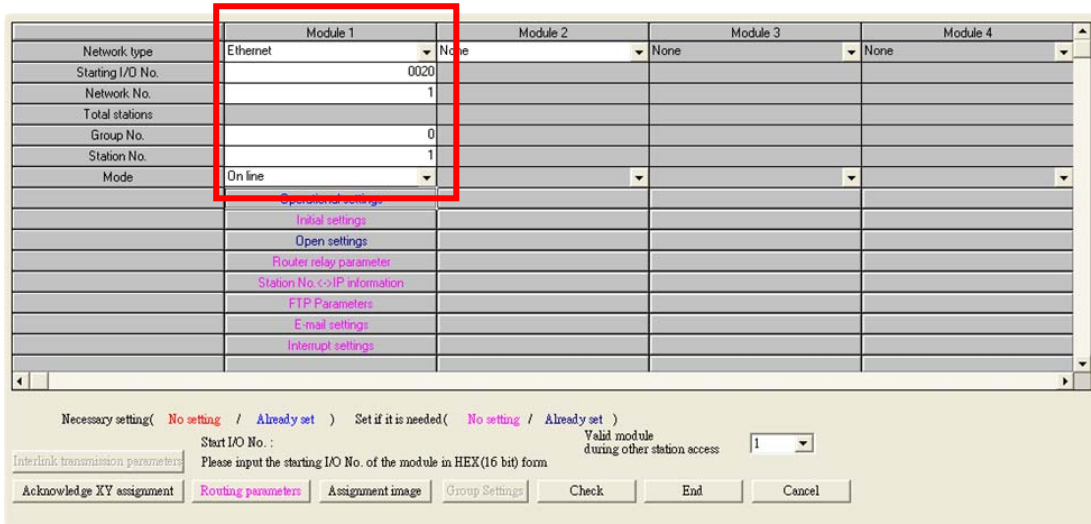

Figure 2-1-65: Network setup



You finally need to set operation and start the setup. Detailed parameters are set as shown in figure 2-1-66.

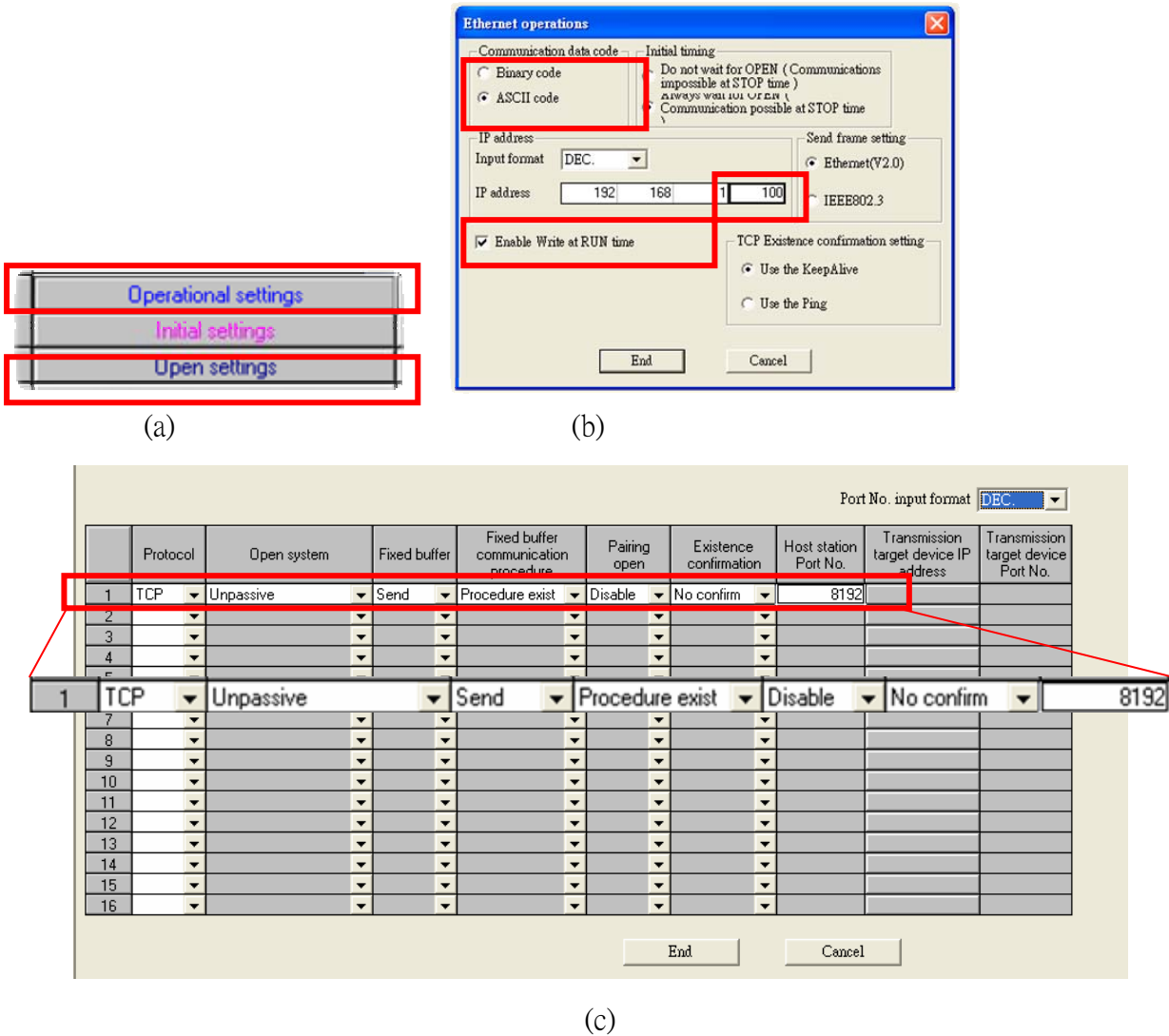

Figure 2-1-66: Other parameters (a)Module setup (b) Operation setup (c) Open setup

#### y.4. Communication setup of Mitsubishi Q series or L series CPU built-in network module

HMI editor software's IP address is set as shown in figure 2-1-67.

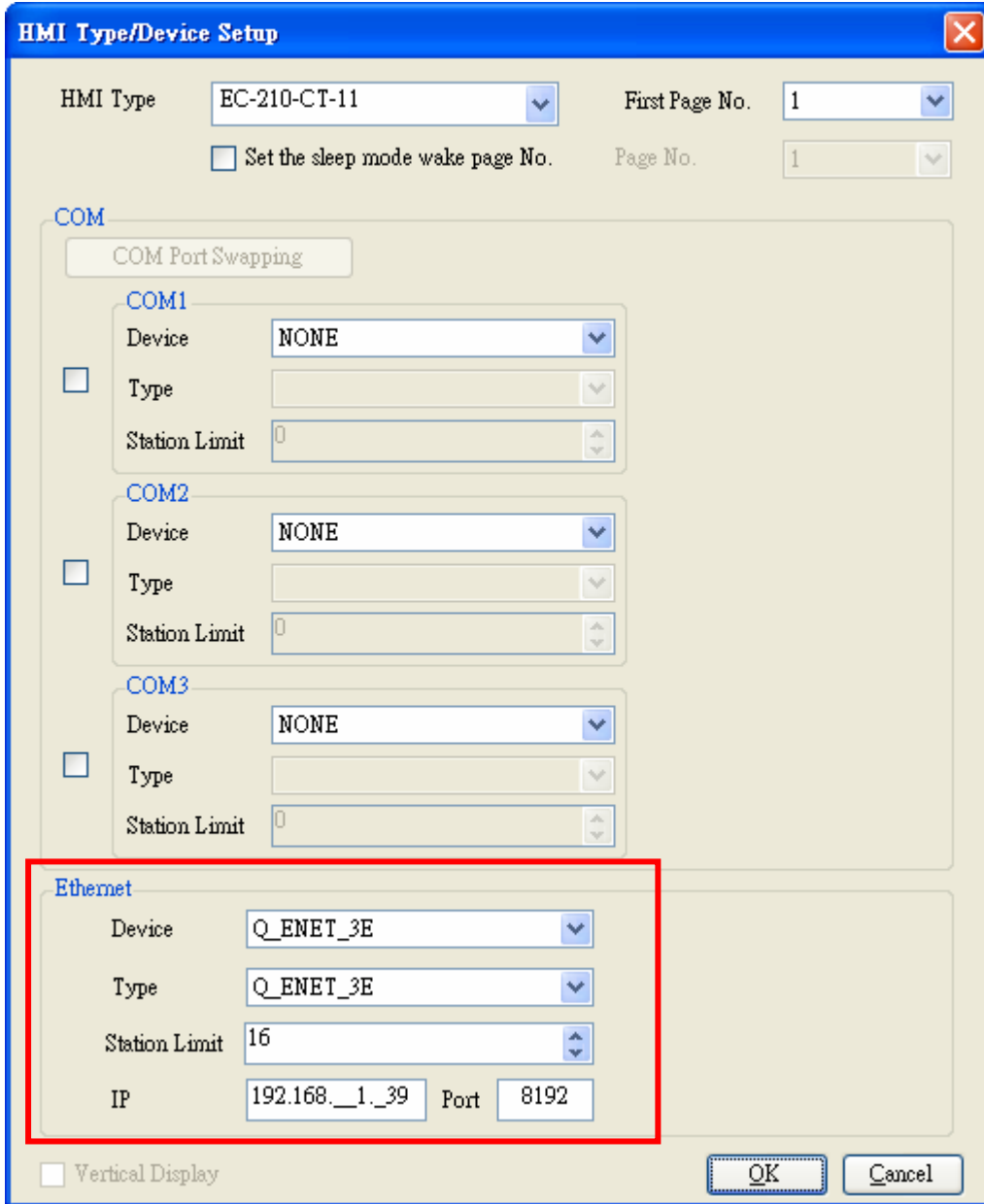

Figure 2-1-67: Network setup

Start the GX Developer and set the network on the left of the window, as shown in figure 2-1-68.

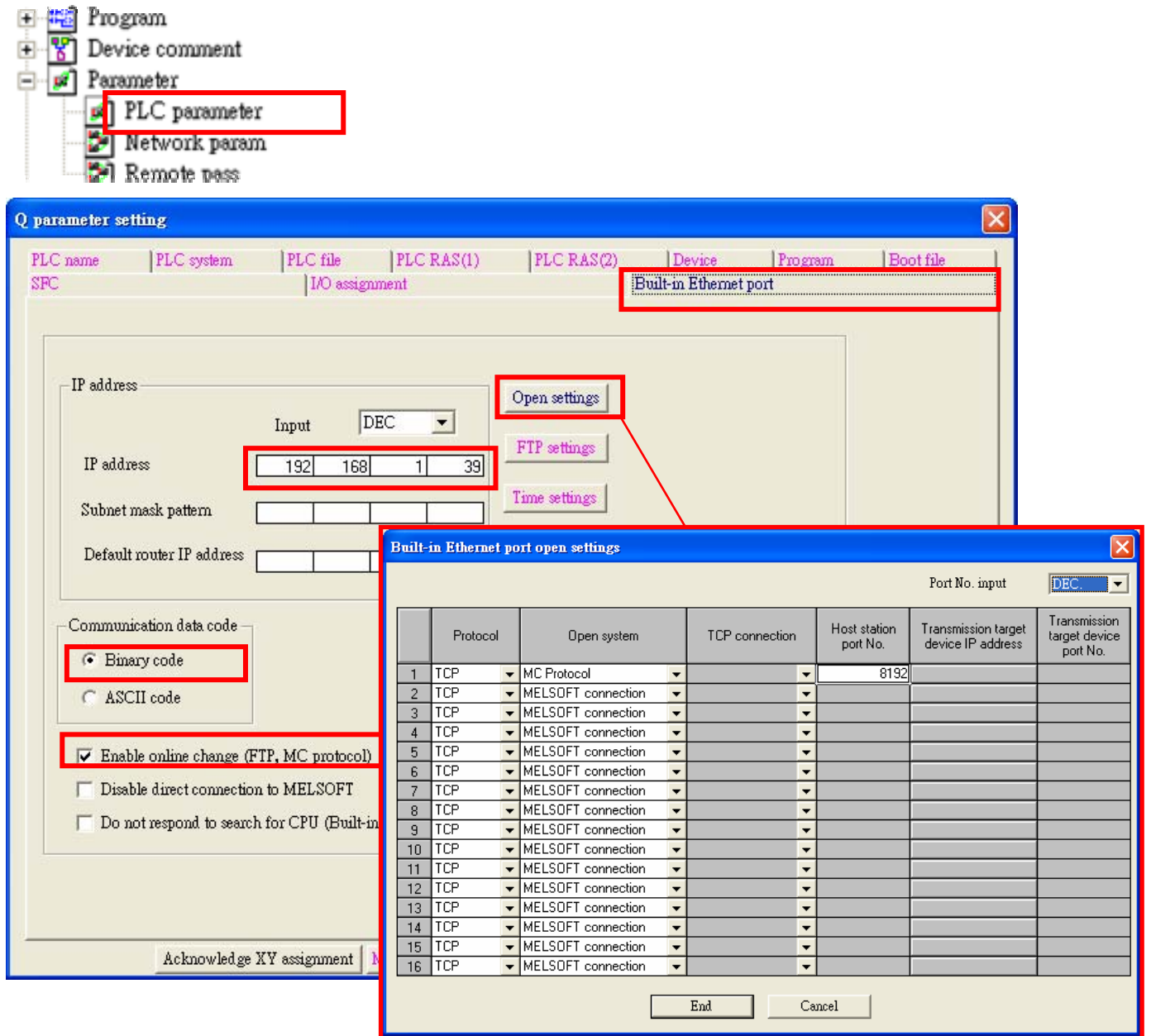
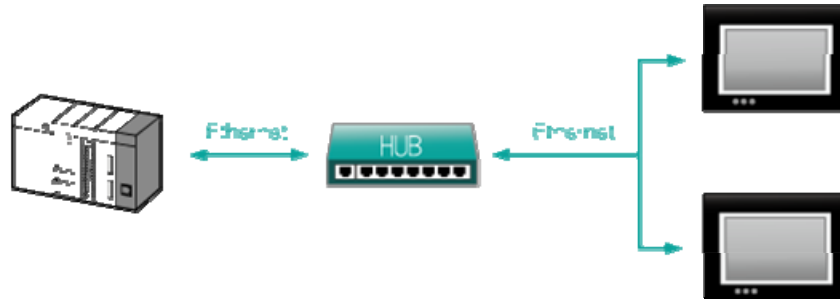

Figure 2-1-68: Network parameter setup

## 5.5. Communication setup of Mitsubishi QJ71E71-100 built-in network (UDP communication protocol)

The following is the QJ71E71-100 connecting two Shihlin HMI setting examples.

Connection diagram:



HMI editor software's setting :

HMI No. 1:

Ethernet	
Device	Q_ENET_3E_UDP
Type	Q_ENET_3E_UDP
Station Limit	16
IP	192.168.__1.__30
Port	5001

Device setup

HMI Parameter Setup			
System	Serial	Ethernet	Power
IP Address	192.168.__1.__10		
Subnet Mask	255.255.255.__0		
Default gateway	192.168.__1.__0		

Parameter setup

HMI No. 2:

Ethernet	
Device	Q_ENET_3E_UDP
Type	Q_ENET_3E_UDP
Station Limit	16
IP	192.168.__1.__30
Port	5001

Device setup

HMI Parameter Setup			
System	Serial	Ethernet	Power
IP Address	192.168.__1.__20		
Subnet Mask	255.255.255.__0		
Default gateway	192.168.__1.__0		

Parameter setup

Communication setup of Mitsubishi PLC QJ71E71-100 built-in network module(use the GX Developer software):

The screenshot shows the 'Network parameter' dialog box with 'Ethernet/CC IE/MELSECNET' selected. Below it, a table lists settings for 'Module 1'. A red box highlights 'Operational settings', 'Initial settings', and 'Open settings' in the table. A second dialog box, 'Ethernet operations', is also open, showing communication data code, IP address, and timing settings.

Module 1	
Network type	Ethernet
Starting I/O No.	0000
Network No.	1
Total stations	
Group No.	0
Station No.	1
Mode	Online
	Operational settings
	Initial settings
	Open settings
	Route/relay parameter
	Station No <-> IP information
	FTP Parameters
	E-mail settings
	Interrupt settings

Port No. input format: DEC

	Protocol	Open system	Fixed buffer	Fixed buffer communication procedure	Pairing open	Existence confirmation	Host station Port No.	Transmission target device IP address	Transmission target device Port No.
1	UDP		Receive	Procedure exist	Enable	No confirm	5001	192.168. 1. 10	5001
2	UDP		Send	Procedure exist	Enable	No confirm	5001	192.168. 1. 10	5001
3	UDP		Receive	Procedure exist	Enable	No confirm	5001	192.168. 1. 20	5001
4	UDP		Send	Procedure exist	Enable	No confirm	5001	192.168. 1. 20	5001
5									
6									
7									
8									
9									
10									
11									
12									
13									
14									
15									
16									

## y.6. Communication setup of Mitsubishi QnUDECPU built-in network (UDP communication protocol)

The following is the QnUDECPU connecting two Shihlin HMI setting examples.

Connection diagram:

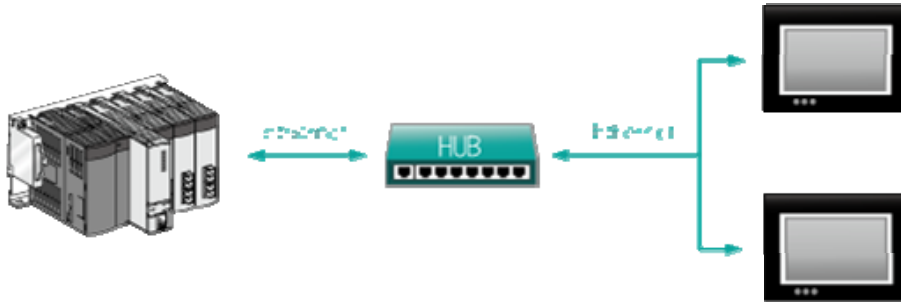

HMI editor software's setting :

HMI No. 1:

Ethernet	
Device	Q_ENET_3E_UDP
Type	Q_ENET_3E_UDP
Station Limit	16
IP	192.168.__1__30
Port	5010

Device setup

HMI Parameter Setup			
System	Serial	Ethernet	Power
IP Address	192.168.__1__45		
Subnet Mask	255.255.255.__0		
Default gateway	192.168.__1__0		

Parameter setup

HMI No. 2:

Ethernet	
Device	Q_ENET_3E_UDP
Type	Q_ENET_3E_UDP
Station Limit	16
IP	192.168.__1__30
Port	5011

Device setup

HMI Parameter Setup			
System	Serial	Ethernet	Power
IP Address	192.168.__1__48		
Subnet Mask	255.255.255.__0		
Default gateway	192.168.__1__0		

Parameter setup

Communication setup of Mitsubishi PLC QnUDECPU built-in network module(use the GX Developer software):

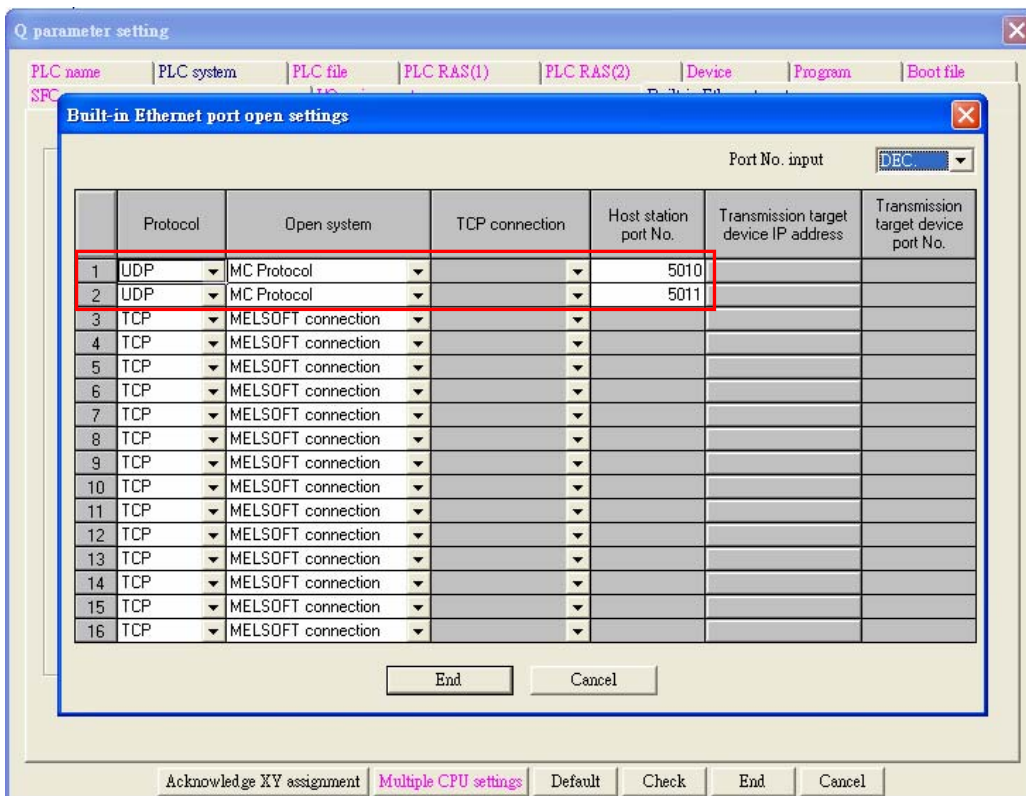
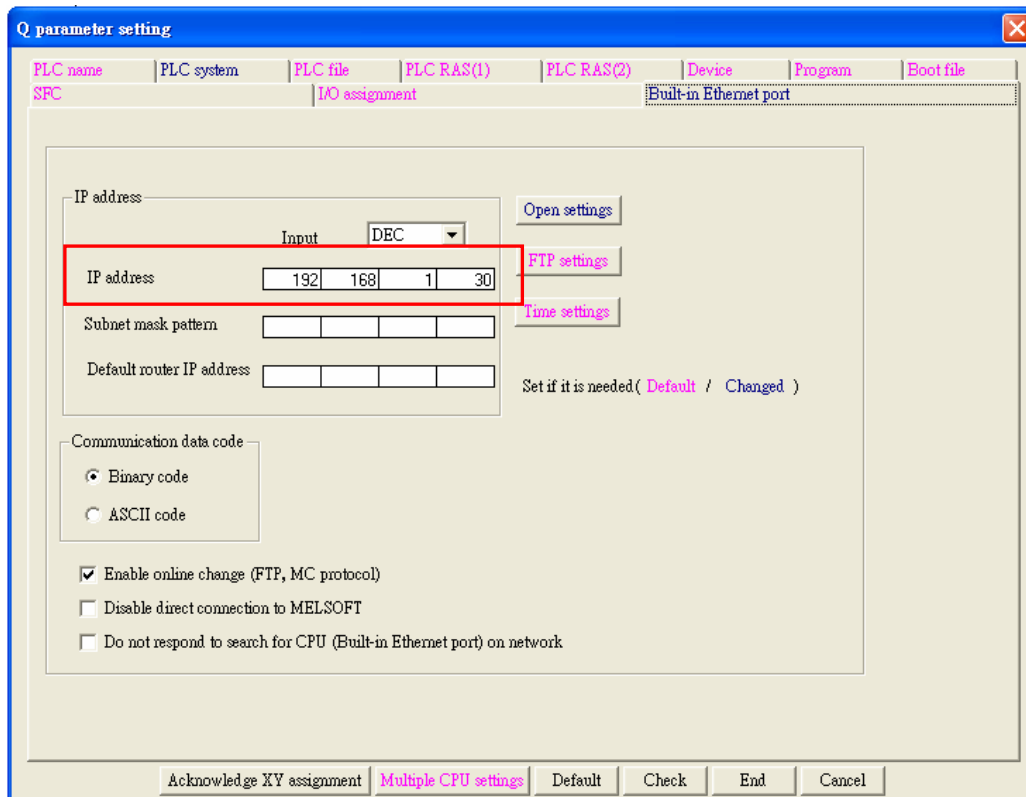

## 7. MODBUS-TCP

HMI editor software's IP address is set as shown in figure 2-1-69.

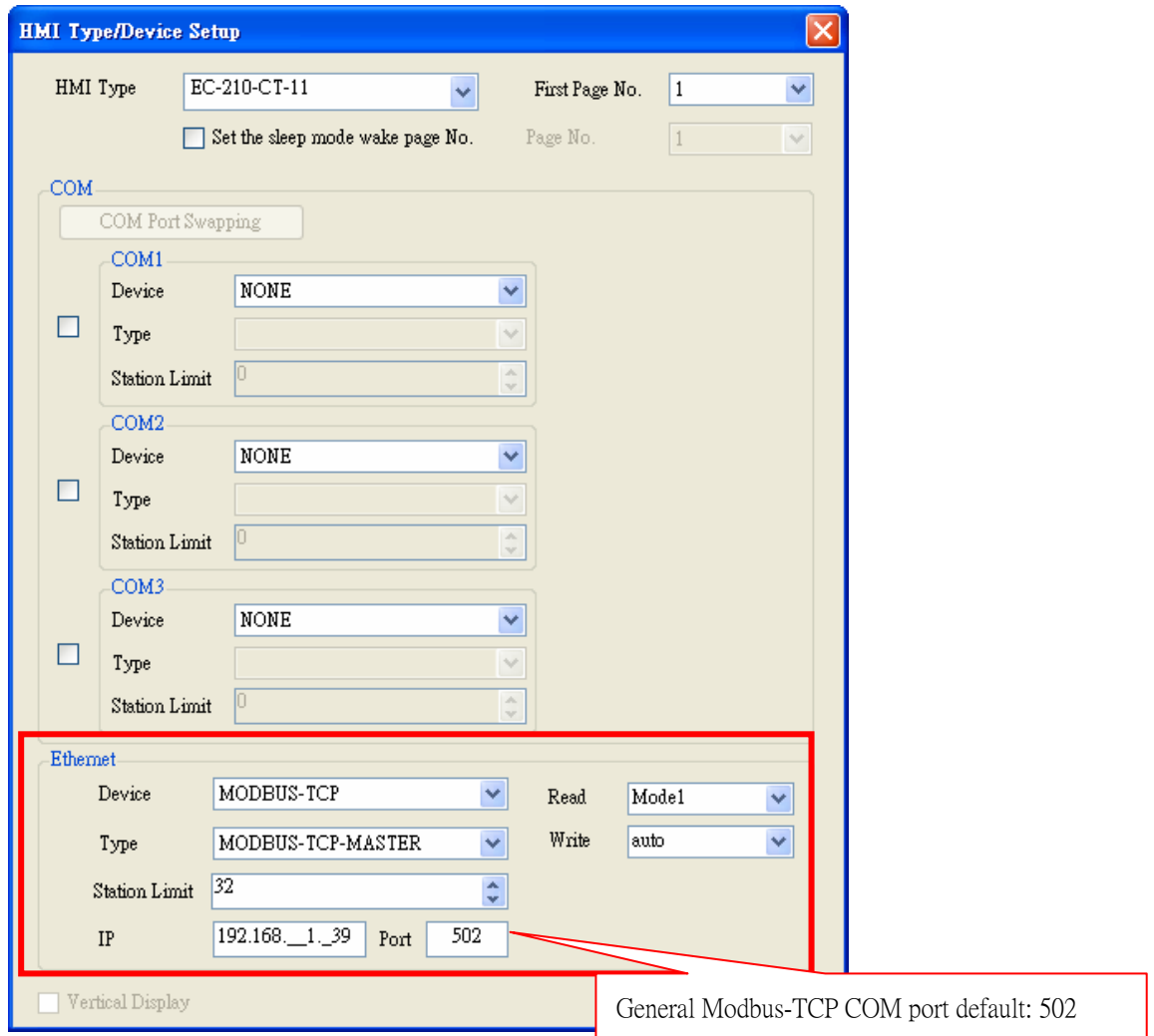
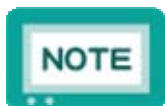

Figure 2-1-69: Network setup



- The HMI default network address is 192.168.1.45. Users can define their own address; the Ethernet host IP address is also user-definable, if only it is different from HMI's default IP address.
- For network related settings, please refer to the manuals of the devices.
- If Ethernet communication still does not work after setting according to the aforesaid descriptions, check if HMI station number is 0. The Ethernet only works as HMI station number is 0.



## y.8.OMRON-TCP

The following is the OMRON\_CJ2M TCP connecting Shihlin HMI setting examples.

Ethernet

裝置	OMRON-TCP		
型號	OMRON-TCP		
局號上限	16		
IP	192.168.250.__1	Port	9600

The CP1W- MODTCP61 is assigned a default IP address of 192.168.250.node address (01~FE)  
Baud rate : 9600

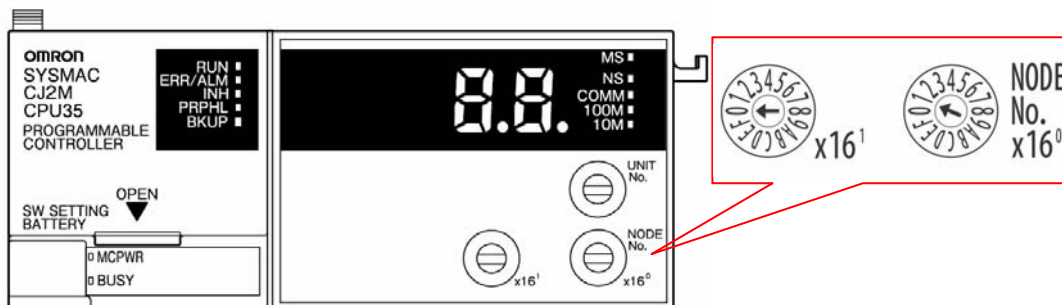

The CP1W- MODTCP61 IP address setup

## z. Barcode

Let's take ARGOX made AS-8150 barcode scanner for example. RS-232 is connected as shown in figure 2-1-70.

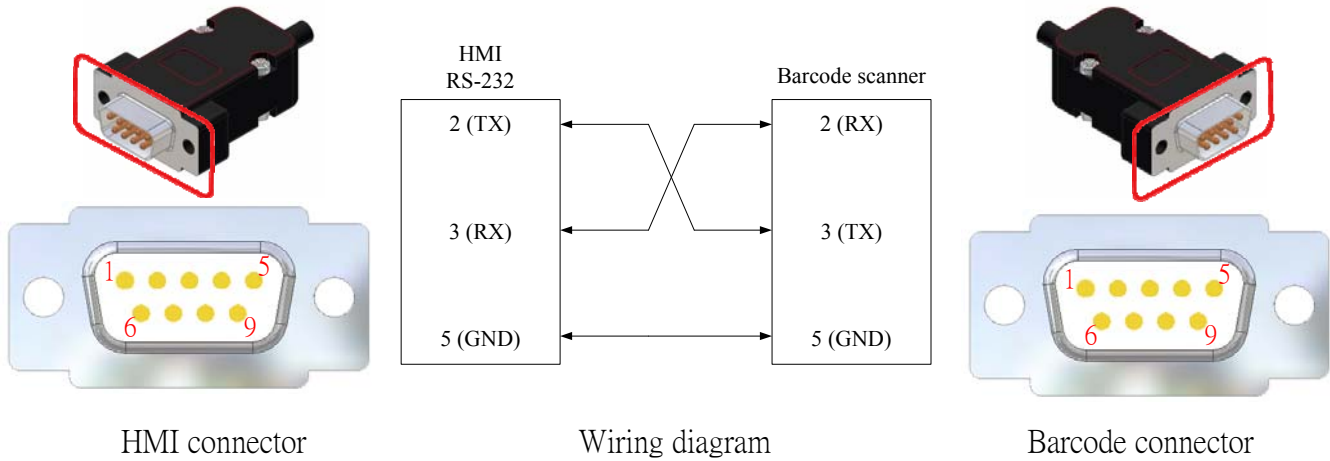

Figure 2-1-70: Connection of Barcode scanner



- Use COM1/ COM3 to connect Barcode scanner to Shihlin HMI (COM1 and COM3 select a port to use).
- For detailed barcode setting, see [EC series software manual](#).
- The use of Barcode functions must refer to Barcode user manual so as to correctly set communication parameters for Barcode scanner.

### aa. Micro printer

Let's take SIUPO made E series micro printer for example. RS-232 is connected as shown in figure 2-1-71.

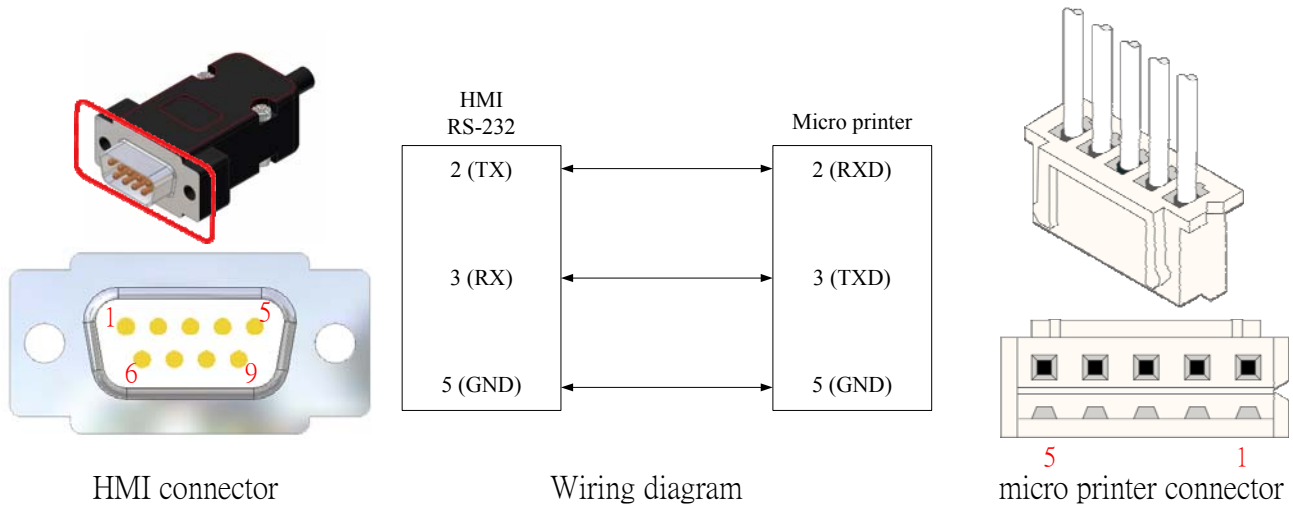

Figure 2-1-71: Connection of micro printer

#### NOTE

- For detailed ASCII command setting, see [EC series software manual](#).
- The use of Micro Printer functions and communication parameters setting must refer to Micro Printer user manual.

## 2.2. HMI Communications Setup

To make connection to various brands of PLC, please refer to the following Table 2-2-1 for the settings and set up the connection in HMI.

Table 2-2-1 HMI Communications Setup

Brands	Items	Baud Rates (bps)	Data Length (Bits)	Parity	Stop Bit (Bit)	PLC Station Number
	Mitsubish FX Series	9600	7	Even	1	N/A
	Delta DVP Series					1
	Fatek FB Series				(Initial Settings)	
	OMRON				2	
Mitsubishi	A Series	19200 38400 57600 115200	8	Odd	1	N/A
	Q Series					
	QnA Series					
Panasonic	FP0	9600	8	Odd	1	N/A
	FP0R					
	FP-e					
	FPE					
	FP-X					
	FP2					
	Vigor V Series	19200	7	Even	1	N/A
SIEMENS	S7-200	9600	8			
	S7-300	38400		Odd		
Allen-Bradley	MicroLogix	19200	8	None	1	N/A
Schneider	TM218	19200		Even		
Xin Je	XCM	19200	None			
Keyence	KV Series	9600				
LS	Master-K120S	38400	None			
	Master-K-CNET	19200				

### 2.3. Many to One

Multiple HMI, up to 8 units, can be used to simultaneously monitor a single unit of the FA equipment. For the connection, network cable of cross-over twisted pair is required, as shown in Figure 2-3-1.

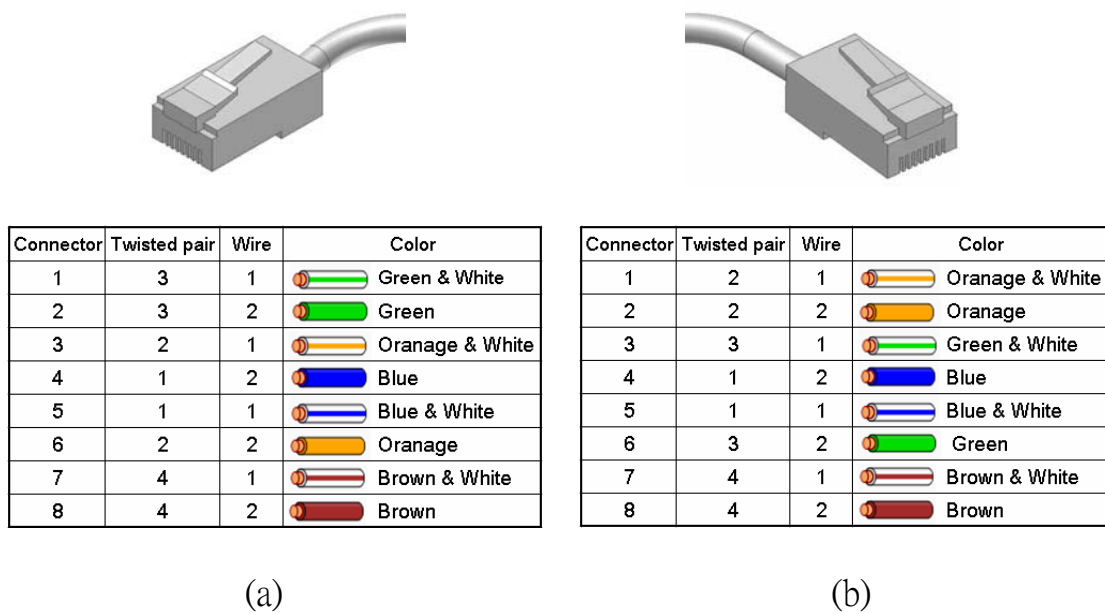



Fig. 2-3-1 Network Cable (a) T568A (b) T568B

To set 8-to-1 monitoring, return to the system screen and click the  icon. Set the station number of the first HMI to 1, the system will then automatically establish the first HMI as sever, and orderly set the station numbers of the rest HMIs to 2~8 as clients. When the setup is done, click the save button.

Confirm the setup and send the file to the first HMI, which will then relay the file to the rest HMIs numbered 1~8, as shown in the following Figure 2-3-2.

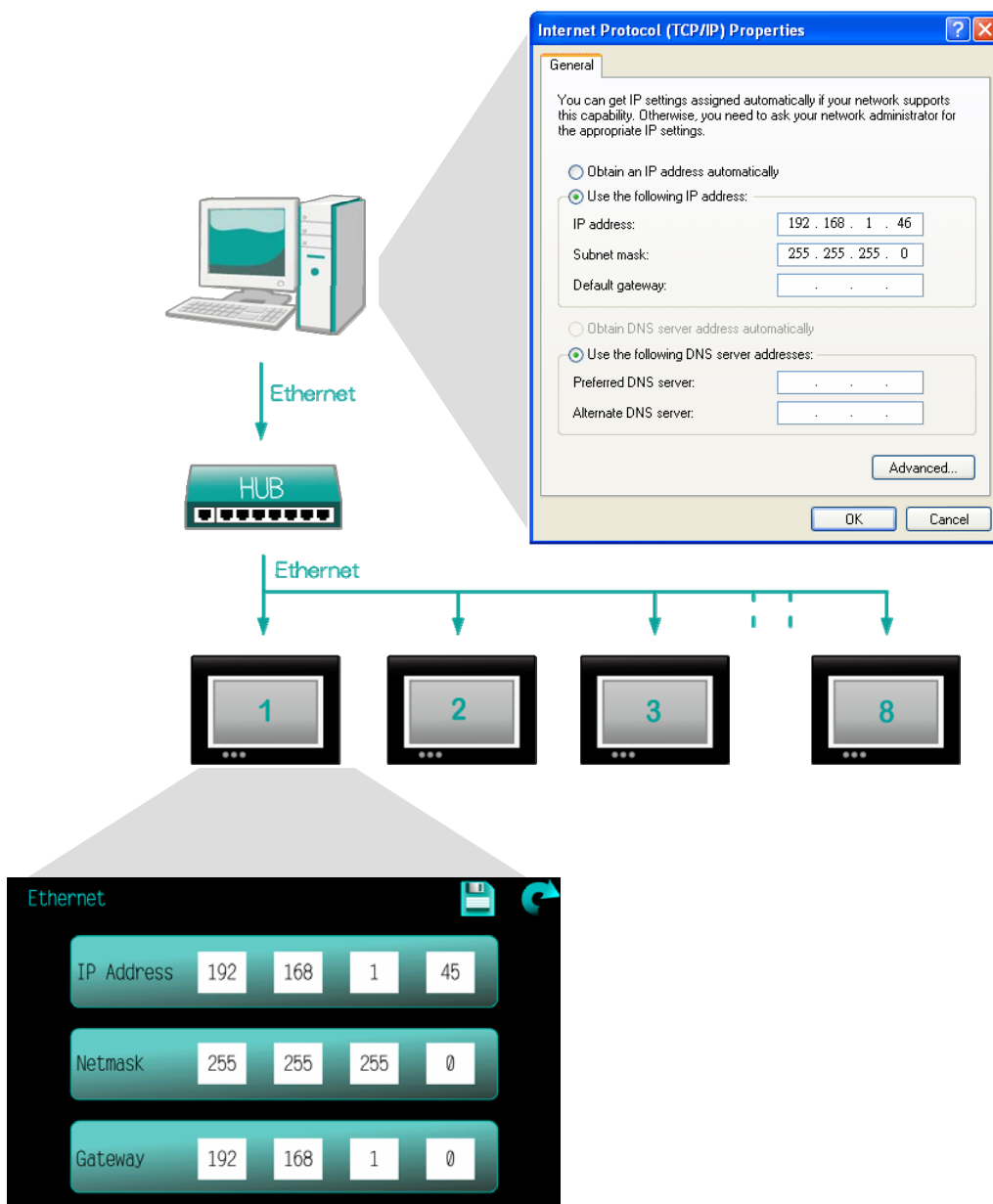



Fig. 2-3-2 8-to-1 Wiring Diagram

When use 8-to-1 function to monitor, please return to the system screen and go to the HMI office number in the . After changing the 1<sup>st</sup> HMI office number to 1, the system will automatically create a Server terminal, and after office numbers of other HMI are changed to 2~8 in sequence, it will create a Client terminal. After completion, press the save button save settings, as shown in figure 2-3-3.

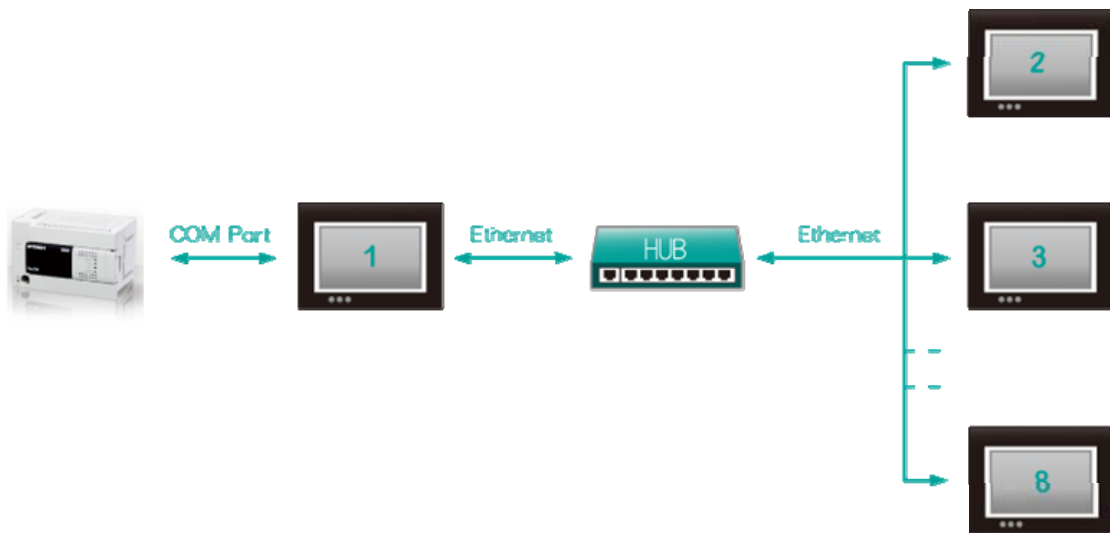

Figure 2-3-3: 8-to-1 wiring diagram

After creating the Server and Client terminals, HMI will automatically connect to both the Server and the Client terminals.



## Chapter 3 System Configurations

### 3.1. Setting Description

Please plug the power connector into a 24V power source to start the Shihlin HMI.

The following Figure 3-1-1 shows the system screen after boot.

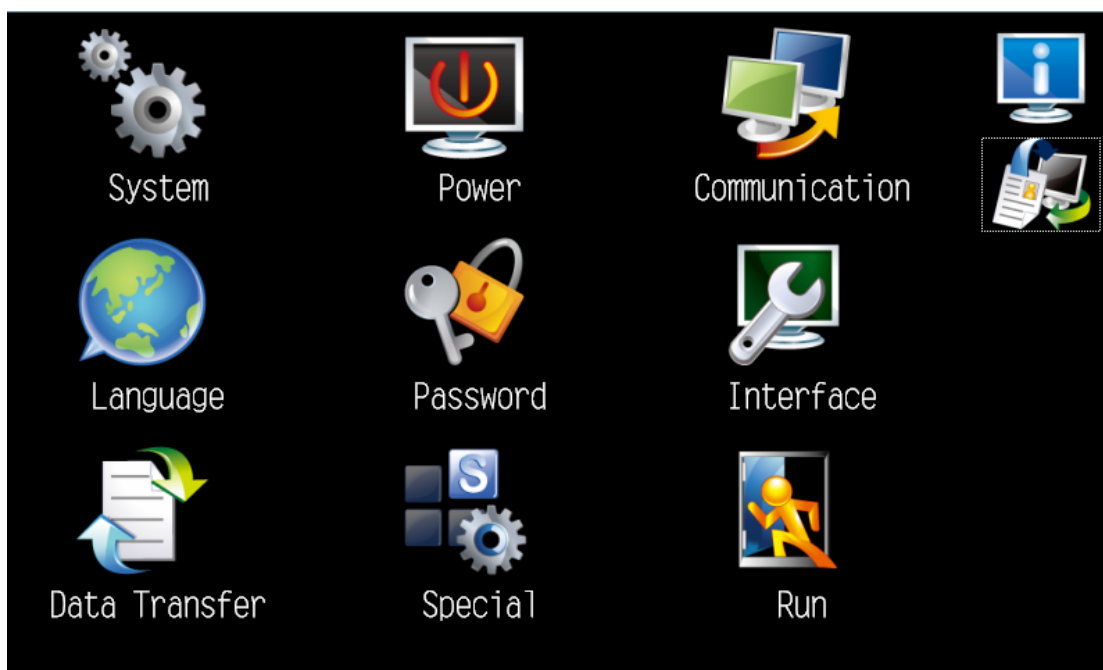

Fig. 3-1-1 System Screen

In the case of HMI within the project, When HMI within the project, the system screen will pop up a prompt window if the battery is no quantity or battery low , and confirm the date and time of the HMI when the battery is no quantity , the following Figure 3-1-2 and Figure 3-1-3.



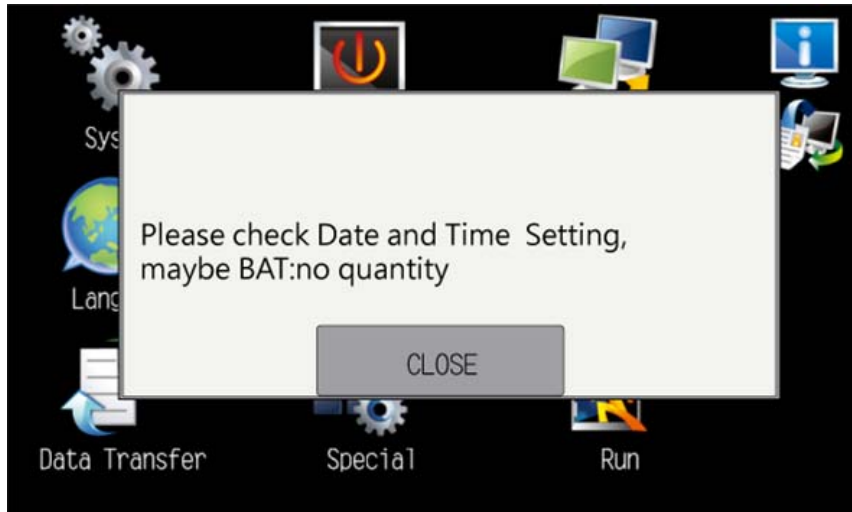



Fig.3-1-2 、 Battery is no quantity



Fig.3-1-3 、 Battery low

**NOTE**

- After the screen data is sent to the HMI, the system in subsequent boots will directly go to the execution screen.
- On the upper left corner of the execution screen, touch 5 times consecutively to get back to the system screen (If the time interval between two touches is more than five seconds, HMI will void the count.)
- When the system setup is complete, Click the  Save button will restart the execution screen.
- EC207-CT0S, EC207-CT1S models does not support non-battery prompt function and low battery prompt function.

## 3.2. System Setup

Click the system setup icon, the following items will be available, as shown in

Figure 3-2-1.

Fig. 3-2-1 System Setup



	Description	Remark
Touch Sound	Open/close touch sound	N/A
Date & Time	Adjust date & time	
Brightness	Brightness setting	
Direction	Screen vertical / horizontal display	



- After the setup is done, be sure to click the  icon to save the settings in the system.
- Direction setting function to supply the EC205-CT0A models use.



### 3.3. Power Setup

Click the power setup icon, the following items will be available, as shown in

Figure 3-3-1.

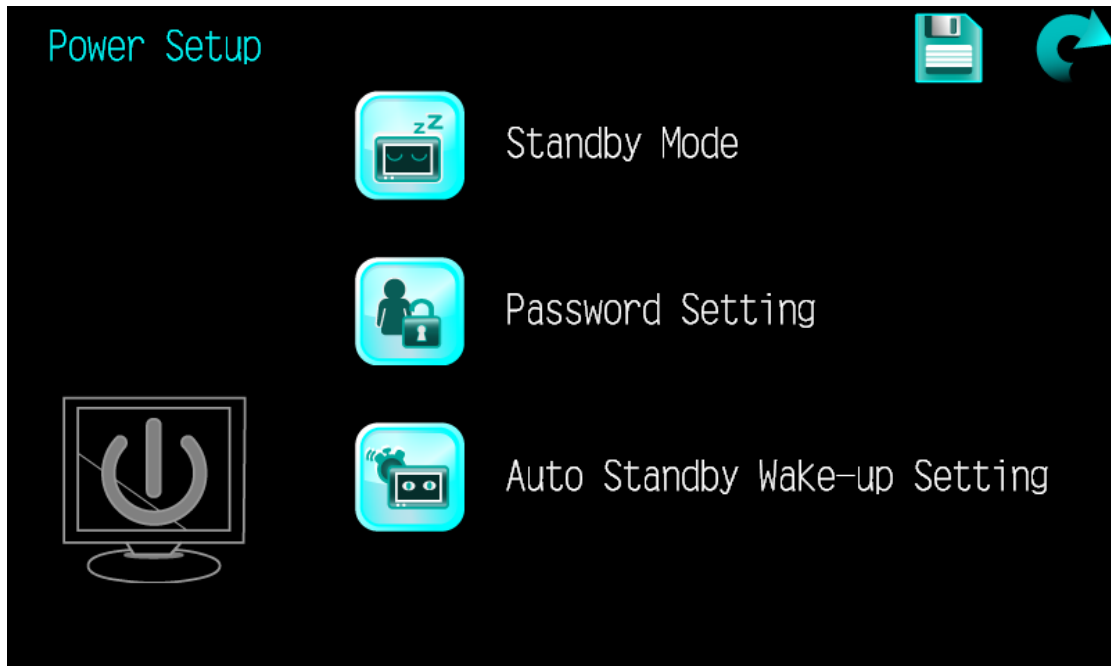
Table 3-3-1 Power Setup Items



	Description	Remark
Standby Mode	Go to Sleep mode after the standby time has elapsed (min)	0~999
Password Setting	Set user password	It needs to match up with the password set in the project. Password setting steps : set the password → click the  icon.
Auto Standby Wake-up Setting	Set system start time	N/A

### 3.4. Communication Setup

Click the Communication Setup icon, the following items will be available, as shown in Table 3-4-1.

Table 3-4-1 Communication Setup Items

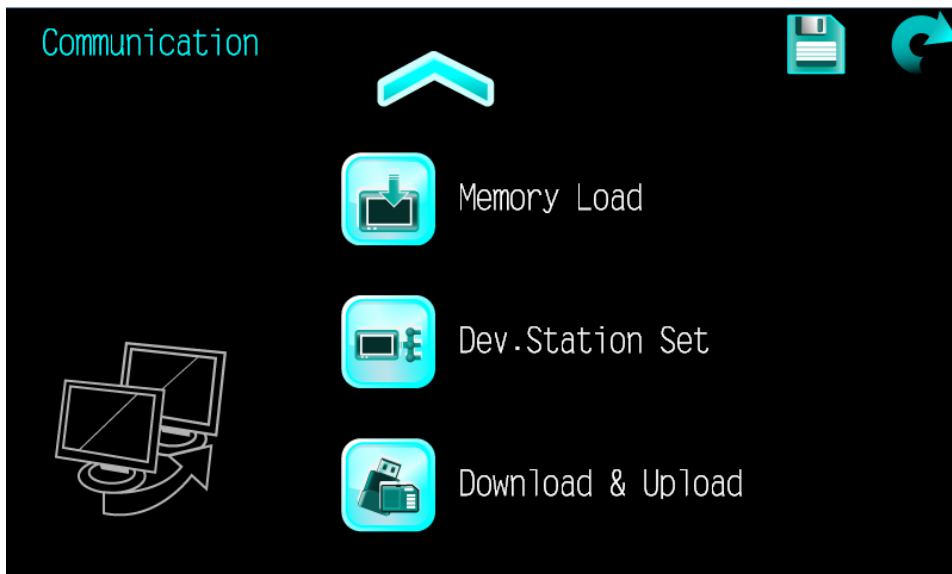
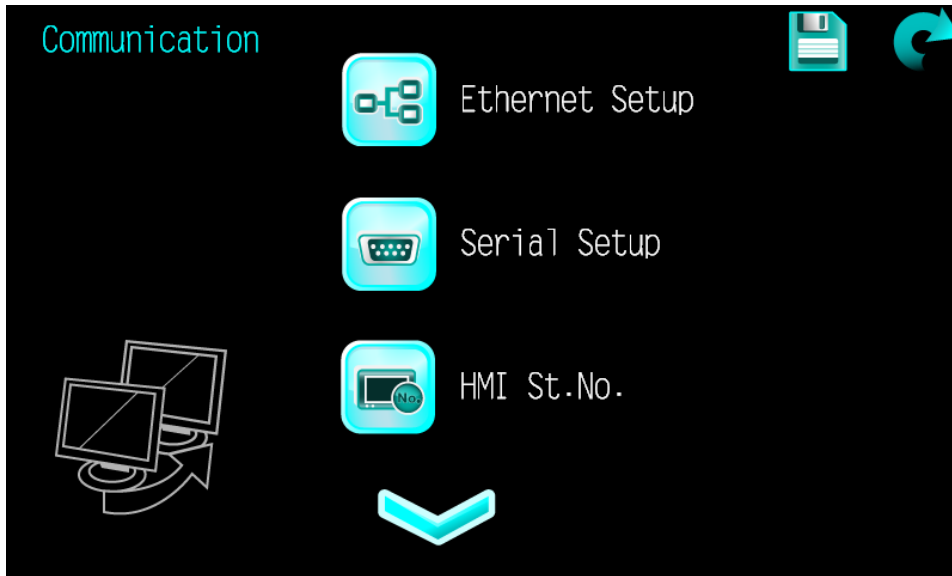

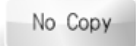
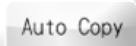







Table 3-4-1 Communication Setup Items (continued)

	Description	Remark
Ethernet Setup	Change the IP address, Netmask, and the gateway.	IP address : 192.168.1.45 Netmask : 255.255.255.0 Gateway : 192.168.1.0
Serial Setup	Change the parameters of the COM1/COM2/COM3 serial ports.	N/A
HMI St. No.	Set the HMI station number.	0~8
Memory Load	Switch to memory/SD card/USB and download the data.	 : Only read the project from the external memory.  : Read and download the project from the external memory.  <u>Steps of NO Copy &amp; Auto Copy:</u> choose the external memory→click the No copy /Auto copy button→click the  icon→click the delete button (the  button under the directory of <u>download &amp; upload</u> ).
	Change SD card/portable disk auto mount	Can select SD card auto mount and portable disk auto mount. After inserting an external storage device into HMI, HMI will automatically load the external storage device.
Dev. Station Set	Control the device switch of specific station number	 : Set up the device station number.
Download & Upload	Set up the source device for data download, upload and OS update.	mount : Read from USB or SD card library/CSV data. USB→HMI/SD→HMI : Sent the file in USB or SD card to HMI. <u>Download steps:</u> " USB→HMI" button or" HMI→USB" button→reload(load new project to HMI). HMI→USB/ HMI→SD : Sent the project in HMI to USB or SD card. <u>Upload steps:</u> " HMI→USB" button or" HMI→USB" button. O.S. upgrade : Read data from USB or SD card to update the OS. <b>NOTE :</b> To delete external memory, be sure to first click the  icon to remove the device



- After the setup is done, be sure to click the  icon to save the settings in the system.
- The network settings are user-definable.
- To delete external memory, be sure to first click the  icon to remove the device. Doing so can ensure subsequent data transfers between external memory and HMI.
- Before using Ethernet to transfer data, set up the TCP/IP address first, as shown in the following Figure 3-4-2.

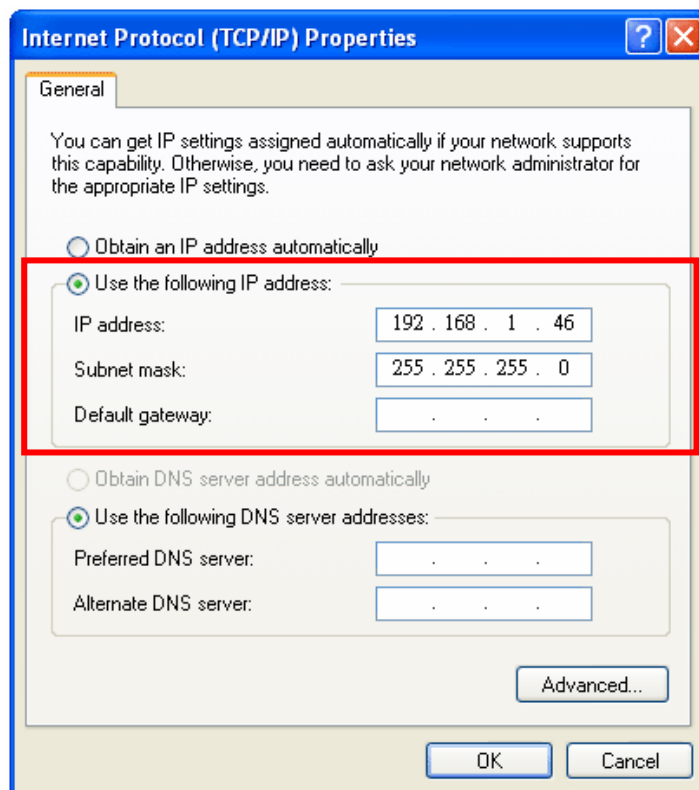



Fig. 3-4-2 IP Address Setup

### 3.5. Language

Click the  icon, users can change the display language. The system provides four languages including Traditional Chinese, Simplified Chinese, English and Japanese, allowing users to switch, as shown in Figure 3-5-1.

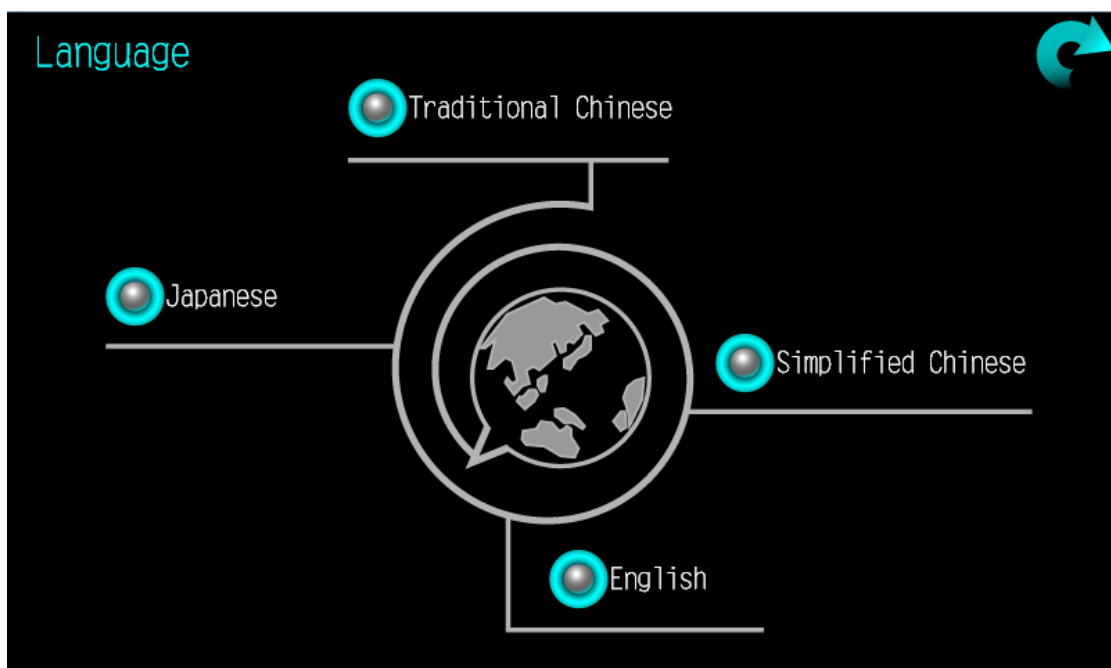
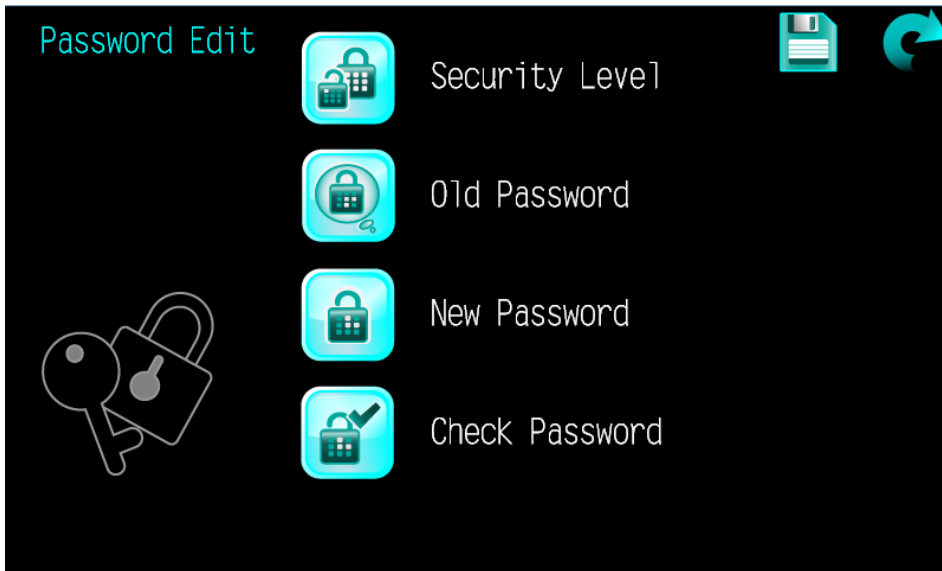



Fig. 3-5-1 Language Setup

### 3.6. Password Edit

Click the Password Editing icon, the following items will be available, as shown in Table 3-6-1.

Table 3-6-1 Password Editing Items



	Description	Remark
Security Level	Set up the password level	0~15
Old Password	Set up the old password	For the first setup, no old password is required. Enter up to 8 digits for the password.
New Password	Set up the new password	
Check Password	Reconfirm the password	

#### NOTE

- After the setup is done, be sure to click the  button to save the settings in the system.
- When the password is set to the highest level of 15, on the upper left corner of the execution screen, touch 5 times consecutively to get back to the system screen (if the time interval between two touches is more than five seconds, HMI will void the count), and then enter the highest-level password.



### 3.7. Interface Test

Click the Interface Test icon, the following test items will be available, as shown in Table 3-7-1.

Table 3-7-1 Interface Test

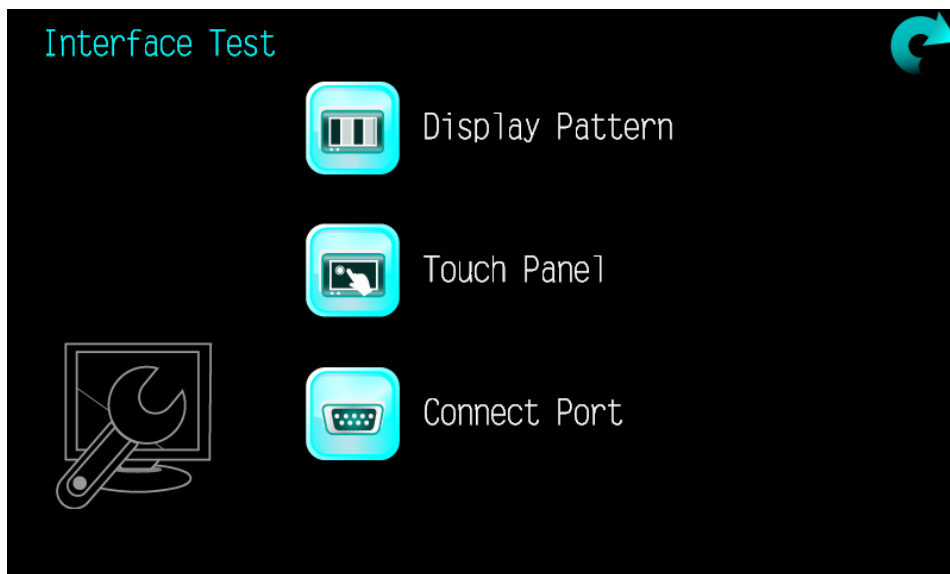

	Description	Remark
Display Pattern	Test screen color	N/A
Touch Panel	Test screen touch points	
Connect Port	Test serial ports	Please short-circuit the cable.

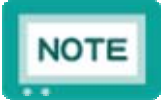

- To test the serial port communication, please short-circuit the pin connection first, as shown in Figure 3-7-2.

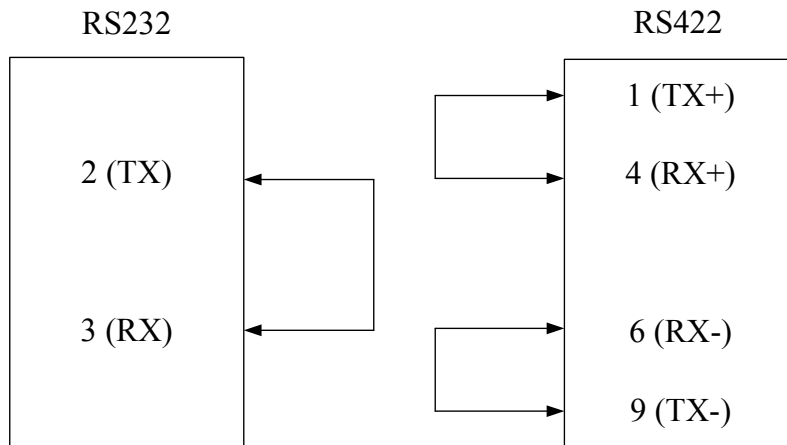



(b)

Fig. 3-7-2 、 Short-circuit Wiring Diagram (a) RS232 (b) RS422

- When the interface is set to RS485, port test can not be self-testing.
- When the setup is done, be sure to click the  button to save the settings in the system.

### 3.8. Data Transfer

When the By Pass function is used, HMI serves as a bridge between PC and PLC, as shown in figure 3-8-1. HMI COM3 is connected to PC, and PLC is connected to COM1/ COM2. If PLC is connected to COM1, click the  button. If PLC is connected to COM2, click the  button. If the screen shown “connected” , it indicates the By Pass function is activated, as shown in figure 3-8-2.

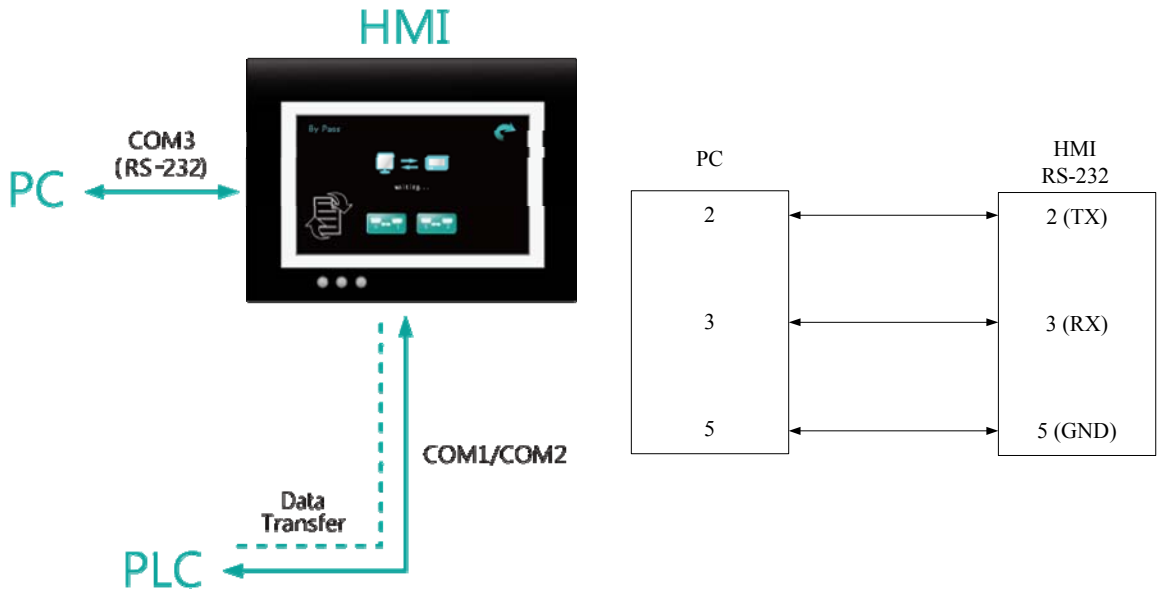

Figure 3-8-1: By Pass connection

COM3(RS-232) Wiring Diagram

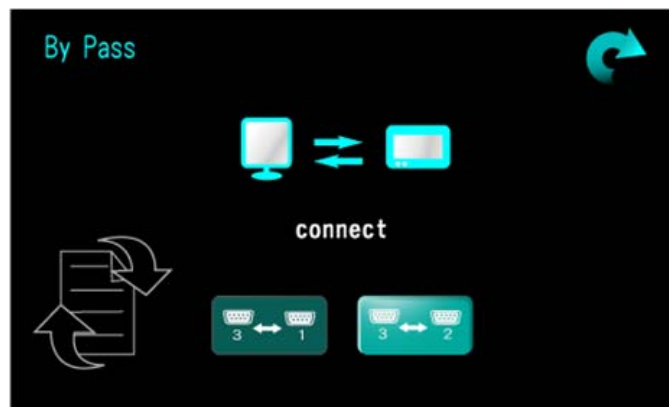
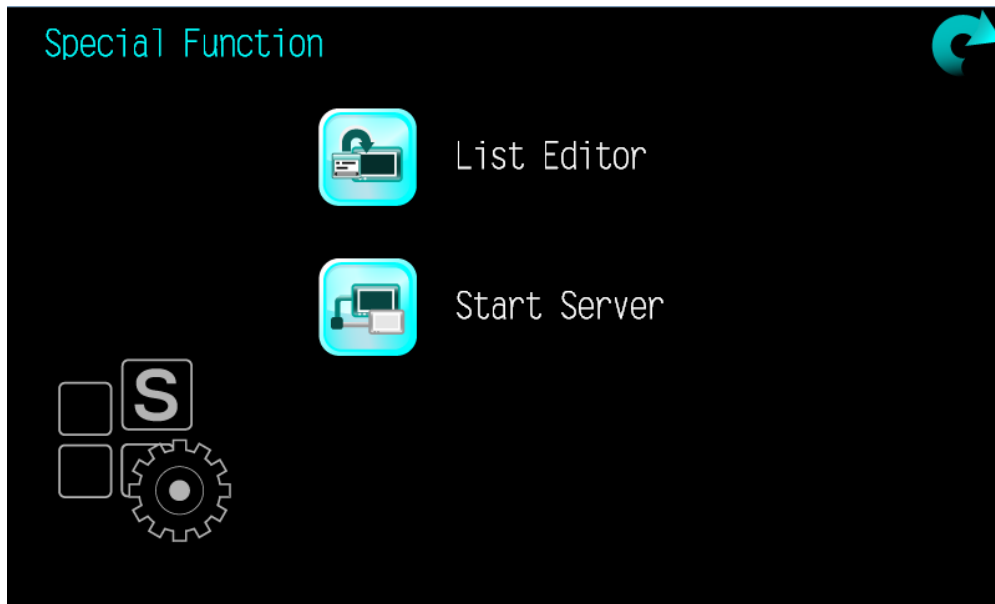



Figure 3-8-2: By Pass is connected

### 3.9. Special Function

Click the Special Functions icon, the following items will be available, as shown in Table 3-9-1.

Table 3-9-1 Special Functions



	Description	Remark
List Editor	Use instructions to modify PLC and monitor the trapezoidal charts	1. Please connect to the PLC device. 2. The instruction list editor supports PLC of Mitsubishi FX series and Shihlin AX series.
Start/Stop Server	Start/close the network monitoring	After connecting network cable, press the “Start/Close server terminal” button, and start the simulation software to start the viewer so as to monitor HMI remotely. For details, see examples as follows.

**NOTE**

- To use instruction list editing and trapezoidal chart monitoring, please connect the PLC device via COM port. The connection is shown in Figure 3-9-2.

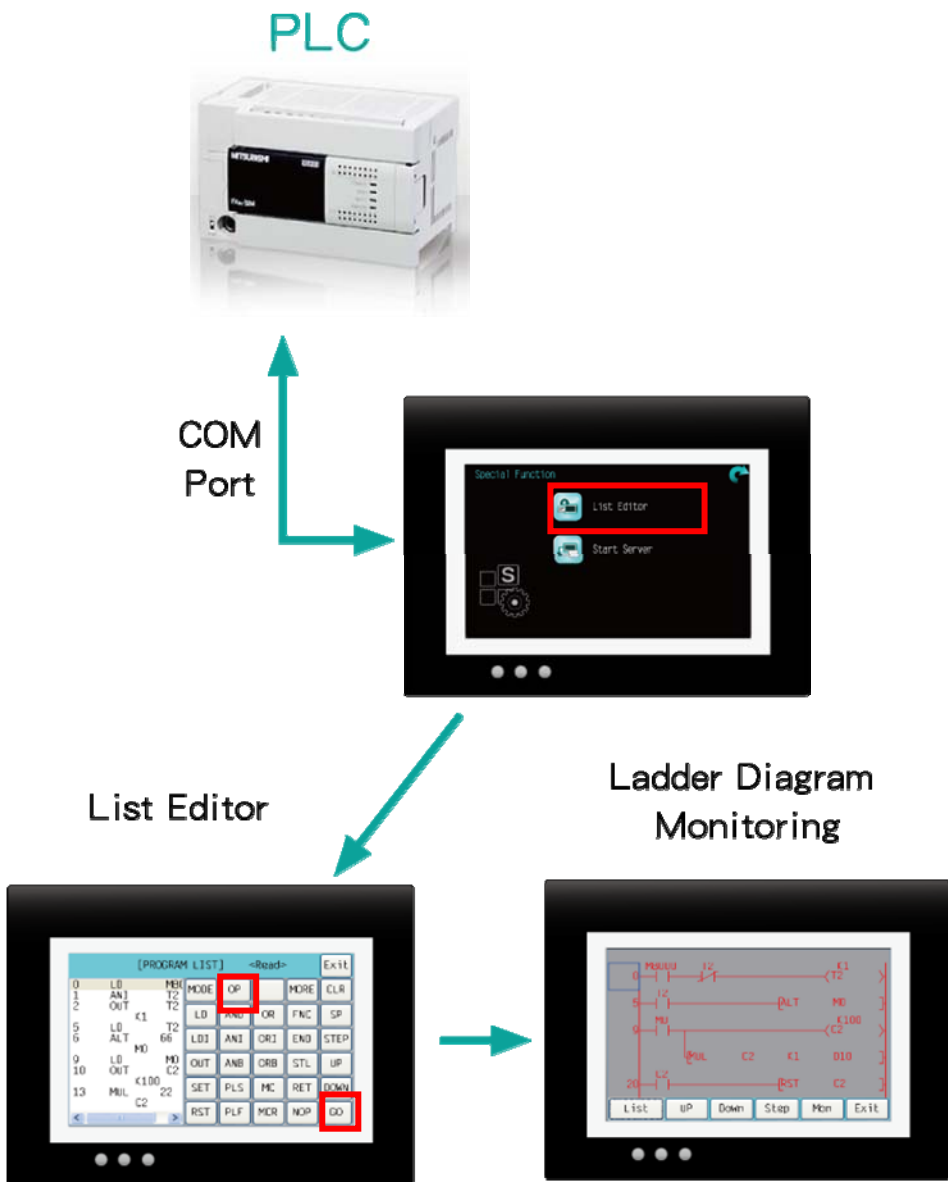



Fig. 3-9-2 PLC Monitoring

### 3.10. Run

To return to the execution screen, please click the  icon to once again get back to the editing screen you were working on.



- If there is no any screen data sent to HMI, you won't be able to use  .

### 3.11. System Information

Click the  icon on the upper right corner of the system screen to view the system information, as shown in Figure 3-11-1.

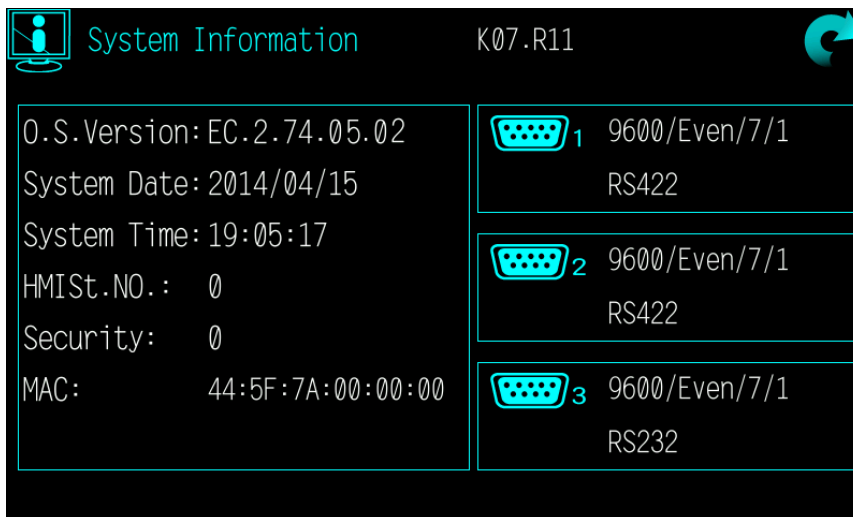



Fig. 3-11-1 System Information

### 3.12. Resume

Click the  icon on the upper right corner of the system screen to view the resume, The high limit of the resume is 255, as shown in Figure 3-12-1.

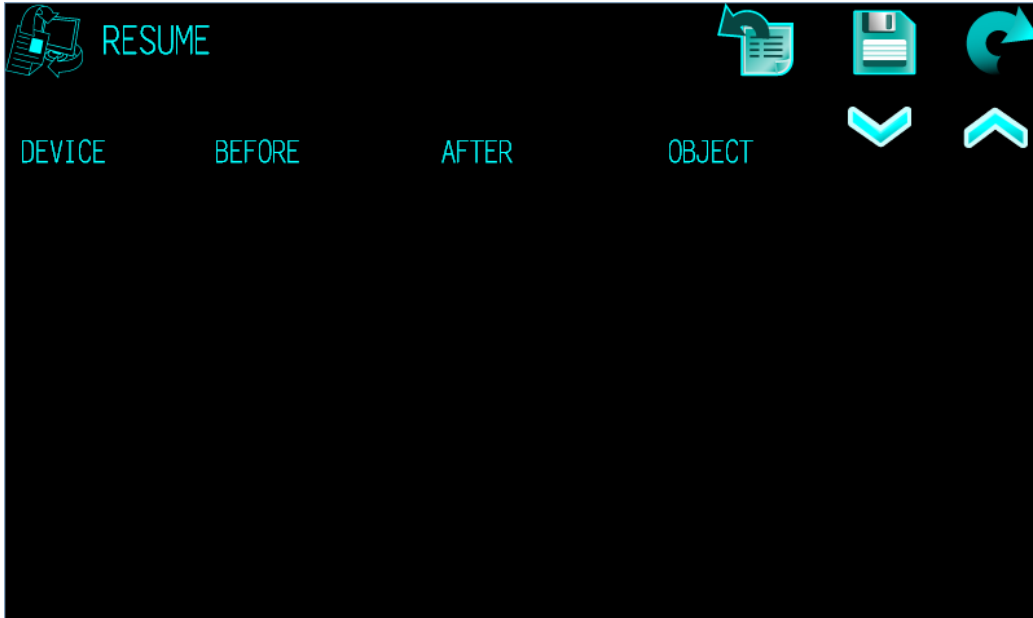





Fig. 3-12-1 Resume

	Description	Remark
Export resume	Step1: click the  button to save resume in HMI internal memory. Step2: click the  button to prepare for exporting resume. Step3: open EU Editor2 to export resume to PC. For the record file transfer, see <a href="#">section 3.8.3 “Transfer tool”</a> stated in <a href="#">EUEditor manual-EC200</a> .	File extension is .csv.



## Appendix A: Additional description

### A.1.Remote monitoring

#### A.1.1.Local network connection

The remote monitoring of local network is operated as follows.

Requirements:

1. The remote monitoring needs a jumper as the private network cable (network jumper is described in section 2.3).
2. HMI must be equipped with network port (two code behind the model is 11 means it is the network type).

Local network IP address (Internal local network of Shihlin Electric) is set as follows:

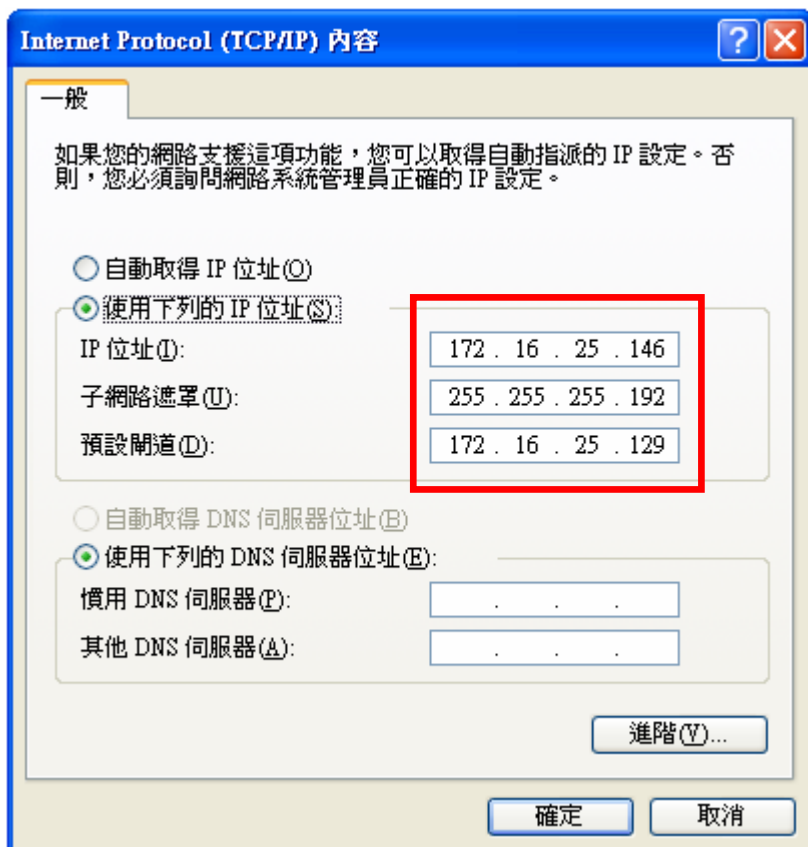



Step 1:

Select Communication Setting → Ethernet Setting under OS menu, and after setting “IP address” ,” Netmask” and “Gate” , click the  button to save settings.

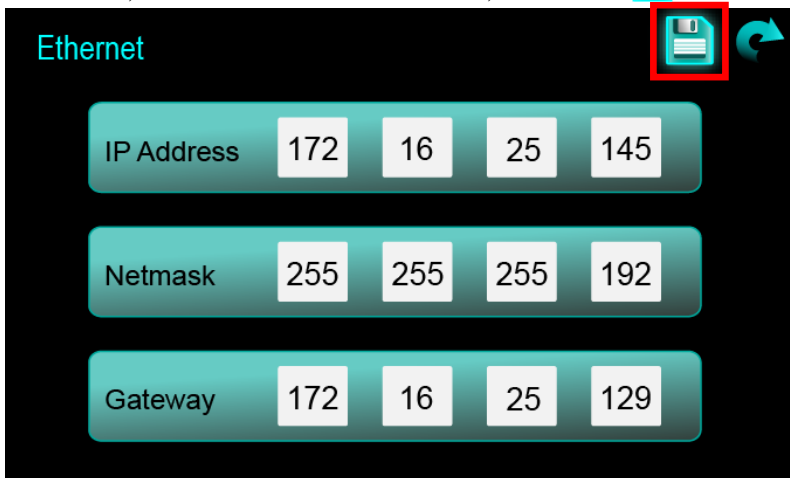

Step 2:

Return to the OS menu, and select the special function button.

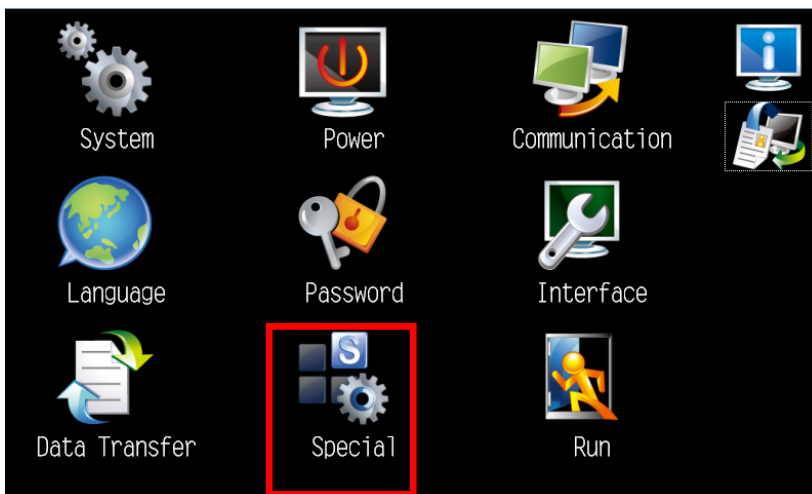

After entering, select the Start Server (After clicking the Start Server, it will show as follows).

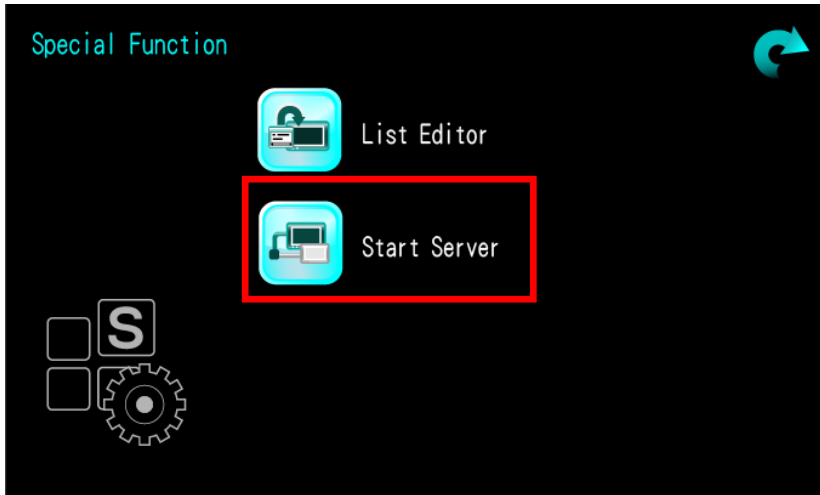

The figure after clicking the Start Server is as below. Connection is completed after finishing the above setup.

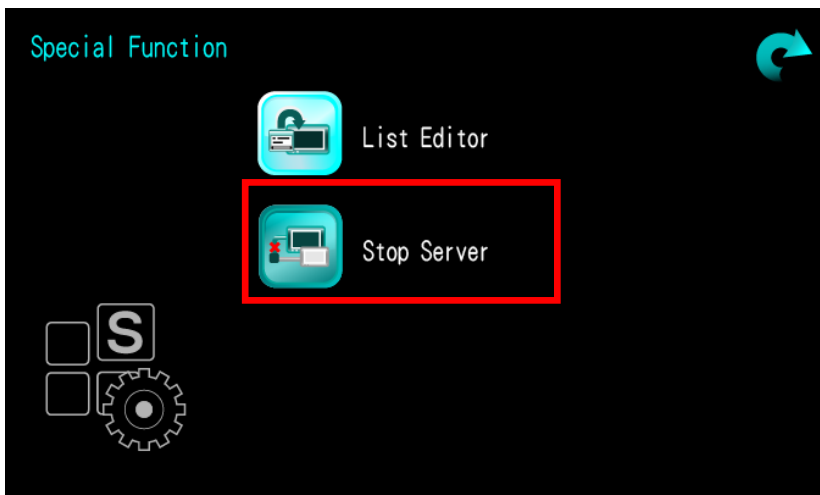

Simulation software setting:

Step 1:

Start the simulation software and select corresponding HMI type.

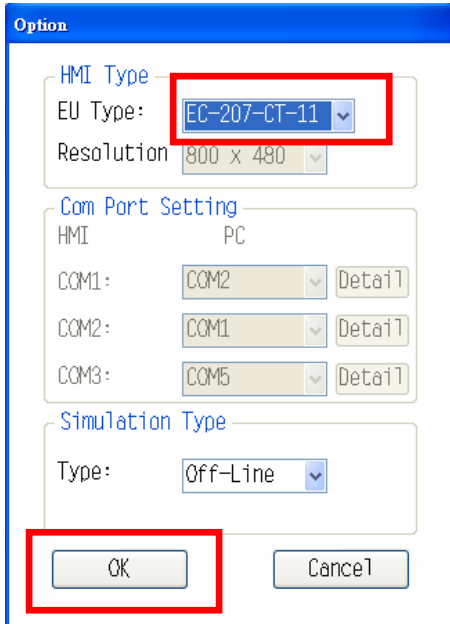

Step 2:

Move the mouse to the upper right and press the right mouse button to bring up the context menu. Press the "Start Viewer" button to start the connection function (press the same button to stop the viewer).

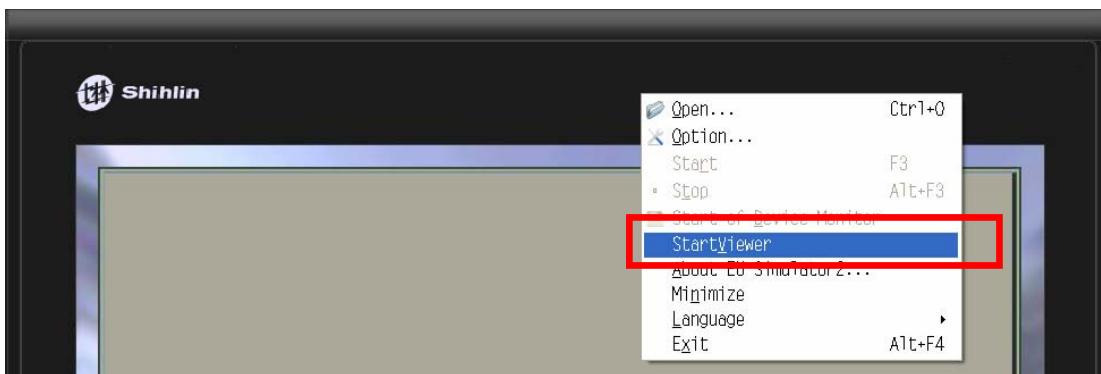

Step 3:

After opening the connection setting window, click the New button and enter HMI IP address.

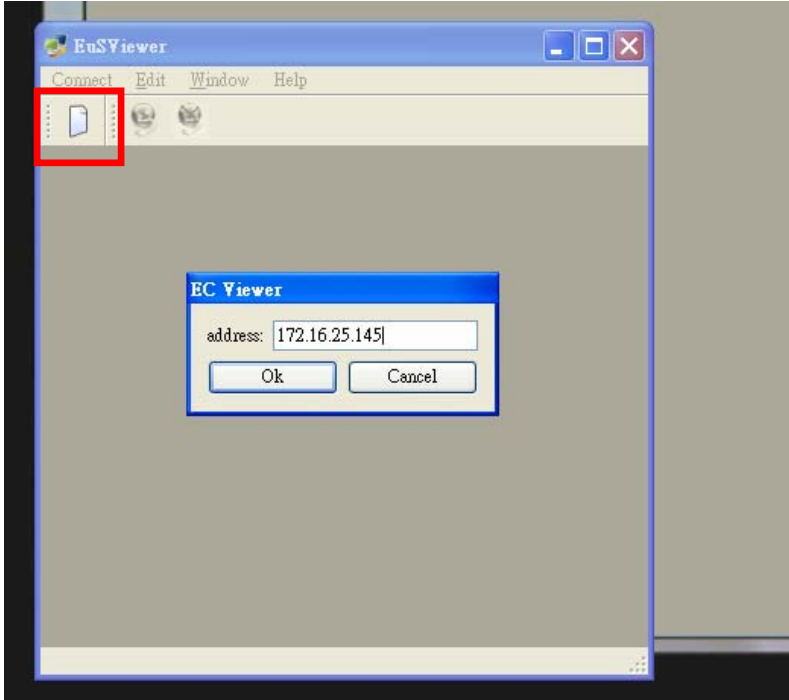

Start the viewer

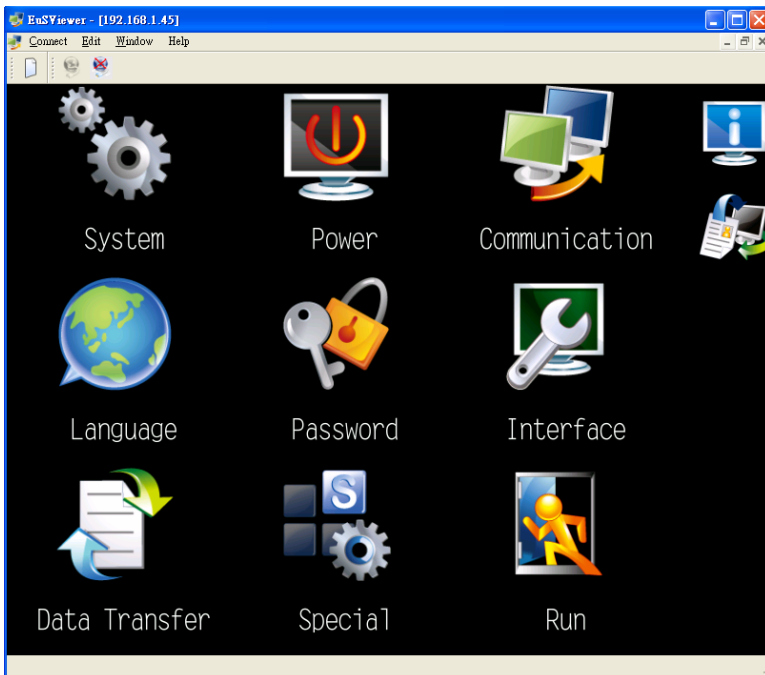

### A.1.2. Internet connection

Requirements:

1. The remote monitoring needs a jumper as the private network cable (network jumper is described in section 2.3).
2. HMI must be equipped with network port (two code behind the model is 11 means it is the network type).
3. HMI and PC must have a set of “fixed IP address” , and apply for “51008” and “51009” network port to start.
4. Firmware must be K04.R0710401 or later version

The remote monitoring of internet is operated as follows:

Step 1:

Select Communication Setting → En Setting under OS system, and after setting “fixed IP address” , press button to save  settings.

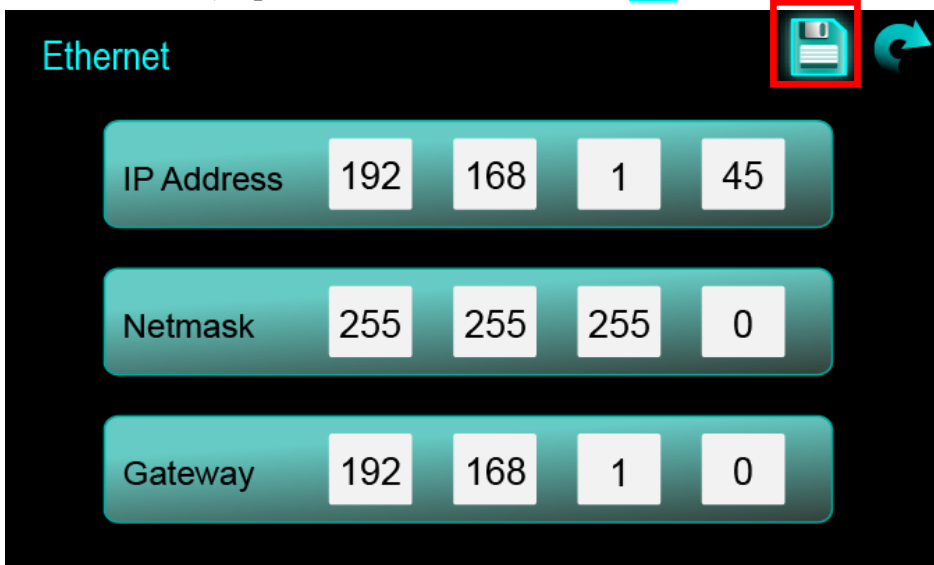

Step 2:

Return to OS system screen, and select the special function button.

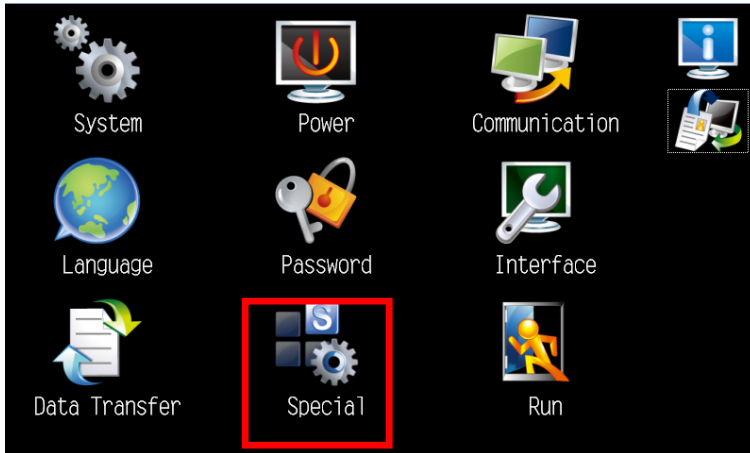

After entering, select the Start Server.

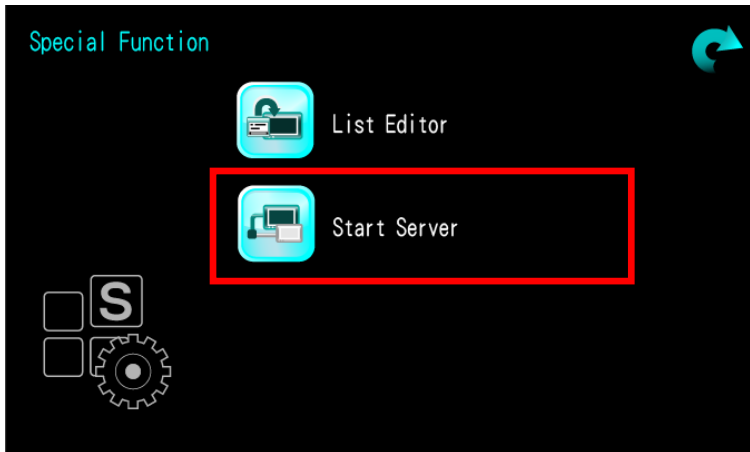

The figure after clicking the Start Server is as below. Connection is completed after finishing the above setup.



Simulation software setting:

Step 1:

Start the simulation software and select corresponding HMI type.

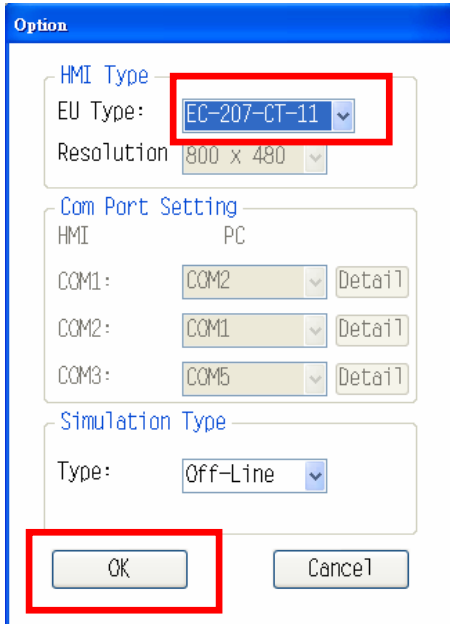

Step 2:

Move the mouse to the upper right and press the right mouse button to bring up the context menu. Press the "Start Viewer" button to start the connection function (press the same button to stop the viewer).

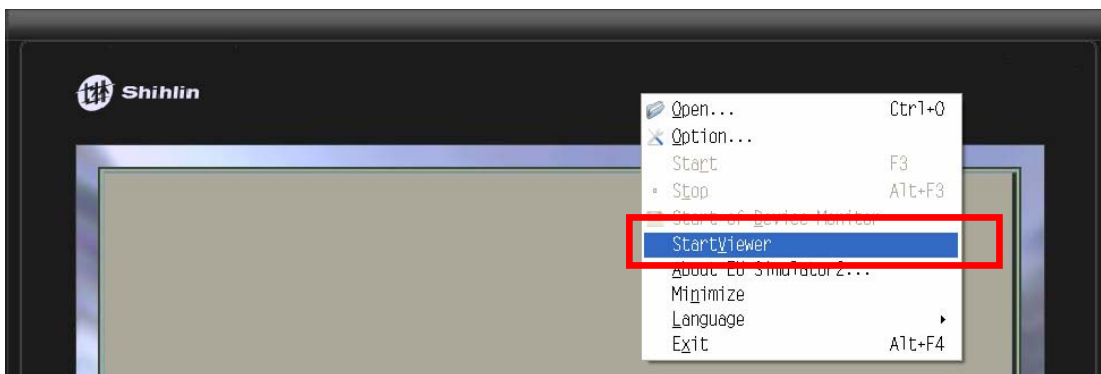

Step 3:

After opening the connection setting window, click the New button and enter HMI  
“fixed IP address” .

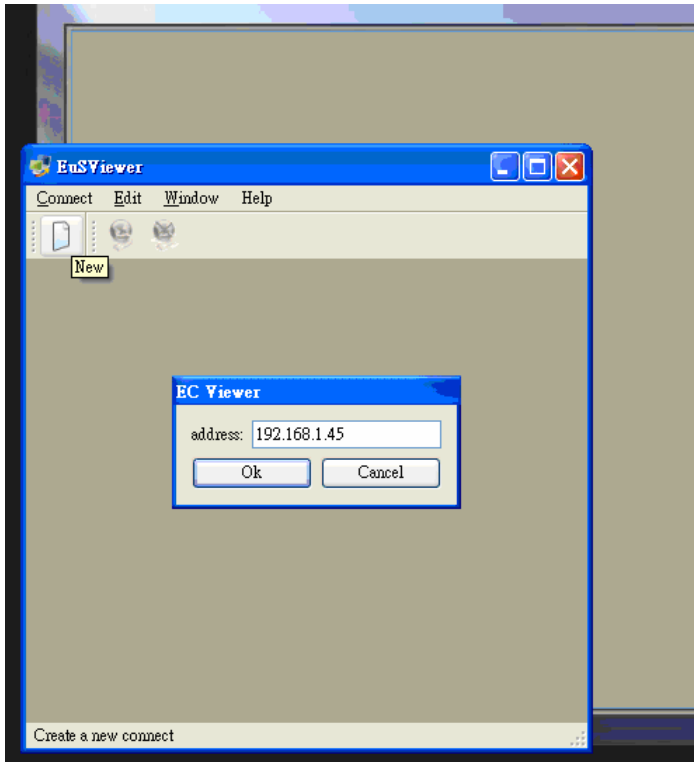

Start the viewer

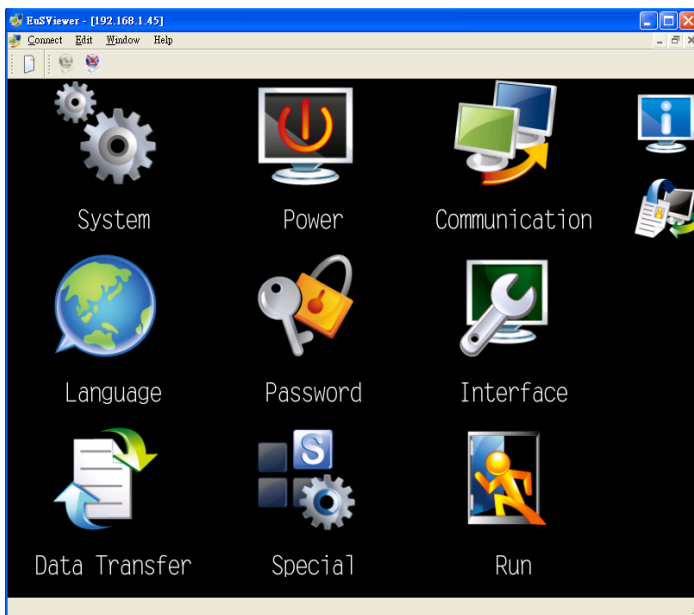



## A.2. FTP server reads record file

When the record file is saved in a SD card/USB disk, FTP will read the record file (eu200\_project folder) from PC. The record file includes recipe data, logging data and alarm data, etc.



The use of FTP to read record file shall contain conditions as below:

1. Special network cable for jumper. (See section 2.3 to know how to jump network cable)
2. Selection of HMI type shall have the network Port. (if the last two codes is 11 of model name, the model is the network type)
3. OS 05.02 or later. (including OS 05.02)
4. FTP reads the record file and opens the device:  
HB65008 (ON): read record file from USB disk.  
HB65009 (ON): read record file from SD disk.

It shall be set as below (Example: Shihlin HMI default network setup):

HMI setup:

Under OS, select COM setup→Network Setup, and after setting the 『IP address』, 『subnet mask』 and 『Channel』, press the  button to save settings.

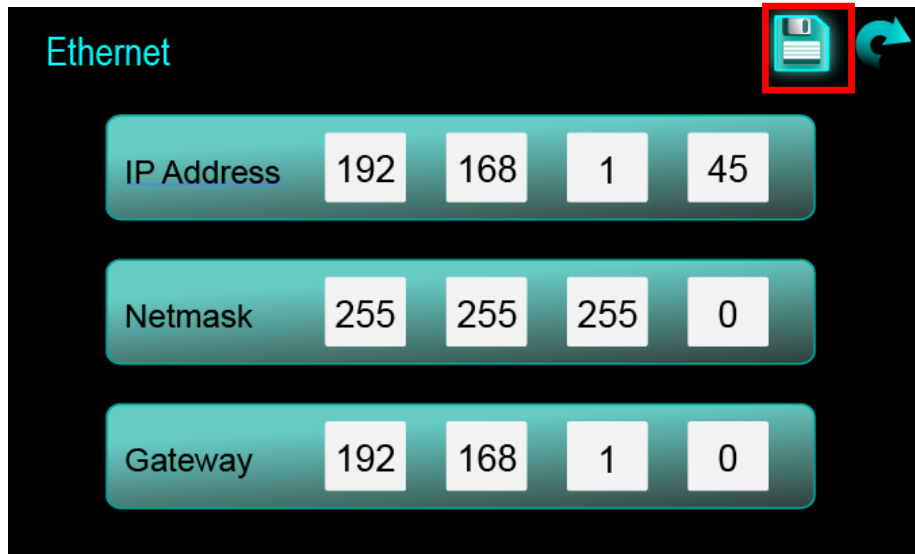

PC setup:

In the URL of the PC, enter the IP address of HMI: <ftp://192.168.1.45>, then it can read the record file.

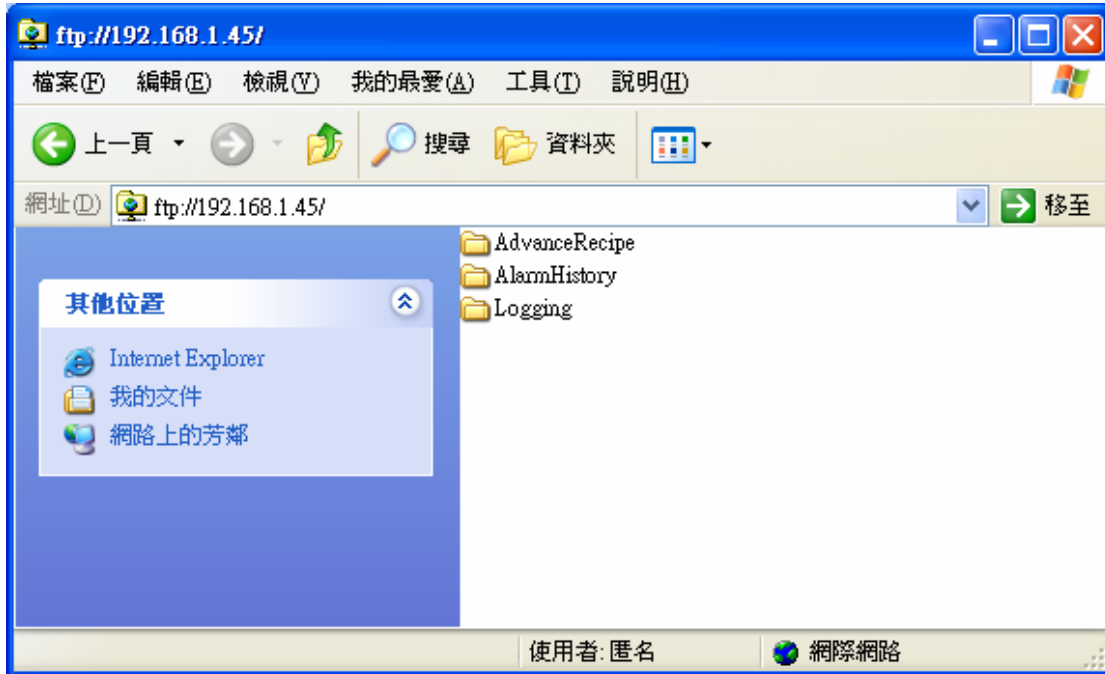

### A.3. Communication error warning message

If the communication cable is wrongly connected, communication parameters are wrong set or PLC station number is wrong set, HMI will pop up a warning window.

As shown in the following figure, there is a problem with the station 0 of com 2.

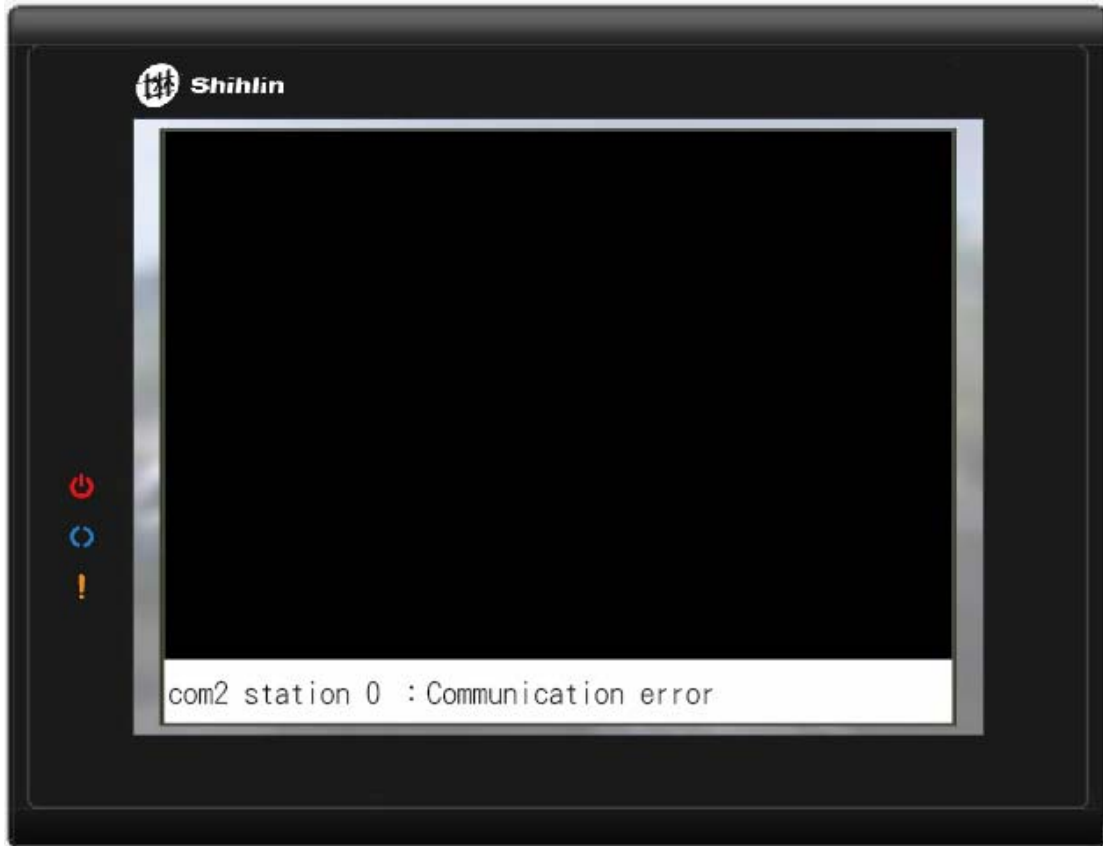

Communication error warning message

## A.4. How to cope with the noise interference

### WIRING PRECAUTIONS :



#### DANGER

---

- Be sure to shut off all phases of the external power supply used by the system before wiring.
- Failure to do so may result in an electric shock, product damage or malfunctions.
- Please make sure to ground FG terminal of the HMI power supply section by applying 100Ω or less which is used exclusively for the HMI.
- Not doing so may cause an electric shock or malfunction.
- Correctly wire the HMI power supply section after confirming the rated voltage and terminal arrangement of the product.
- Not doing so can cause a fire or failure.
- Tighten the terminal screws of the HMI power supply section in the specified torque range.
- Undertightening can cause a short circuit or malfunction.
- Overtightening can cause a short circuit or malfunction due to the damage of the screws or the HMI.
- Exercise care to avoid foreign matter such as chips and wire offcuts entering the HMI.
- Not doing so can cause a fire, failure or malfunction.



#### CAUTION

---

- Please use the isolated power supply.
- Plug the communication cable into the connector of the connected unit and tighten the mounting and terminal screws in the specified torque range.  
Undertightening can cause a short circuit or malfunction.  
Overtightening can cause a short circuit or malfunction due to the damage of the screws or unit.

There are two kinds of noises: Radiated noise that is transmitted into the air and Conductive noise that is directly transmitted along connected lines.

Countermeasures must be taken considering both kinds of noises and referring to the following 3 points :

- (1) Releasing noise to the ground
  - (a) Make sure to connect the ground cable to the ground.
  - (b) Use a short and thick cable to lower its ground resistance.
  - (c) Ground the power system and the control system separately.
- (2) Protecting against noise
  - (a) Keep signal lines away from noise sources such as a power cable or a high-power drive circuit.
  - (b) Shield the signal lines.
- (3) Reducing generated noise
  - (a) Use a noise filter, etc. to reduce the level of the noise generated due to a source such as a high-power motor drive circuit.
  - (b) Attach surge killers to the terminals on the no fuse breakers (NFB), electromagnetic contactors, relays, solenoid valves, and generators to suppress noise interference.

For details, please refer to the following sections.

#### A.4.1. Grounding the HMI and other devices

Make sure to carry out the followings for grounding.

Except 5V power supply type.

- Carry out the independent grounding if possible.
- Provide class D (class 3) grounding. (Ground resistance must be  $100\Omega$  or less.)
- If the independent grounding is impossible, carry out the shared grounding as shown in fig.2) below.

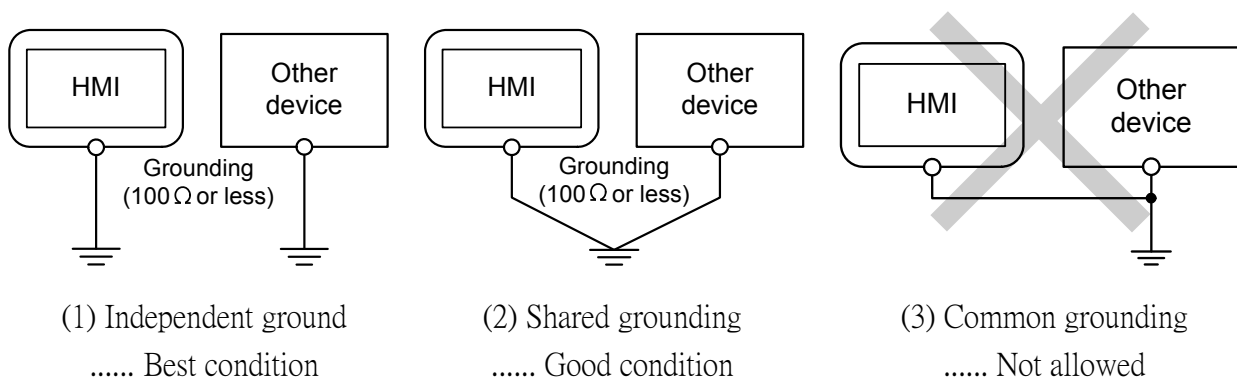

## A.4.2. The cause of malfunctions related wiring/Remedy

Grounding of the HMI may cause electric potential difference and noise interference, which may result in HMI malfunctions.

These problems may be resolved by taking the following measures.

### A.4.2.1. Wiring path of the HMI's ground cable and power line

- Bundling the HMI's ground cable and power line together can cause interference noise, which may result in malfunctions(fig.1).
- Keeping the HMI's ground cable and power line away from each other will help minimize noise interference(fig.2).

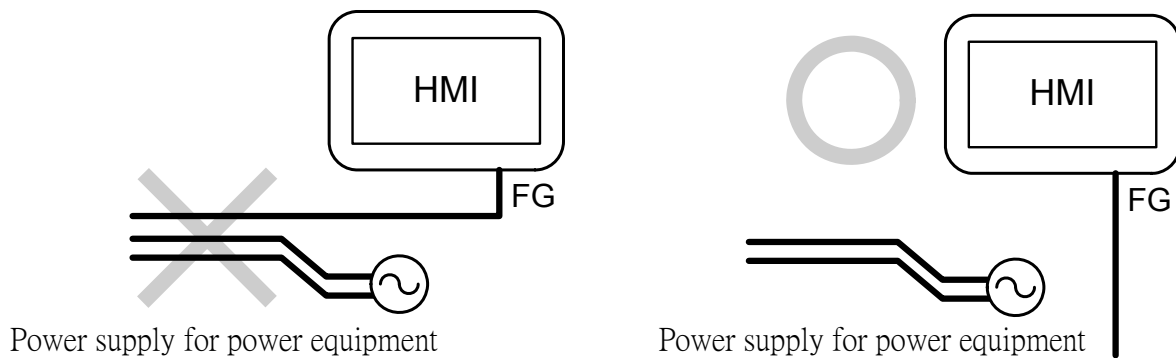

(1) Bundling the ground cable and the power cable

(2) Wiring the ground cable away from the power cable

### A.4.2.2. Connecting the ground cable from the panel that houses control equipment to the panel to which the HMI is grounded

When running a single ground cable from the panel that houses such piece of control equipment as a sequencer to the panel to which the HMI is grounded, the ground cable may have to be directly connected to the terminal on the HMI.

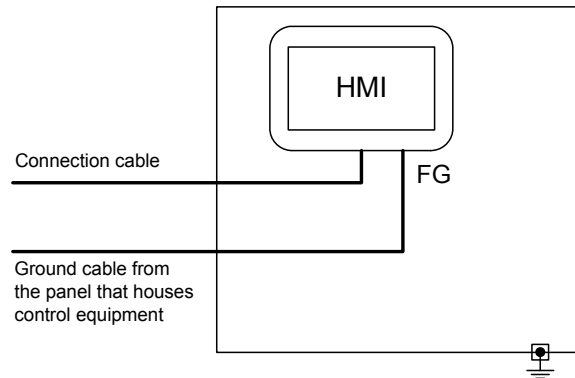

If electric potential difference between the ground points created by it causes malfunctions, lowering the voltage as shown in Remedy 1 below may solve the problem.

## Remedy 1

- If the electric potential difference between the ground cable and the panel that houses the HMI is creating problems, connect the ground cable to the panel also.
- If the wiring method as shown in Remedy 1-1 is not feasible, follow Remedy 1-2.

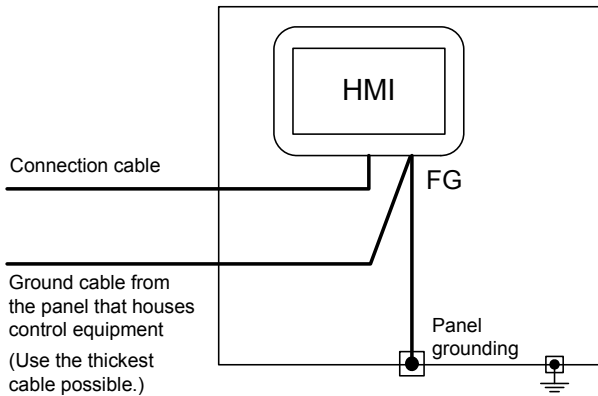

Remedy1-1

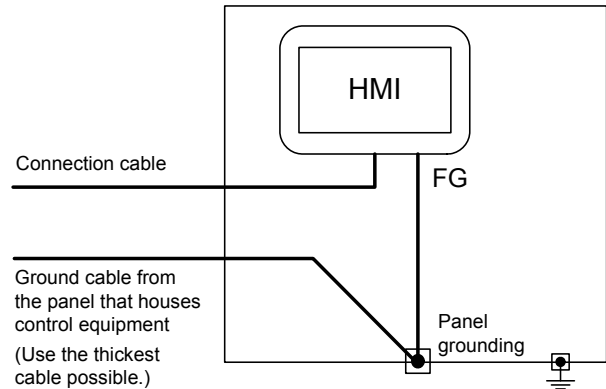

Remedy1-2

If taking Remedy 1 worsens noise interference, taking Remedy 2 may alleviate it.

## Remedy 2

- Attach a ferrite core to the cable if noise from the HMI panel has adverse effects on the HMI when Remedy 1 is taken.
- Wind the wire around the ferrite core several times (approx. 3 times), if a ferrite core is used.
- If the wiring method as shown in Remedy 2-1 is not feasible, follow Remedy 2-2.

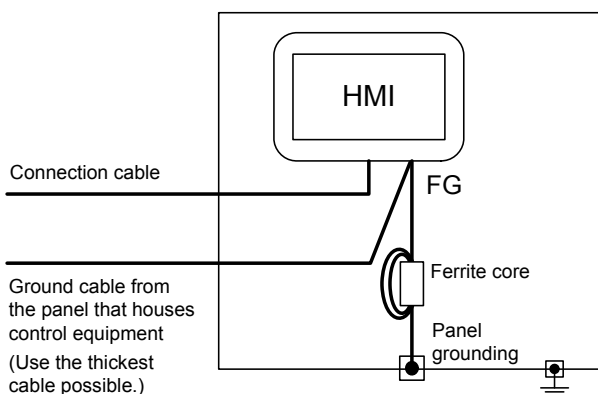

Remedy2-1

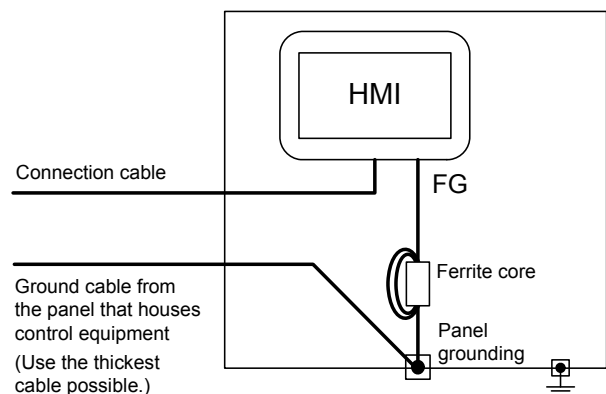

Remedy2-2

### A.4.3. Wiring inside and outside the panel

#### A.4.3.1. Wiring inside

- Run power lines, servo amplifier drive wires, and communication cables so that they do not cross each other.
- Noise interference that is generated by cables that cross each other may cause malfunctions.
- Surge suppressors are an effective way to filter out surge noise that is generated from no fuse breakers (NFB), electromagnetic contactors (MC), relays (RA), solenoid valves, and induction motors.

(Refer to the section to follow for surge killers : [A.4.3.3.Attaching surge killers to control equipment](#) )

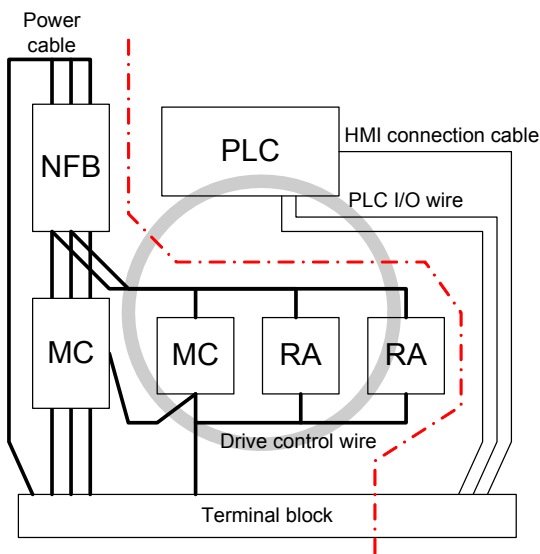

Uncrossed power lines and communication cables

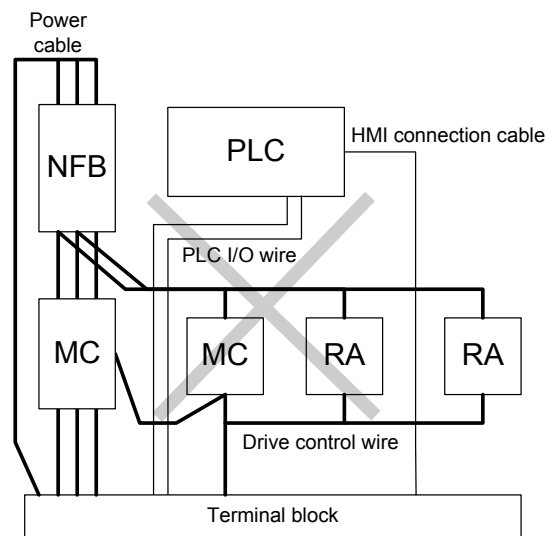

Crossing power lines and communication

#### A.4.3.2. Outside the panel

To pull the power line and communication cable out of the panel, make two pullout holes away from each other and pull the cables through.

Putting both cables through the same pullout hole will increase noise interference.

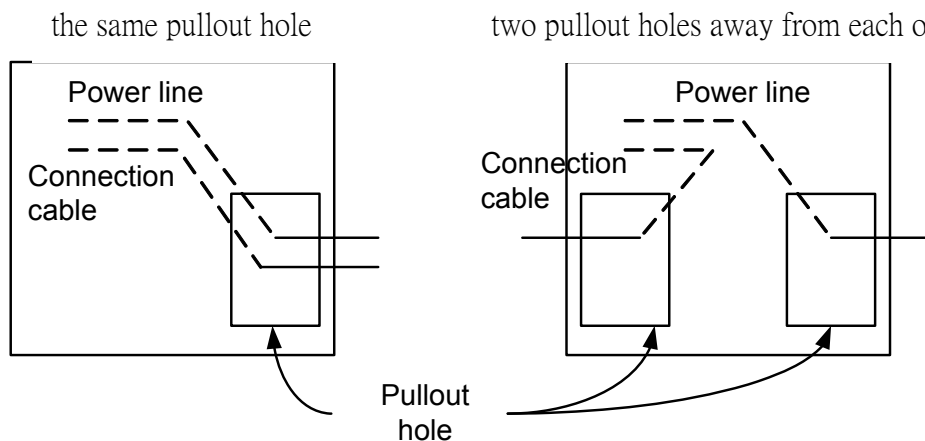



Keep the power line and communication cable inside the duct at least 100 mm away from each other. If that is not possible, the use of a metal separator inside the duct can reduce noise interference.

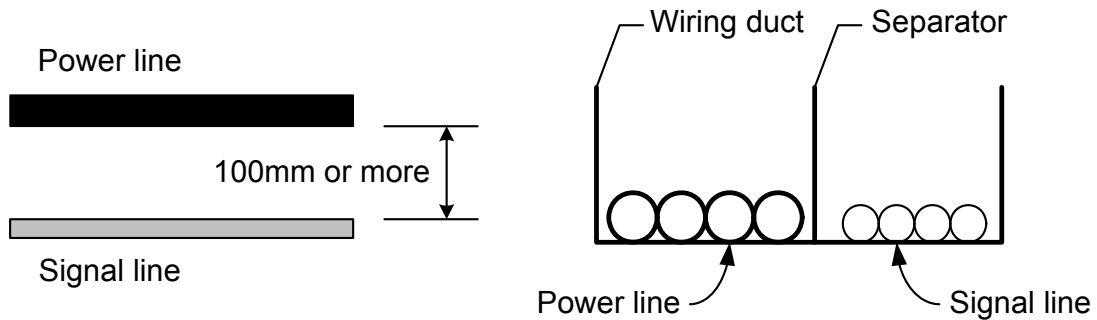

#### A.4.3.3. Attaching surge killers to control equipment

If communication errors happen in synch with the on/off signals from certain control equipment (referred to as "load" hereafter) such as no fuse breakers, electromagnetic contactors, relays, solenoid valves, and induction motors, surge noise interference is suspected.

- If this problem happens, keep the ground cable and communication cable away from the load.
- If that is not possible, an installation of a surge killer will help reduce noise interference.
- Place the surge killer as close to the load as possible.

Remedy for AC inductive load

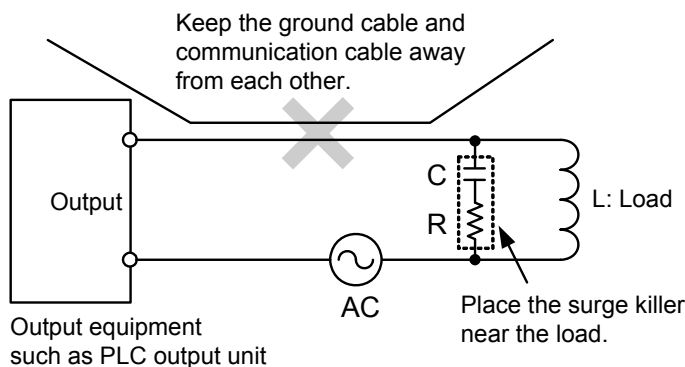

Remedy for DC inductive load

