

IN PURSUIT OF GROWTH & EXCELLENCE



SDE Series



NEW SDE Series

The Choice of Cost-effective
Smaller and lighter
with evolutonal performance



Contents

Features	2
Model Definition	5
Product Corresponding Table	6
Servo Drive Specifications	7
Connections with Peripheral Equipment	8
Servo Drive Dimensions	9
Servo Motor Specifications	10
Servo Motor Torque Characteristic	13
Servo Motor Dimensions	15
Wiring Diagram	17
Optional Accessories	21

Features

Real Time Auto Tuning, User Friendly

Quick and accurate automatic load inertia ratio estimating function

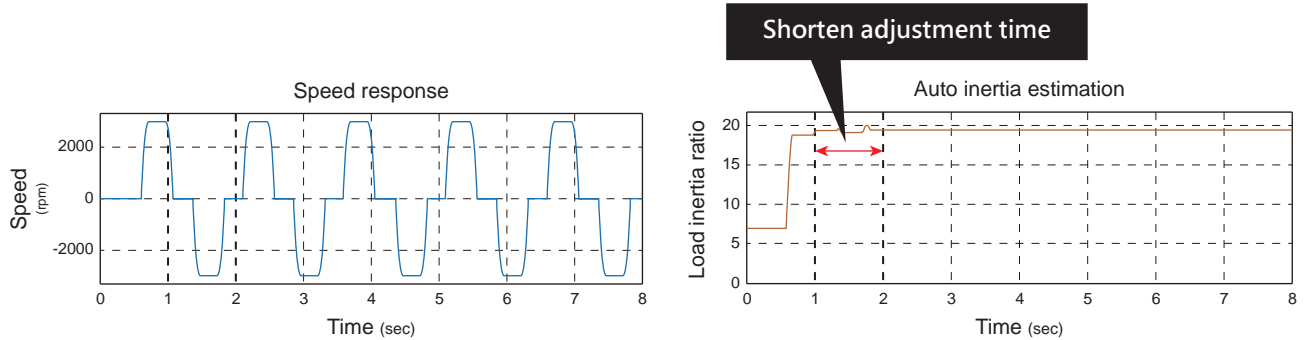

Real time auto tuning can estimate the load inertia ratio fast and accurately. The error of estimated load inertia for both ball screw and belt system is less than 10%, also auto tuning could estimate the load inertia ratio within one cycle (forward + reverse).

Outstanding Speed Response Performance, 3 times faster

Speed frequency response
1.2k Hz
 ↑
 400 Hz

The servo speed frequency response is 1.2k Hz, which is faster than the SDB Series 3 times and help to shorten the setting time reduced to 1ms, with high speed, high response and accurate positioning characteristics.

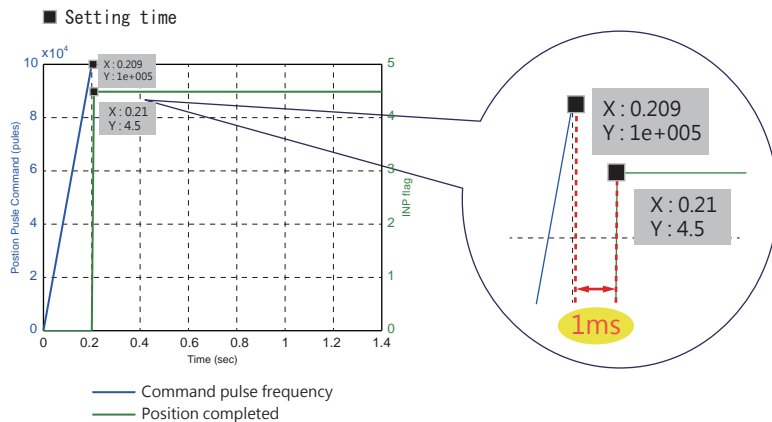

High-resolution



High-resolution Encoder

22 Bit

4,194,304 pulse/rev

Equipped with Japanese high-level absolute position encoder what resolution is up to 4,194,304 pulse / rev could position more accurately and improve the stableness of low-speed. Japanese encoder provides quality assurance.

Features

Reduce Resonance & Vibration

To inertia system of mechanical, both two low-frequency vibration from the end of arm to main body could be suppressed at the same time by vibration control algorithms. Machine performance is utilized to the fullest using the advanced vibration suppression control function.

Automatic high-frequency vibration suppression function could be turned on directly in motion mode and search for the vibration frequency that through machine resonance suppression filter be controlled. Shorten the setting time and improve equipment performance.

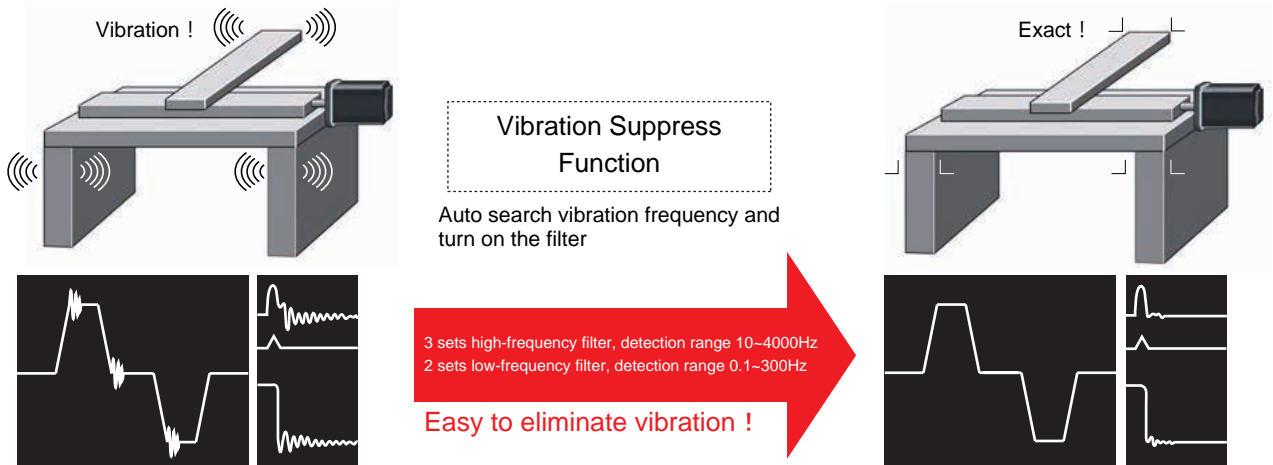

Compact Size

Industry's smallest*



SDE motor requires 40% less installation space than SMA. (In the case of 400W)

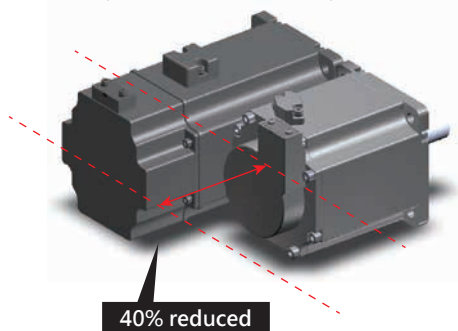

Certification



High Speed

High Speed
6000 rpm
↑
4500 rpm

Speed increasing and better torque output help to enhance productivity.

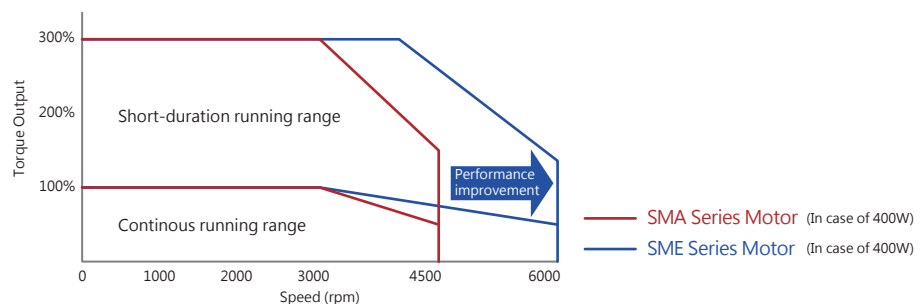

Absolute Position System Optional

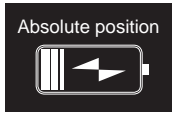

Use optional battery to memory absolute position when power-off.
(Absolute motor and battery is optional)

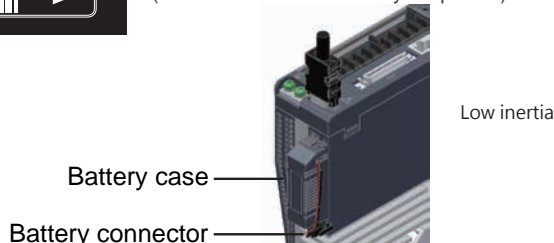

Battery wiring figure

Low Inertia Capacity Expansion

Applicable to high frequency and high torque equipment, such as bag making machine, printing machine, feeding machine ... and so on.

Series	Capacity/Resolution	Capacity Range							
		100W	200W	400W	750W	1KW	1.5KW	2KW	3KW
SME	Low inertia (22 bit)								Low inertia up to 3KW
	Medium inertia (22 bit)								

Built-in Simple PLC Function (Single-axis Control Mode)

With high flexibility and simple position PLC program, help maker to reduce equipment costs.

Multiple control functions



64 Section program



Position edit mode



± limit setup



35 Types home position return mode



Absolute position mode

<Indexer (turret) Function>

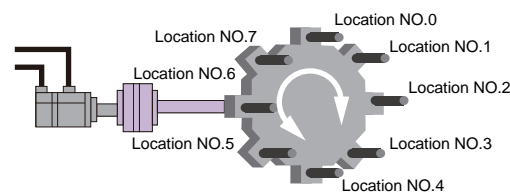

- Provide auto mode, manual onestep, manual continuous and Jog functions.
- Auto search for shortest indexer route.

Stable Speed and Low Torque Ripple

The torque ripple is under 1.5% help to rotate smoothly during a low-speed operation which is more likely affected by the torque ripple, improving the operation stability.

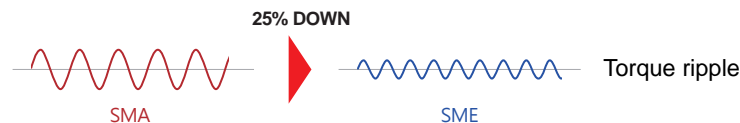

Powerful Software

Fully support from setup to troubleshooting.

- Complete control



Easy Tuning
Auto gain tuning and inertia estimation interface.

- Data tracking

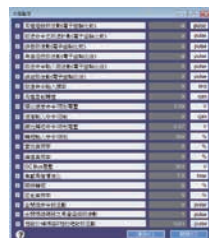

Status Monitoring
Display the servo motor current status on time.(ex.load inertia ratio,etc)

- Multiple function monitoring

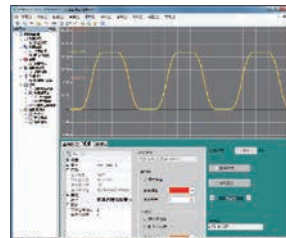

Oscilloscope Function
Oscilloscope long term status capturing function.

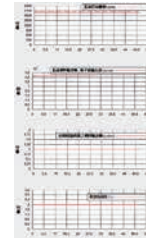

Detail Display
Display various detail reports at the same time and capable of saving those data..

Servo Motors Model Definition

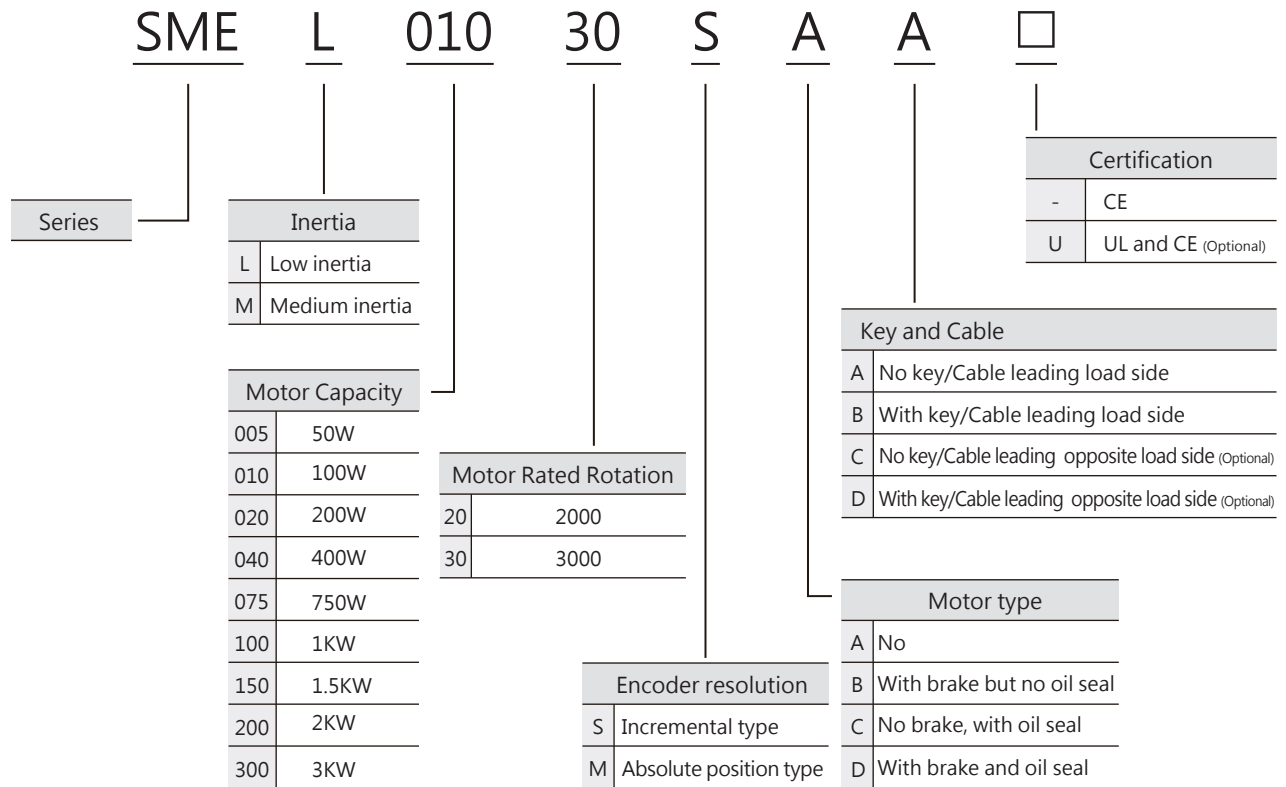

Servo Drives Model Definition

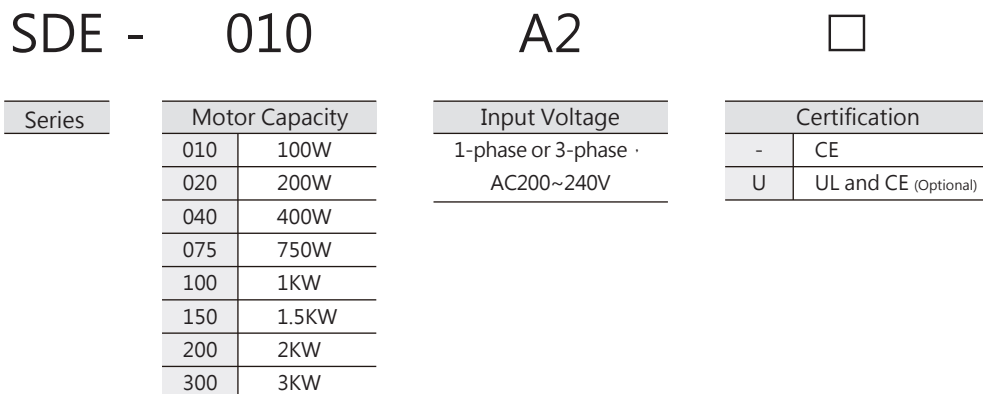

Product Corresponding Table

Combinations of Servo Drive and Servo Motor

Drive	SDE-□□□		010	010	020	040	075	100	150	200	300
Servo Motor	SME-L (Low inertia)	3000rpm	005	010	020	040	075	/	/	/	/
		2000rpm	/	/	/	/	/	100	150	200	300
	SME-M (Medium inertia)	2000rpm	/	/	/	/	/	100	150	200	300

Motor Series	Capacity	Servo Motor	Servo Drive	CN1 Connector	Encoder Cable (length:5m)	Power Connector (U,V,W)
SME-L Series Low inertia Small Capacity 3000RPM	50W	SME-L00530SAA	SDE-010A2	SDA-CN1	SDH-ENL-5M-L-(T)	SDA-PWCNL1
	100W	SME-L01030SAA	SDE-010A2	SDA-CN1	SDH-ENL-5M-L-(T)	SDA-PWCNL1
	200W	SME-L02030SAA	SDE-020A2	SDA-CN1	SDH-ENL-5M-L-(T)	SDA-PWCNL1
	400W	SME-L04030SAA	SDE-040A2	SDA-CN1	SDH-ENL-5M-L-(T)	SDA-PWCNL1
	750W	SME-L07530SAA	SDE-075A2	SDA-CN1	SDH-ENL-5M-L-(T)	SDA-PWCNL1
SME-L Series Low inertia Medium Capacity 2000RPM	1000W	SME-L10020SCA	SDE-100A2	SDA-CN1	SDH-ENM-5M-L-(T)	SDA-PWCNM1
	1500W	SME-L15020SCA	SDE-150A2	SDA-CN1	SDH-ENM-5M-L-(T)	SDA-PWCNM1
	2000W	SME-L20020SCA	SDE-200A2	SDA-CN1	SDH-ENM-5M-L-(T)	SDA-PWCNM1
	3000W	SME-L30020SCA	SDE-300A2	SDA-CN1	SDH-ENM-5M-L-(T)	SDA-PWCNM1
SME-M Series Medium inertia Medium Capacity 2000RPM	1000W	SME-M10020SCA	SDE-100A2	SDA-CN1	SDH-ENM-5M-L-(T)	SDA-PWCNM1
	1500W	SME-M15020SCA	SDE-150A2	SDA-CN1	SDH-ENM-5M-L-(T)	SDA-PWCNM1
	2000W	SME-M20020SCA	SDE-200A2	SDA-CN1	SDH-ENM-5M-L-(T)	SDA-PWCNM2
	3000W	SME-M30020SCA	SDE-300A2	SDA-CN1	SDH-ENM-5M-L-(T)	SDA-PWCNM2

Servo Drive Specifications

Servo Drive Model SDE-□□□A2		010	020	040	075	100	150	200	300	
Main Circuit Power	Input	Voltage 50/60Hz							1-phase or 3-phase AC 200~240V	
		Permissible Voltage Fluctuation 50/60Hz							1-phase or 3-phase AC 170~264V	
		Permissible Frequency Fluctuation							±5%	
	Output	Voltage							AC 0~240V	
		Current	1.0 A	1.8 A	3.2 A	5.8 A	6.4 A	9.4 A	12.1 A	17.6 A
		Frequency							0~250 Hz	
Control Circuit Power	Voltage 50/60Hz							1-phase or 3-phase AC 200~240V		
	Permissible Voltage Fluctuation 50/60Hz							1-phase or 3-phase AC 170~264V		
	Permissible Frequency Fluctuation							±5%		
	Power Consumption (W)							30		
Control Method		3-phase full wave rectify, IGBT-PWM controlled (SVPWM drive)								
Protective Functions		Overcurrent, low voltage, overvoltage, overheat, overload protection, fan failure protection, Abnormal pulse control command, output short circuit protection, encoder error protection, overspeed protection, error excessive protection, Serial communication error, Serial communication time out, Motor match error, short circuit protection of U, V, W, excessive error protection.								
Encoder Feedback		22bit (4,194,304 pulse/rev)								
Communication Interface		RS485 (MODBUS) 、USB								
Position Control Mode	Input pulse frequency	500 kpps Low Speed / 4 Mbps High speed (Line Drive),200 kpps (Open Collector)								
	Command pulse type	CCW Pulse train +CW Pulse train ; Pulse train + Symbols ; A-, B-phase pulse train								
	Command Type	External pulse control / Internal register setup								
	Command Smoothing	Low-pass filter / Linear / S curve								
	Command Pulse Multiplying factor	Electronic gear A/B ratio A : 1~4194304 · B : 1~4194304 (Limitation:1/50 < A/B < 64000)								
	Error Excessive	±3 rotations								
	Torque Limit	Internal parameter setup or external analog Input setup (0~+10 VDC/Maximum torque)								
	Feedforward Compensation	Internal parameter setup 0~200%								
Speed Control Mode	Speed Control Range	Analogue speed command 1:2000; Internal speed command 1:5000								
	Command Type	External analog voltage input / Internal register setup								
	Command Smoothing	Low-pass filter / Linear acceleration and deceleration curve / S curve								
	Analog Speed Command Input	DC 0~±10V/Rated speed (input impedance 10~12kΩ)								
	Speed Fluctuation Rate	Load fluctuation 0~100%(maximum) ±0.01% power fluctuation ±10%(maximum)0.01% Ambient temperature 0°C~55°C : (maximum) ±0.5% (Analog speed command)								
	Torque Limit	Internal parameter setup or external analog Input setup (DC0~+10V / Maximum torque)								
Torque Limitation Mode	Command Type	External analog voltage input								
	Command Smoothing	Low-pass filter								
	Analog Torque Command Input	DC 0~±10V / Maximum torque (input impedance 10~12kΩ)								
	Speed Limit	Internal parameter setup or external analog Input setup (DC 0~±10V / Maximum speed)								
Input and Output Signals	Digital Input	Servo on, forward and backward inhibit limits, pulse error clear, torque directionselection, speed command selection, positioning command selection, forward andbackward rotation direction selection, proportion control switching, torque limit switching,abnormal alarm reset, emergency stop, Forward/Reverse inhibit limit, control mode switching, electric gear ratio selection, gain switching, Position command selection, Position command triggered, Motor stop, Pulse inhibit input, Event trigger command, Homing, Move to "Home".								
	Digital Output	Torque limit reached, speed limit reached, Reserved signal, zero speed reached, position reached, speed reached, Alarm display, alarm signal, Homing completed, Overload level arrive, Internal position command completed, Position command overflow, Forward software limit arrive, Reverse software limit arrive								
	Analog Input	Analog speed command / limit, analog torque command / limit								
	Analog Output	Command pulse frequency, pulse error, current command, DC bus voltage, servo motor speed, torque value								
Environment	Temperature	0°C~55°C (Force air circulation in the surrounding area if the temperature goes beyond 45 °C);Storage: -20~65°C (non freezing)								
	Humidity	Maximum 90% RH (non condensing); Storage: Below 90% RH (non condensing)								
	Installation Location	Indoor (avoid direct sunlight); no corrosive gas, no flammable gas, no oil mist or dust								
	Altitude	Between sea level and 1000 m								
	Vibration	Maximum 5.9m/s ²								
Cooling System		Natural cooling, open				Fan cooling, open				
Weight(kg)		1.4	1.4	1.4	1.7	1.7	2.6	2.6	2.6	

Connections with Peripheral Equipment

Power Supply : 3-phase 200~240V

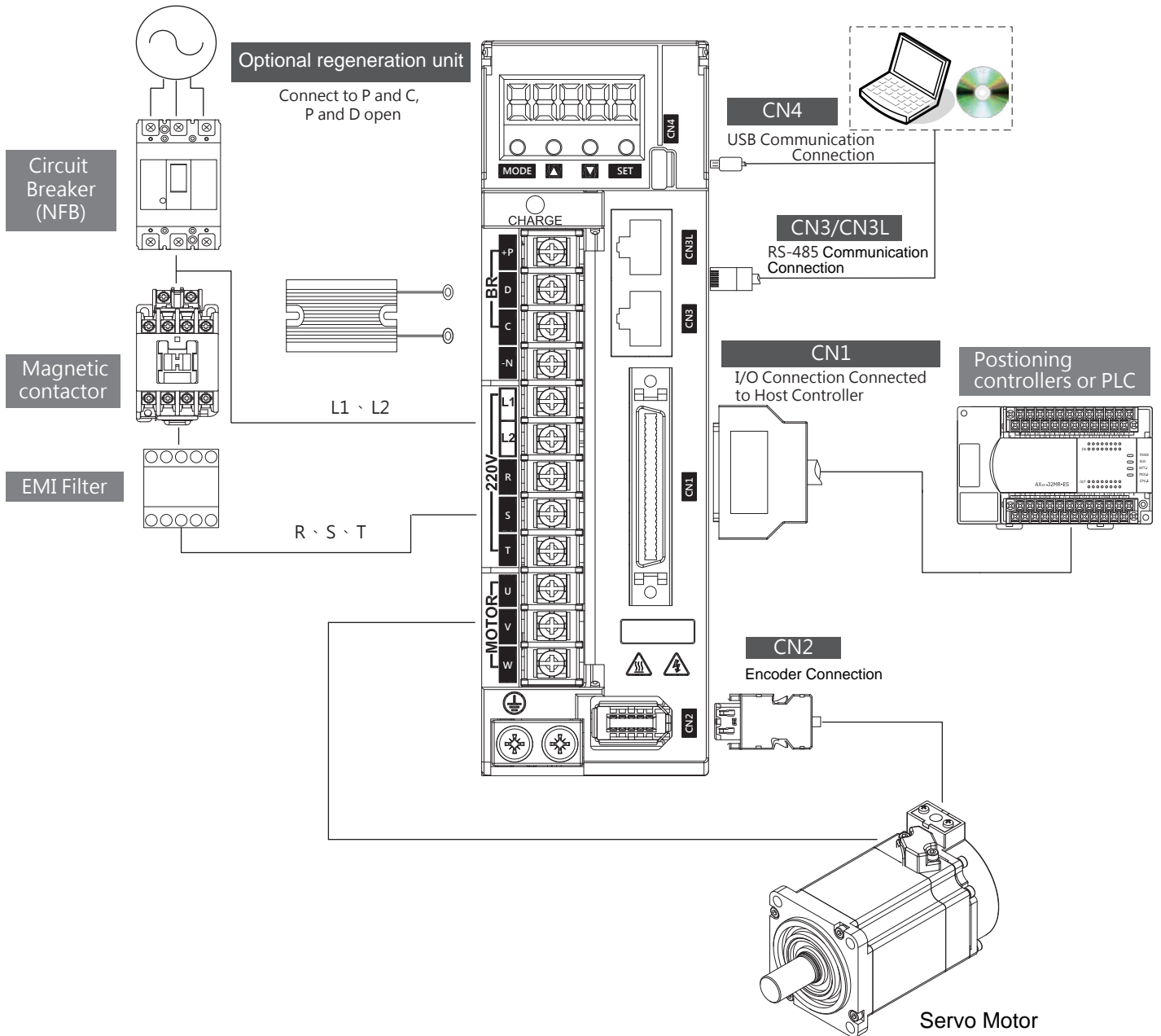

Notes

1. Connect external regeneration unit, please remove P and D short circuit line and connect external resistor to P \ C point. Every capacity has its related resistor value, please refer to "Instruction Manual" .
2. Dedicated power cable is necessary with a brake motor, the exclusive power cable for must be prepared and need to input DC24V power. Please don't use drive internal VDD connector for power. Please refer to "Operation Manual" for details.
3. The usage of absolute position, please select the optional battery "SDH-BAT-SET" .

Servo Drive Dimensions

Unit : mm

SDE-010A2、SDE-020A2、SDE-040A2

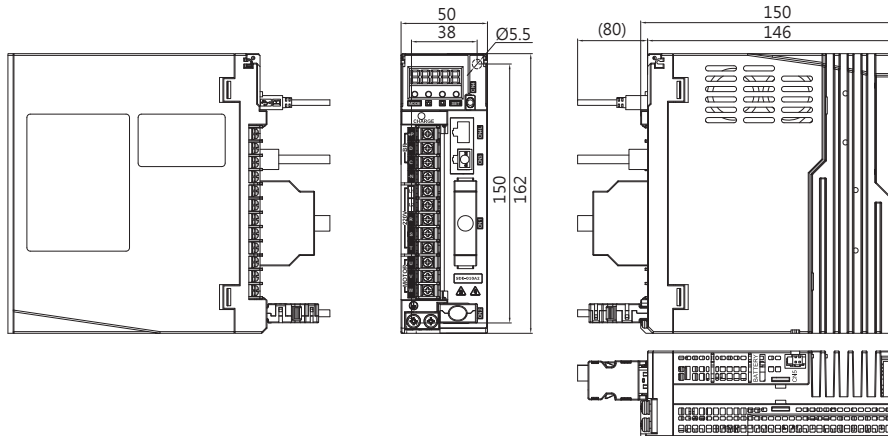

SDE-075A2、SDE-100A2

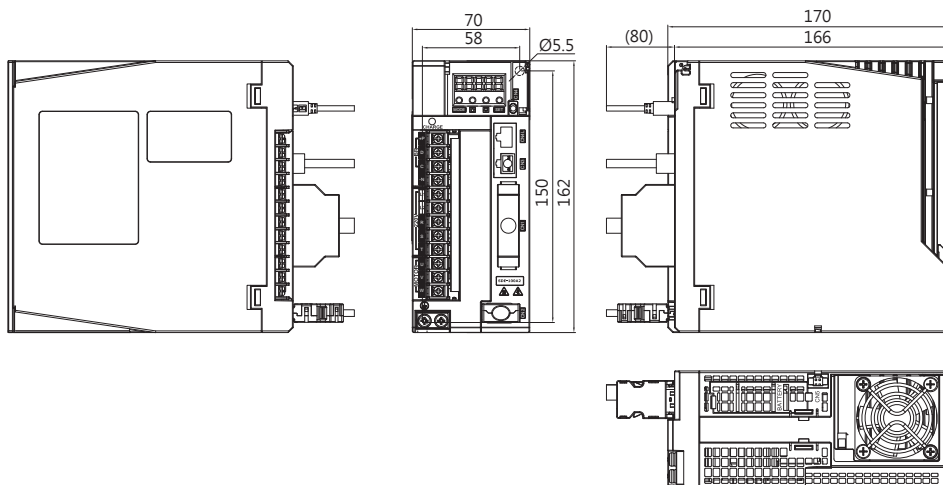

SDE-150A2、SDE-200A2、SDE-300A2

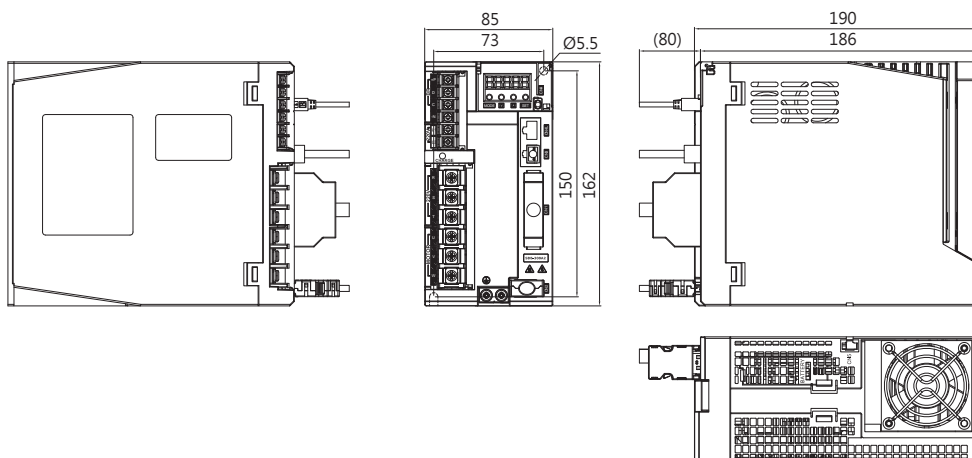

Note : Dimensions and weights of the servo drive may be revised without prior notice.
Please refer to Shihlin official website.

Servo Motor Specifications

Small Capacity, Low inertia

Servo Drive Model SME - L□□□30		Unit	005	010	020	040	075
Compatible servo drive model			Refer to table "Combinations of Servo Motor and Servo Drive"				
Rated output		W	50	100	200	400	750
Rated torque ^(Note1)		Nm	0.16	0.32	0.64	1.27	2.4
Maximum torque		Nm	0.48	0.96	1.92	3.81	7.2
Rated speed		rpm	3000				
Maximum speed		rpm	6000				
Rated current		A	0.43	0.85	1.7	2.8	5.8
Maximum current		A	2.7	2.7	5.2	9.0	18.5
Moment of Inertia with brake J (x10 ⁻⁴) ^(Note2)		kg·m ²	0.0295 (0.0299)	0.0518 (0.0523)	0.161 (0.178)	0.277 (0.294)	1.07 (1.11)
Power rate at continuous rated torque		kW/s	8.6	19.6	25.2	58.5	53.3
Insulation class		--	CE(B) & UL(A)				
Insulation resistance		--	100MΩ @ DC 500V				
Insulation voltage		--	60sec @ AC 1500V				
Encoder resolution		--	Resolution 22bit (4,194,304 Pulse)				
Structure		--	Totally enclosed, natural cooling (IP rating: IP65) ^(Note3)				
Vibration rank		--	V-15				
Environment	Storage temperature	--	0°C ~ 40°C (non freezing) / Storage : -15°C ~ 70°C (non freezing)				
	Storage humidity	--	Below 80%RH (non condensing) / Storage : Below 90%RH (non condensing)				
	Altitude	--	Between sea level and 1000 m				
	Ambience	--	Indoor (avoid direct sunlight); no corrosive gas, no flammable gas, no oil mist or dust				
	Vibration Resistance	--	5G				
Permissible load for the shaft	Fd	mm	20		25		35
	Radial load Fr	N	68.6		245		392
	Axial load Fa	N	39.2		98		147
Electromagnetic Brake Specifications ^(Note4)	Input voltage	V	DC 24V ± 10%				
	Brake torque	Nm	0.3		1.3		2.4
	Power consumption	W	6.3		7.9		8.6
	Current consumption	A	0.24		0.32		0.35
	Resistor@20°C	Ω	92.4		75.4		67
	Open time	ms	20		30		50
	Close time	ms	20		20		20
Weight		kg	0.33 (0.55)	0.45 (0.67)	0.85 (1.23)	1.23 (1.59)	2.24 (2.87)

Note1 : When unbalanced torque is generated, such as in a vertical lift machine, keep the unbalanced torque of the machine under 75% of the servo motor rated torque.

Note2 : () Values in brackets are for the models with electromagnetic brake.

Note3 : The shaft-through portion, the connector, and the power cable leading part are excluded.

Note4 : The electromagnetic brake is for holding. It should not be used for deceleration applications.

Servo Motor Specifications

Medium Capacity, Low inertia

Servo Motor Model SME - L□□□20	Unit	100	150	200	300
Compatible servo drive model		Refer to table "Combinations of Servo Motor and Servo Drive"			
Rated output	W	1000	1500	2000	3000
Rated torque ^(Note1)	Nm	4.78	7.16	9.55	14.3
Maximum torque	Nm	14.4	21.6	28.5	43.0
Rated speed	rpm	2000			
Maximum speed	rpm	3500			
Rated current	A	5.8	8.5	11	16
Maximum current	A	17.4	25.2	33	48
Moment of Inertia with brake $J(x10^{-4})$ ^(Note2)	kg·m ²	6.1 (8.0)	8.8 (10.7)	11.5 (13.5)	16.7 (18.7)
Power rate at continuous rated torque	kW/s	37.6	58.3	79.3	122.9
Insulation class	--	CE(F) / CE(B) & UL(A) (UL approval is optional)			
Insulation resistance	--	100MΩ @ DC 500V			
Insulation voltage	--	60sec @ AC 1500V			
Encoder resolution	--	Resolution 22bit (4,194,304 Pulse)			
Structure ^(Note3)	--	Totally enclosed, natural cooling (IP rating: IP65)			
Vibration rank	--	V-15			
Environment	Storage temperature	--	0°C ~ 40°C(non freezing) / Storage : -15°C ~ 70°C (non freezing)		
	Storage humidity	--	Below 80%RH (non condensing) / Storage : Below 90%RH (non condensing)		
	Altitude	--	Between sea level and 1000 m		
	Ambience	--	Indoor (avoid direct sunlight); no corrosive gas, no flammable gas, no oil mist or dust		
	Vibration Resistance	--	2.5G		
Permissible load for the shaft	Fd	mm	50		
	Radial load Fr	N	490		
	Axial load Fa	N	196		
Electromagnetic Brake Specifications ^(Note4)	Input voltage	V	DC 24V ± 10%		
	Brake torque	Nm	8.5	15	
	Power consumption	W	19.3	19.3	
	Current consumption	A	0.8	0.8	
	Resistor@20°C	Ω	29.8	29.8	
	Open time	ms	40	40	
	Close time	ms	25	25	
Weight ^(Note5)	kg	5.2/5.6 (7.0/7.4)	6.5/6.9 (8.3/8.7)	7.7/8.1 (9.5/9.9)	10.2/10.6 (12.0/12.4)

Note 1: When unbalanced torque is generated, such as in a vertical lift machine, keep the unbalanced torque of the machine under 75% of the servo motor rated torque.

Note 2: () Values in brackets are for the models with electromagnetic brake.

Note 3: The shaft-through portion, the connector, and the power cable leading parts are excluded.

Note 4: The electromagnetic brake is for holding. It should not be used for deceleration applications.

Note 5: Values for CE Certification/Values for CE and UL Certification ; (/) Values in brackets are for the models with electromagnetic brake.

■ Medium Capacity, Medium inertia

Servo Motor Model SME - M□□□20		Unit	100	150	200	300
Compatible servo drive model			Refer to table "Combinations of Servo Motor and Servo Drive"			
Rated output		W	1000	1500	2000	3000
Rated torque ^(Note1)		Nm	4.78	7.16	9.55	14.3
Maximum torque		Nm	14.4	21.6	28.5	43.0
Rated speed		rpm	2000			
Maximum speed		rpm	3500			
Rated current		A	5.8	8.5	11	16
Maximum current		A	17.4	25.2	34.7	48
Moment of Inertia with brake J ($\times 10^{-4}$) ^(Note2)		kg·m ²	10.3 (12.2)	15.0 (17.0)	32.1 (42.4)	61.2 (71.6)
Power rate at continuous rated torque		kW/s	22.1	34.2	28.4	33.5
Insulation class		--	CE(F) / CE(B) & UL(A) (UL approval is optional)			
Insulation resistance		--	100M Ω @ DC 500V			
Insulation voltage		--	60sec @ AC 1500V			
Encoder resolution		--	Resolution 22bit (4,194,304 Pulse)			
Structure ^(Note3)		--	Totally enclosed, natural cooling (IP rating: IP65)			
Vibration rank		--	V-15			
Environment	Storage temperature	--	0°C ~ 40°C (non freezing) / Storage : -15°C ~ 70°C (non freezing)			
	Storage humidity	--	Below 80%RH (non condensing) / Storage : Below 90%RH (non condensing)			
	Altitude	--	Between sea level and 1000 m			
	Ambience	--	Indoor (avoid direct sunlight); no corrosive gas, no flammable gas, no oil mist or dust			
	Vibration Resistance	--	2.5G			
Permissible load for the shaft	Fd	mm	50		70	
	Radial load Fr	N	490		980	
	Axial load Fa	N	196		392	
Electromagnetic Brake Specifications ^(Note4)	Input voltage	V	DC 24V \pm 10%			
	Brake torque	Nm	8.5		45	
	Power consumption	W	19.3		34	
	Current consumption	A	0.8		1.41	
	Resistor@20°C	Ω	29.8		17	
	Open time	ms	40		110	
	Close time	ms	25		30	
Weight ^(Note5)	kg	5.6/5.8 (7.4/7.6)	6.9/7.2 (8.7/9.0)	10.5/11.0 (15.8/16.3)	15.3/15.8 (20.6/21.1)	

Note 1: When unbalanced torque is generated, such as in a vertical lift machine, keep the unbalanced torque of the machine under 75% of the servo motor rated torque.

Note 2: () Values in brackets are for the models with electromagnetic brake.

Note 3: The shaft-through portion, the connector, and the power cable leading parts are excluded.

Note 4: The electromagnetic brake is for holding. It should not be used for deceleration applications.

Note 5: Values for CE Certification/Values for CE and UL Certification ; (/) Values in brackets are for the models with electromagnetic brake.

Servo Motor Torque Characteristic

SME-L□□□30 series Torque Characteristics *

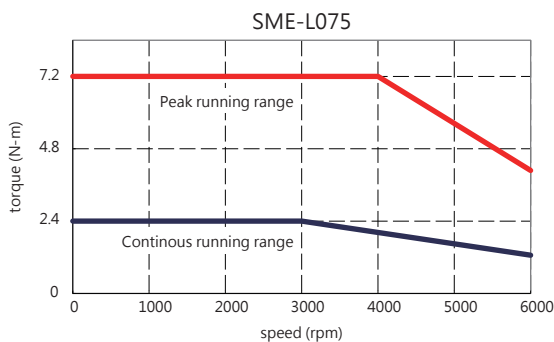
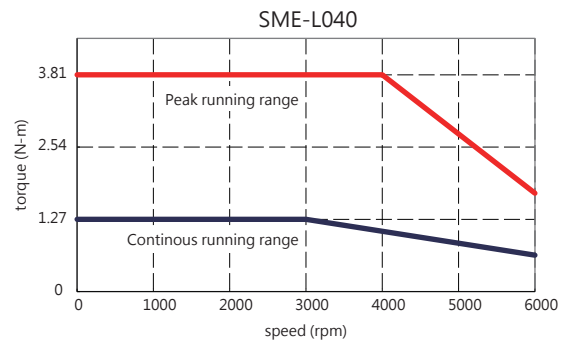
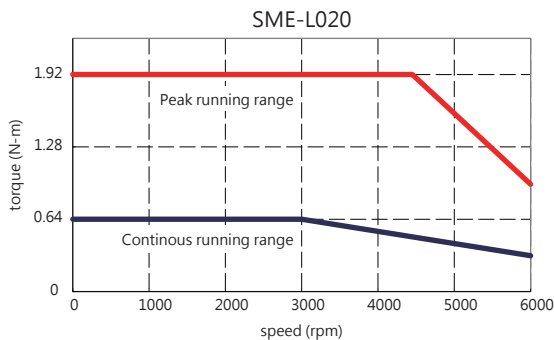
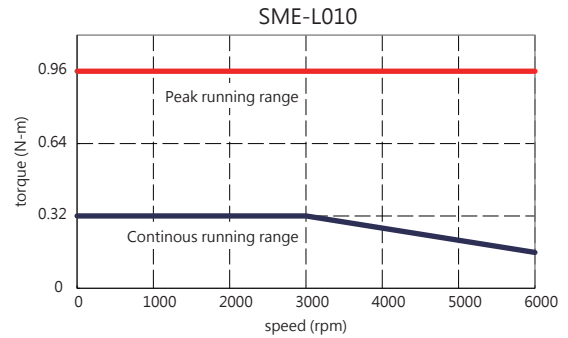
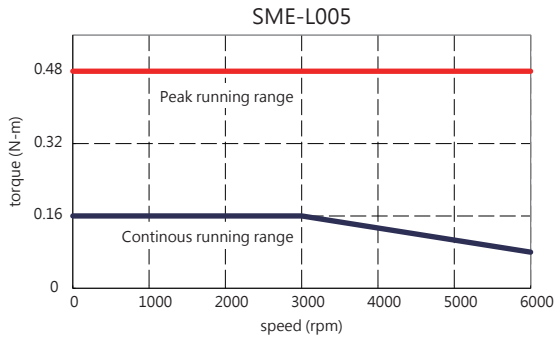

*For 3-phase 220 V and torque drops when the power supply voltage is below the specified value.

SME-L□□□20series Torque Characteristics *

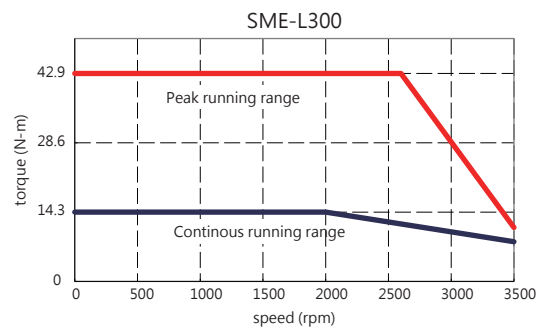
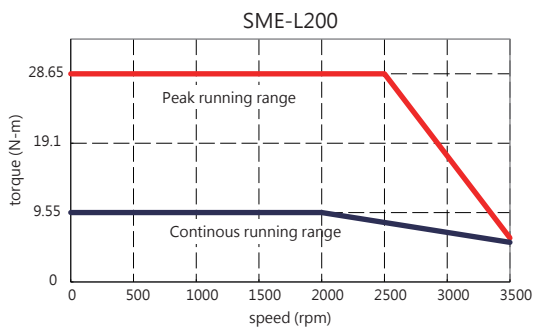
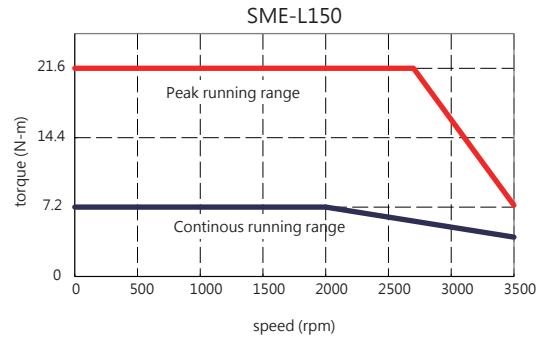
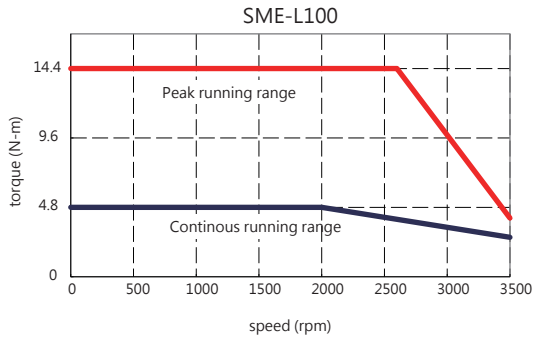

*For 3-phase 220 V and torque drops when the power supply voltage is below the specified value.

SME-M□□□20series Torque Characteristics *

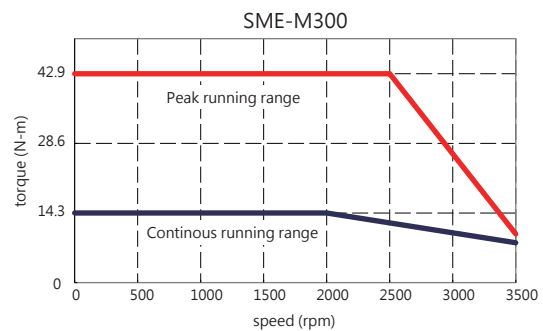
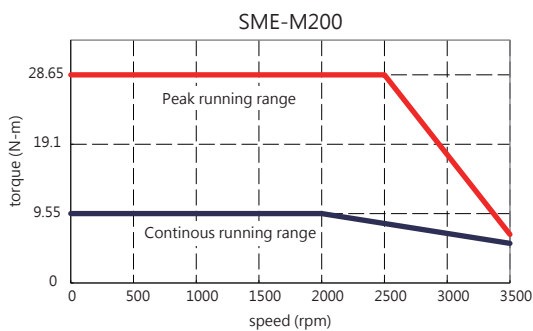
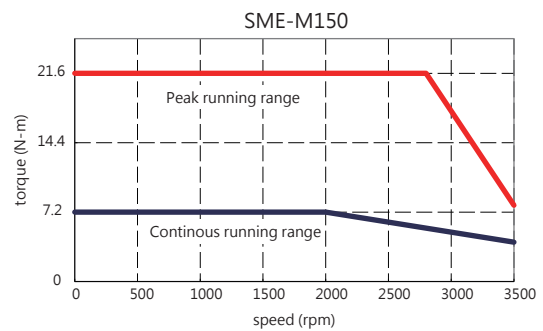
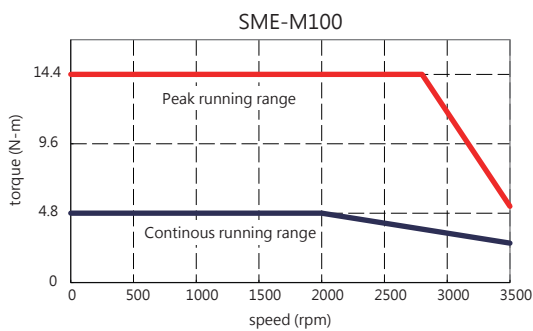

*For 3-phase 220 V and torque drops when the power supply voltage is below the specified value.

Servo Motor Dimensions

Small Capacity, Low inertia SME - L□□□30

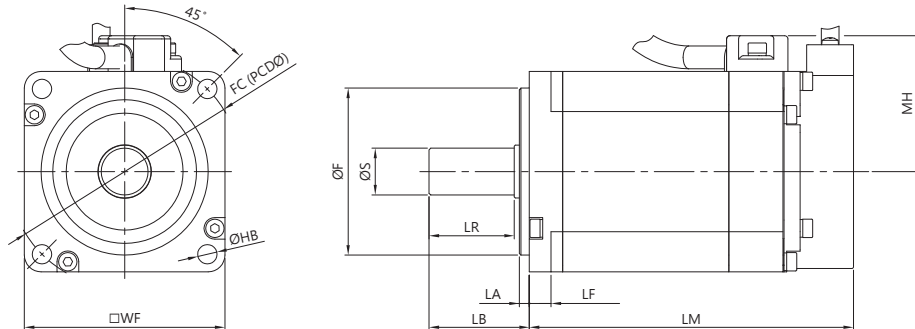

Model	Variable dimensions (mm)										
	WF	ϕS	ϕF	LA	LB	LF	LR	MH	LM*	FC	HB
SME-L005	40	$\phi 8^{0}_{-0.009}$	$\phi 30^{0}_{-0.03}$	2.5	25	5.5	21.5	32	64.5 (99.2)	46	2- $\phi 4.5$
SME-L010									80.0 (114.7)		
SME-L020	60	$\phi 14^{0}_{-0.011}$	$\phi 50^{0}_{-0.03}$	3	30	6.5	25	42	77.0 (112)	70	4- $\phi 5.8$
SME-L040									97.0 (132)		
SME-L075	80	$\phi 19^{0}_{-0.013}$	$\phi 70^{0}_{-0.03}$	3	40	7.5	35.5	52	101.2 (140.2)	90	4- $\phi 6.6$

*() Dimensions in brackets are for the models with electromagnetic brake.

Medium Capacity, Low inertia SME-L□□□20

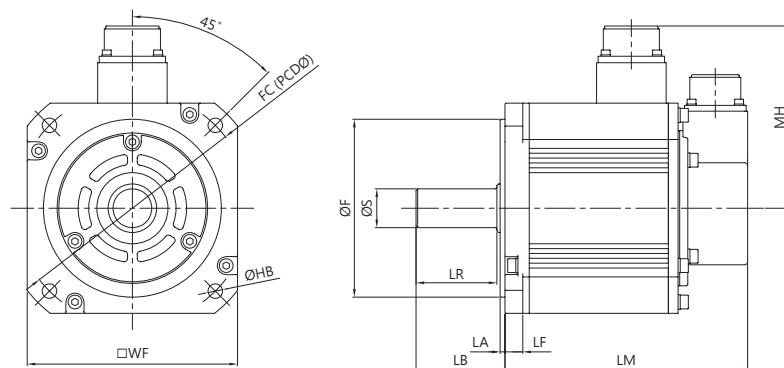

Model	Variable dimensions (mm)										
	WF	ϕS	ϕF	LA	LB	LF	LR	MH	LM*	FC	HB
SME-L100	130	$\phi 24^{0}_{-0.013}$	$\phi 110^{0}_{-0.035}$	3	55	11	50	113	127 (161)	145	4- $\phi 9.0$
SME-L150									141.5 (175.5)		
SME-L200									156 (190)		
SME-L300									185 (219)		

*() Dimensions in brackets are for the models with electromagnetic brake.

Medium Capacity, Medium inertia SME-M□□□20

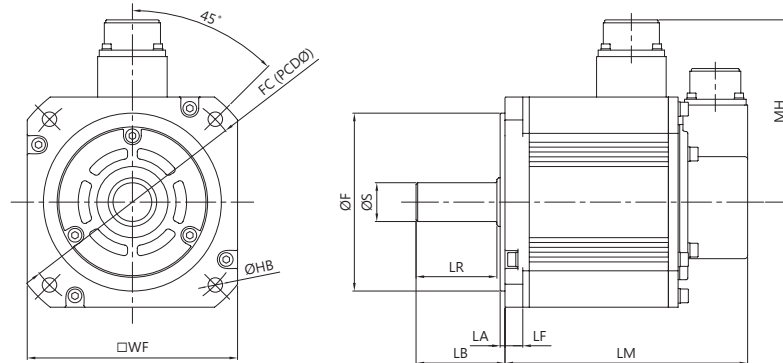

Model	Variable dimensions (mm)										
	WF	ϕS	ϕF	LA	LB	LF	LR	MH	LM*	FC	HB
SME-M100	130	$\phi 24 \begin{smallmatrix} 0 \\ -0.013 \end{smallmatrix}$	$\phi 110 \begin{smallmatrix} 0 \\ -0.035 \end{smallmatrix}$	3	55	11	50	113	127	145	4- $\phi 9.0$
SME-M150									(161)		
SME-M200	176	$\phi 35 \begin{smallmatrix} 0 \\ -0.016 \end{smallmatrix}$	$\phi 114.3 \begin{smallmatrix} 0 \\ -0.025 \end{smallmatrix}$	3	78	18.5	74	139	139	200	4- $\phi 13.5$
SME-M300									(189)		
									169		
									(219)		

*() Dimensions in brackets are for the models with electromagnetic brake.

Motor Shaft Dimensions

D-cut for L005 / L010

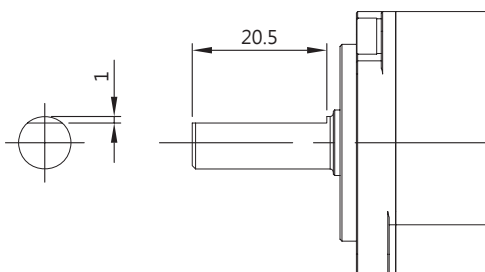

Key-way

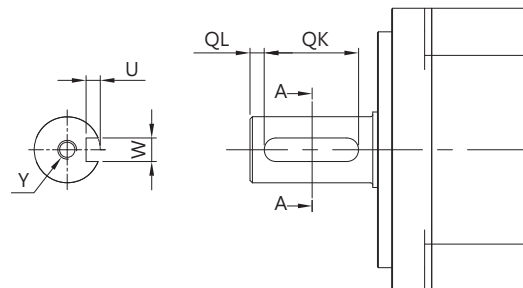

Model	Variable dimensions (mm)				
	QL	QK	W	U	Y
L020 \ L040	3	20	$5 \begin{smallmatrix} 0 \\ -0.03 \end{smallmatrix}$	3	M4 x depth 15
L075	5	25	$6 \begin{smallmatrix} 0 \\ -0.03 \end{smallmatrix}$	3.5	M5 x depth 20
L100 \ L150 \ L200 \ L300 M100 \ M150	5	35	$8 \begin{smallmatrix} 0 \\ -0.036 \end{smallmatrix}$	4	M8 x depth 20
M200 \ M300	5	55	$10 \begin{smallmatrix} 0 \\ -0.036 \end{smallmatrix}$	5	M8 x depth 20

Wiring Diagram

Pr Mode: Built-in Single-axis Control Mode

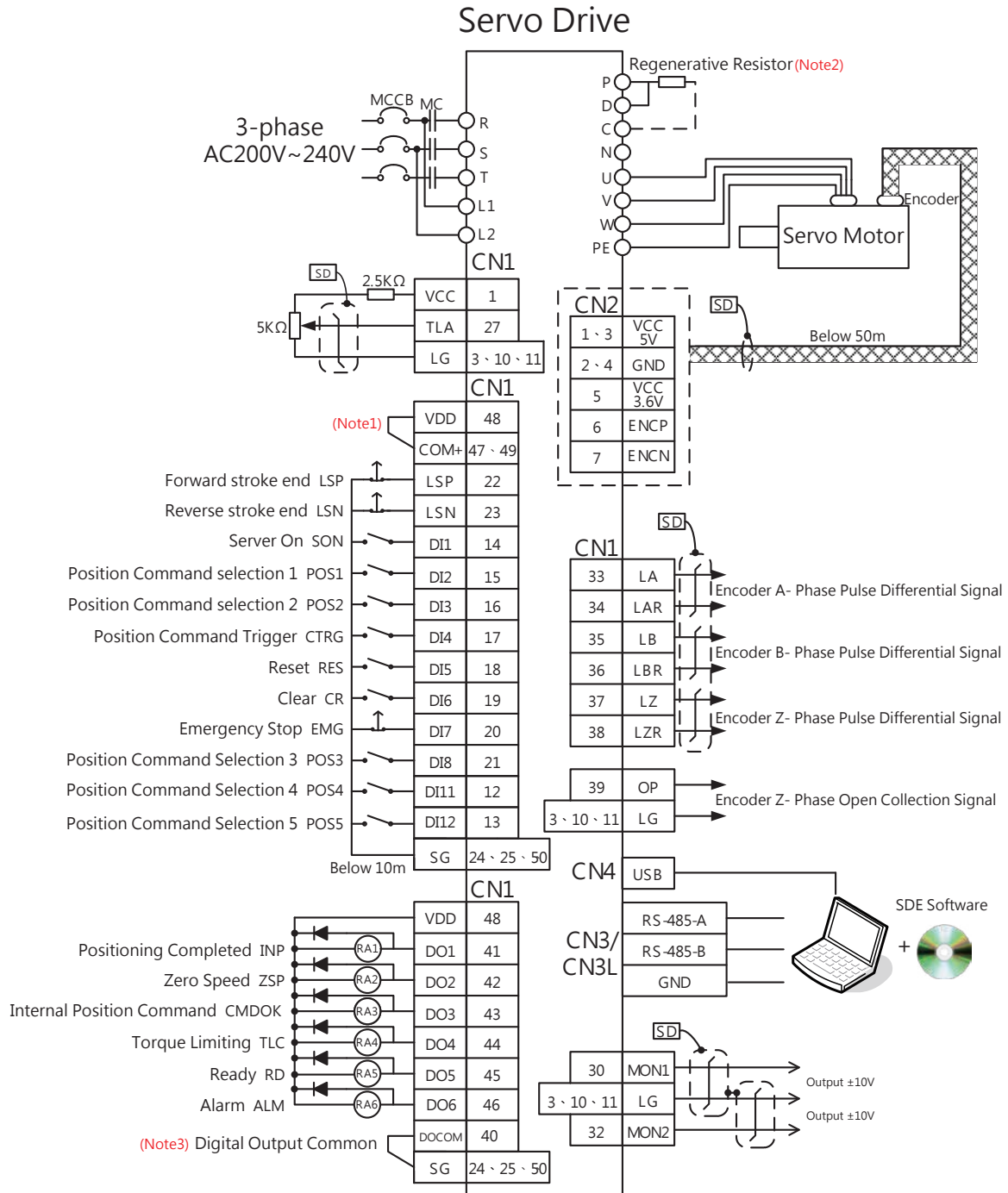

Notes

- Note 1:** If external power is used, VDD can not be connected to COM +.
- Note 2:** Please refer to the manual for the wiring of regenerative resistance and brake units.
- Note 3:** Please refer to the wiring of manual when DO output Sink Type or Sourc Type.

Pt Mode:Position Control Mode

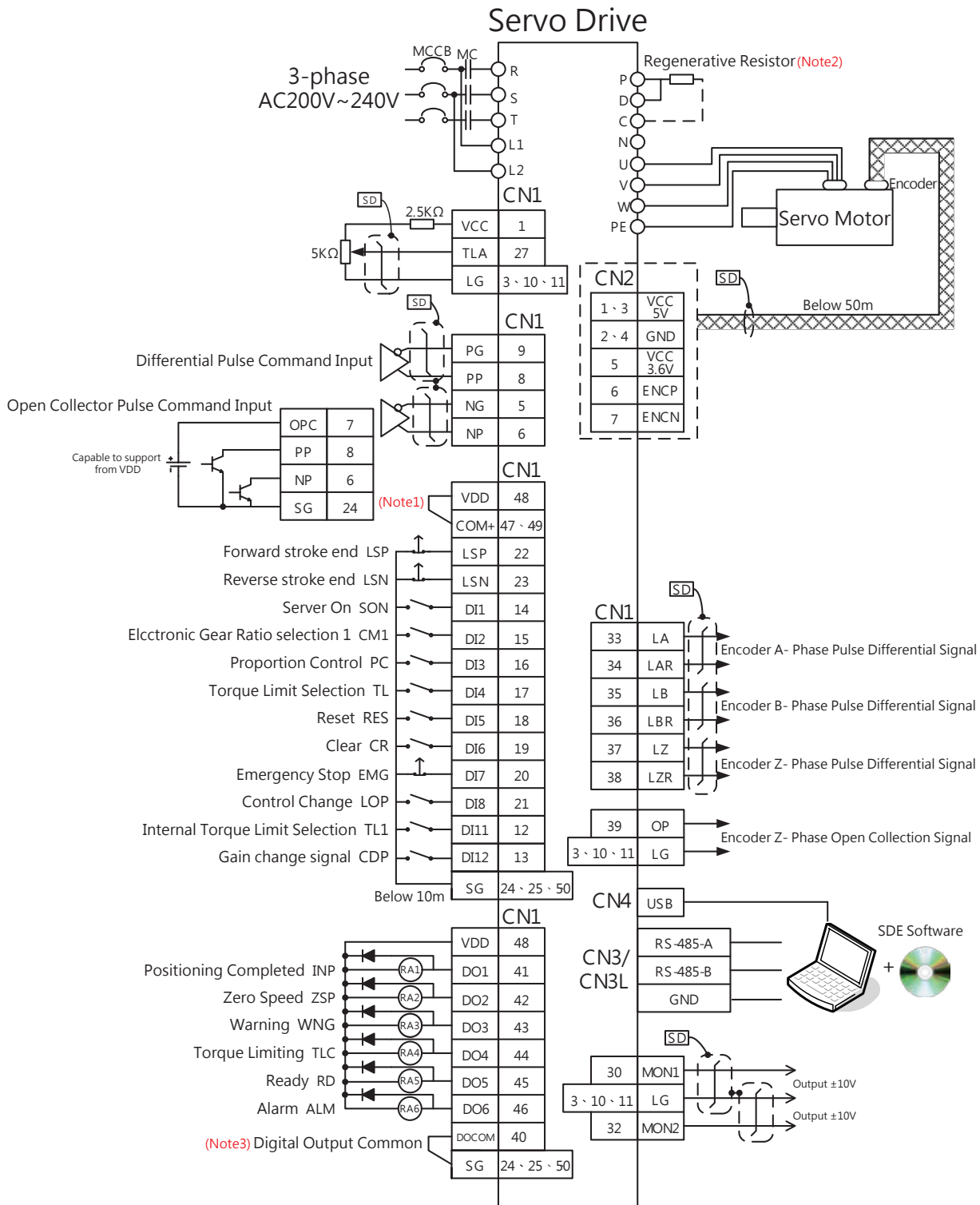

Notes

- Note 1 :** If external power is used, VDD can not be connected to COM +.
- Note 2 :** Please refer to the manual for the wiring of regenerative resistance and brake units.
- Note 3 :** Please refer to the wiring of manual when DO output Sink Type or Sourc Type.

Wiring Diagram

S Mode: Speed Control Mode

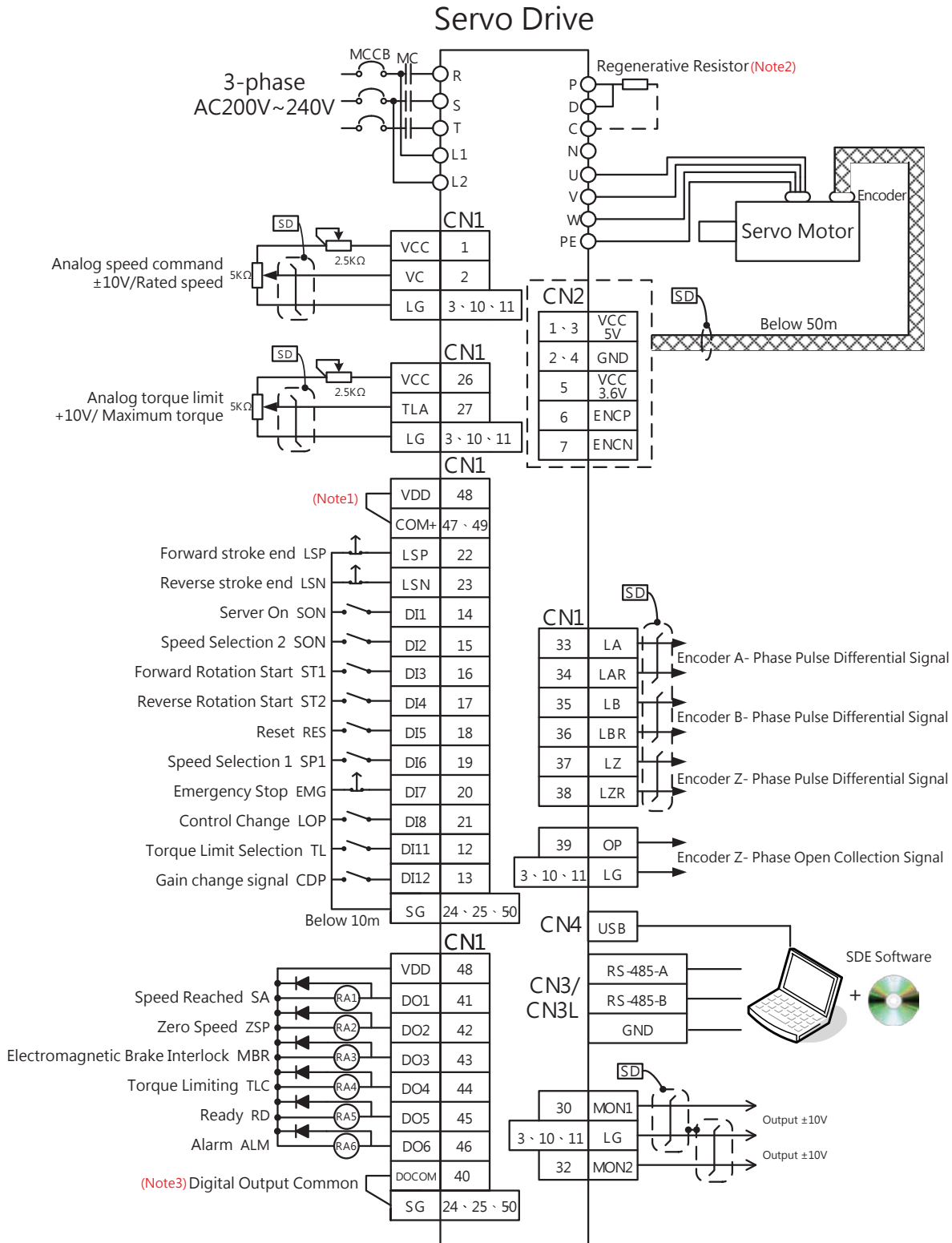

Notes

Note 1 : If external power is used, VDD can not be connected to COM +.

Note 2 : Please refer to the manual for the wiring of regenerative resistance and brake units.

Note 3 : Please refer to the wiring of manual when DO output Sink Type or Sourc Type.

T Mode: Torque Control Mode

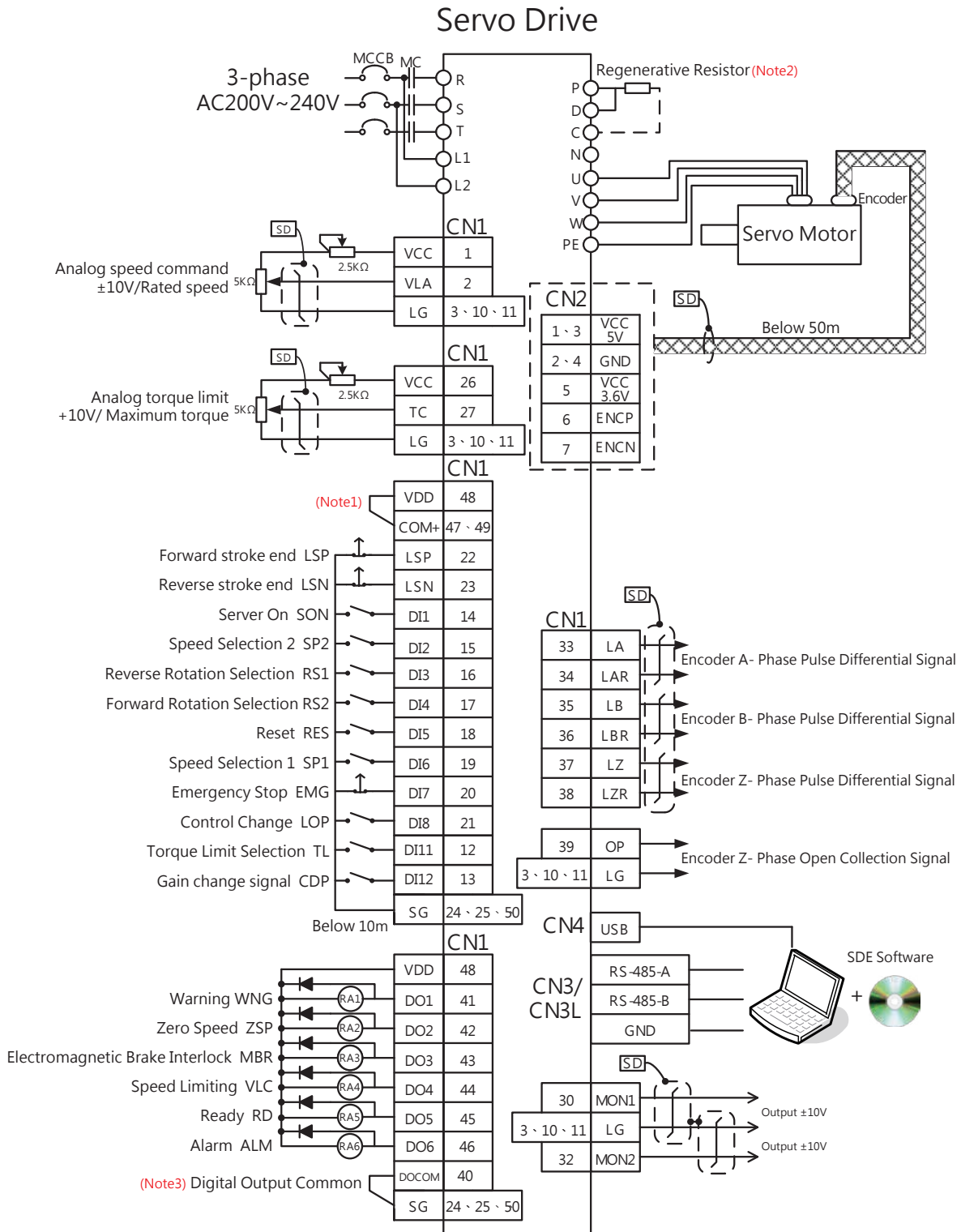

Notes

- Note 1 :** If external power is used, VDD can not be connected to COM +.
- Note 2 :** Please refer to the manual for the wiring of regenerative resistance and brake units.
- Note 3 :** Please refer to the wiring of manual when DO output Sink Type or Sourc Type.

Optional Accessories

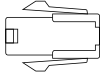
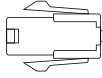
Model	Motor Connector	Model ^{*1*2}	Motor Cable
SDA-PWCNL1	 <p>Power connector Part No : (Housing) Molex 5559-04P-210 (Connector) Molex5558T</p>	SDA-PWCNL1-□M-L SDA-PWCNL1-□M-H	 <p>Power Cable Part No : (Housing) Molex 5559-04P-210 (Cable clamp) Molex5558T</p>

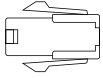
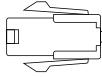
Model	Motor Connector for Brake type	Model ^{*1*2}	Motor Cable for Brake type
SDA-PWCNL2	 <p>Power connector Model : (Housing) Molex 5559-06P-210 (Cable clamp) Molex5558T</p>	SDA-PWCNL2-□M-L SDA-PWCNL2-□M-H	 <p>Power Cable for Brake type Part No : (Housing) Molex 5559-06P-210 (Cable clamp) Molex5558T</p>

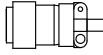
Model	Motor Connector
SDA-PWCNM1	 <p>Power Connector Part No : MS3106A22-23S</p>

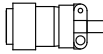
Model ^{*1*2}	Motor Cable
SDA-PWCNM1-□M-L SDA-PWCNM1-□M-H	 <p>Power Cable</p>

Model ^{*1*2}	Motor Cable
SDA-PWCNM1B-□M-L SDA-PWCNM1B-□M-H	 <p>Power Cable for Brake type</p>

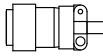
Model	Motor Connector
SDA-PWCNM2	 <p>Power Connector Part No : MS3106A24-10S</p>

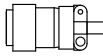
Model ^{*1*2}	Motor Cable
SDA-PWCNM2-□M-L SDA-PWCNM2-□M-H	 <p>Motor Cable</p>

Model ^{*1*2}	Motor Cable
SDA-PWCNM2B-□M-L SDA-PWCNM2B-□M-H	 <p>Power cable for Brake type</p>

*1 : □ Indicates the cable length. Standard: 2M · 3M · 5M · 10M; Special order: other length

*2 : L and H indicate bending life. L: standard, H: long bending life.

※ It is recommended to use the same Part No as the above table ◦

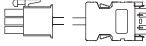
Model	50W-750W Motor Encoder Connector	Model ^{*1*2}	50W-750W Motor Encoder Cable
SDH-ENL	 <p>Encoder connector for CN2 Part No : Motor side (Housing) AMP 1-172161-9 (Cable clamp) AMP 170360-1 Drive side (Housing) XM-10P</p>	 <p>Encoder cable Part No : Motor side (Housing) AMP 1-172161-9 (Cable clamp) AMP 170360-1 Drive side (Connector) XM-10P</p>	

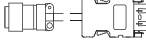
Model	1KW-3KW Motor Encoder Connector	Model ^{*1*2}	1KW-3KW Motor Encoder Cable
SDH-ENM	 <p>Encoder connector for CN2 Part No : MS3106A20-18S XM-10P</p>	 <p>Encoder cable Part No : MS3106A20-18S XM-10P</p>	

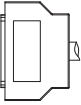
Model	CN1 I/O Connector	
SDA-CN1		<p>I/O Connector General type Spec : (Cable clamp) Standard SCSI-2 spec</p>

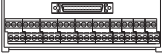
Model	CN1 Terminal Block	
SDA-TB50		<p>CN1 Terminal Block General type Spec : (Cable clamp) Standard SCSI-2 spec</p>

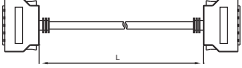
Model ^{*1}	CN1 Terminal Block Cable	
SDA-TBL□M		<p>CN1 Terminal Block cable General type Spec : (Cable clamp) Standard SCSI-2 spec</p>

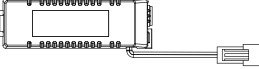
Model	Absolute Encoder Battery Set	
SDH-BAT-SET		<p>Absolute Encoder Battery Set Part No : (Cable clamp) CSM-H250F-2</p>

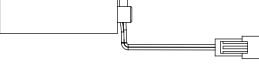
Model	Absolute Encoder Battery	
SDH-BAT		<p>Absolute Encoder Battery Spec : (Cable clamp) CSM-H250F-2</p>

Model	USB Communication Cable	
SDA-USB3M		<p>CN4-USB Communication line General type Spec : (Cable clamp) Standard USB spec</p>

**Head Office:**

16F, No. 88, Sec. 6, ChungShan N. Rd.,
Taipei, Taiwan, 111

TEL: +886-2-2834-2662

FAX: +886-2-2836-6187

HsinFun Factory (Taiwan)

No.234, ChungLun, HsinFun,
HsinChu, Taiwan, 304

TEL: +886-3-599-5111

FAX: +886-3-590-2167

SuZhou Factory (China)

No.88, Guangdong Street, Suzhou New District,
Jiangsu, China, 215129

TEL: +86-512-6843-2662

FAX: +86-512-6831-1917

Official website www.seec.com.tw

Automation Division website automation.seec.com.tw

automation@seec.com.tw

Specification in this catalog are subject to change without notice for ongoing product modification and improvements.

© 2020 Shihlin Electric & Engineering Corporation. All rights reserved. B201020E.SDE-BO3